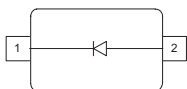
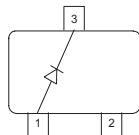
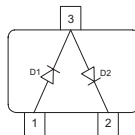
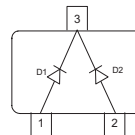
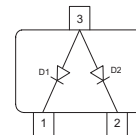
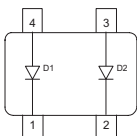

Silicon Schottky Diode

- General-purpose diode for high-speed switching
- Circuit protection
- Voltage clamping
- High-level detecting and mixing
- Pb-free (RoHS compliant) package
- Qualified according AEC Q101¹⁾

BAS140W
BAS40-02L

BAS40

BAS40-04

BAS40-05
BAS40-05W

BAS40-06
BAS40-06W

BAS40-07
BAS40-07W

ESD (Electrostatic discharge) sensitive device, observe handling precaution!

| Type | Package | Configuration | Marking |
|------------|----------|------------------|---------|
| BAS140W | SOD323 | single | white 4 |
| BAS40 | SOT23 | single | 43s |
| BAS40-02L* | TSLP-2-1 | single, leadless | FF |
| BAS40-04 | SOT23 | series | 44s |
| BAS40-05 | SOT23 | common cathode | 45s |
| BAS40-05W | SOT323 | common cathode | 45s |
| BAS40-06 | SOT23 | common anode | 46s |
| BAS40-06W | SOT323 | common anode | 46s |
| BAS40-07 | SOT143 | parallel pair | 47s |
| BAS40-07W | SOT343 | parallel pair | 47s |

¹⁾ BAS40-02L is not qualified according AEC Q101

Maximum Ratings at $T_A = 25\text{ °C}$, unless otherwise specified

| Parameter | Symbol | Value | Unit |
|-------------------------------------------------------------------------------------------------------------------------------------------------------------------------------------------------------------------------------------------------------------------------------------------------------------------------------------------------|-----------|------------------------------------------------------|------|
| Diode reverse voltage | V_R | 40 | V |
| Forward current | I_F | 120 | mA |
| Non-repetitive peak surge forward current $t \leq 10\text{ms}$ | I_{FSM} | 200 | |
| Total power dissipation BAS140W, $T_S \leq 113\text{°C}$ BAS40, BAS40-07, $T_S \leq 81\text{°C}$ BAS40-02L, $T_S \leq 127\text{°C}$ BAS40-04, BAS40-06, $T_S \leq 56\text{°C}$ BAS40-06W, $T_S \leq 106\text{°C}$ BAS40-05, $T_S \leq 31\text{°C}$ BAS40-05W, $T_S \leq 98\text{°C}$ BAS40-07W, $T_S \leq 118\text{°C}$ | P_{tot} | 250 250 250 250 250 250 250 250 | mW |
| Junction temperature | T_j | 150 | |
| Operating temperature range | T_{op} | -55 ... 150 | |
| Storage temperature | T_{stg} | -55 ... 150 | |

Thermal Resistance

| Parameter | Symbol | Value | Unit |
|--------------------------------------------------------------------------------------------------------------------------------------------------------------|------------|-------------------------------------------------------------------------------------------------------------|------|
| Junction - soldering point ¹⁾ BAS140W BAS40, BAS40-07 BAS40-02L BAS40-04, BAS40-06 BAS40-06W BAS40-05 BAS40-05W BAS40-07W | R_{thJS} | ≤ 150 ≤ 275 ≤ 90 ≤ 375 ≤ 175 ≤ 475 ≤ 205 ≤ 125 | K/W |

¹⁾For calculation of R_{thJA} please refer to Application Note AN077 (Thermal Resistance Calculation)

Electrical Characteristics at $T_A = 25^\circ\text{C}$, unless otherwise specified

| Parameter | Symbol | Values | | | Unit |
|-------------------------------------------------------------------------------------------|--------------|-------------------|-------------------|--------------------|---------------|
| | | min. | typ. | max. | |
| DC Characteristics | | | | | |
| Breakdown voltage $I_{(BR)} = 10 \mu\text{A}$ | $V_{(BR)}$ | 40 | - | - | V |
| Reverse current $V_R = 30 \text{ V}$ | I_R | - | - | 1 | μA |
| Forward voltage $I_F = 1 \text{ mA}$ $I_F = 10 \text{ mA}$ $I_F = 40 \text{ mA}$ | V_F | 250 350 600 | 310 450 720 | 380 500 1000 | mV |
| Forward voltage matching ¹⁾ $I_F = 10 \text{ mA}$ | ΔV_F | - | - | 20 | |
| AC Characteristics | | | | | |
| Diode capacitance $V_R = 0, f = 1 \text{ MHz}$ | C_T | - | 3 | 5 | pF |
| Differential forward resistance $I_F = 10 \text{ mA}, f = 10 \text{ kHz}$ | R_F | - | 10 | - | Ω |
| Charge carrier life time $I_F = 25 \text{ mA}$ | τ_{rr} | - | - | 100 | ps |

¹⁾ ΔV_F is the difference between lowest and highest V_F in a multiple diode component.

Diode capacitance $C_T = f(V_R)$

$f = 1\text{MHz}$

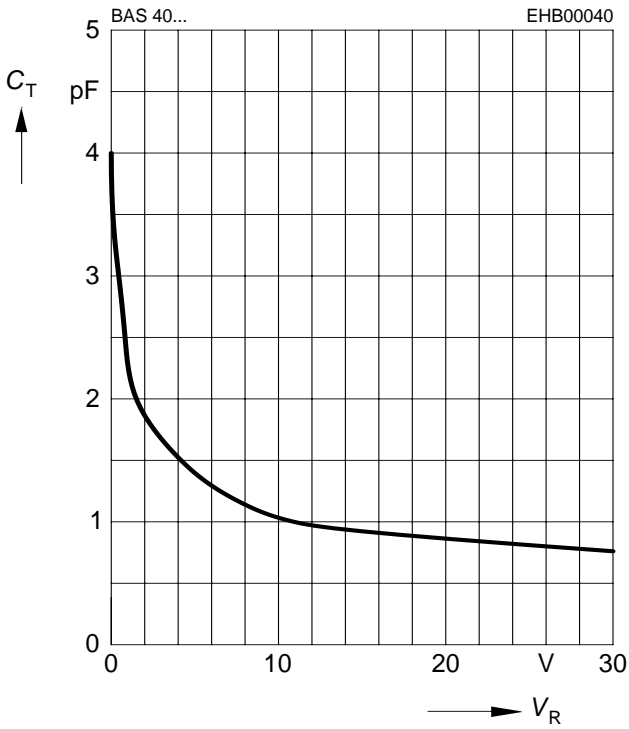

Forward resistance $r_f = f(I_F)$

$f = 10\text{kHz}$

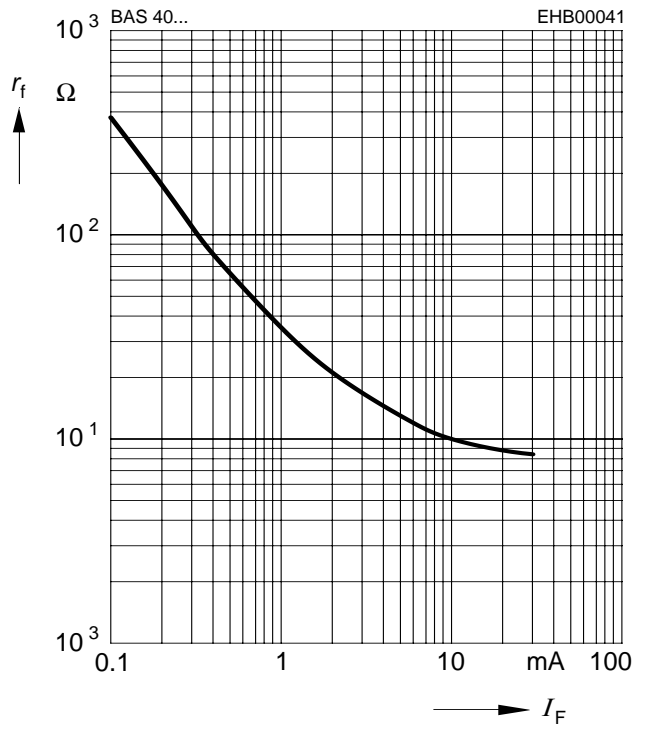

Reverse current $I_R = f(T_A)$

$V_R = \text{Parameter}$

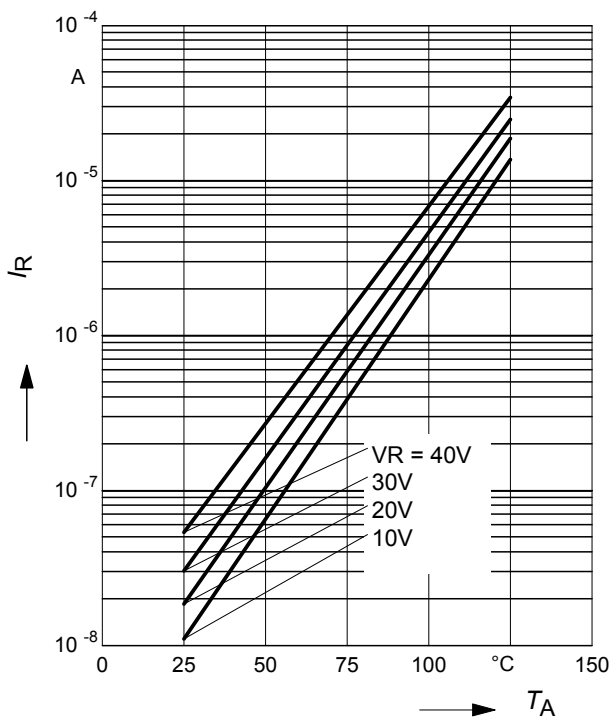

Reverse current $I_R = f(V_R)$

$T_A = \text{Parameter}$

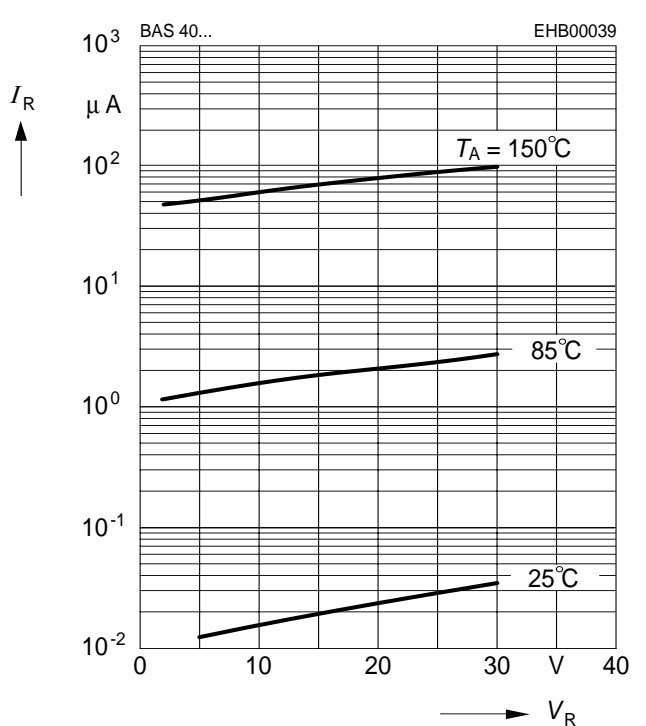

Forward Voltage $V_F = f(T_A)$

$I_F = \text{Parameter}$

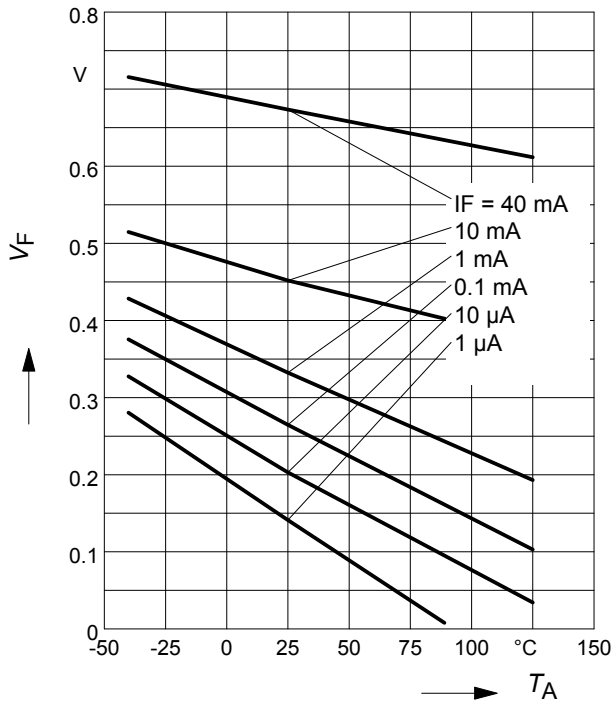

Forward current $I_F = f(V_F)$

$T_A = \text{Parameter}$

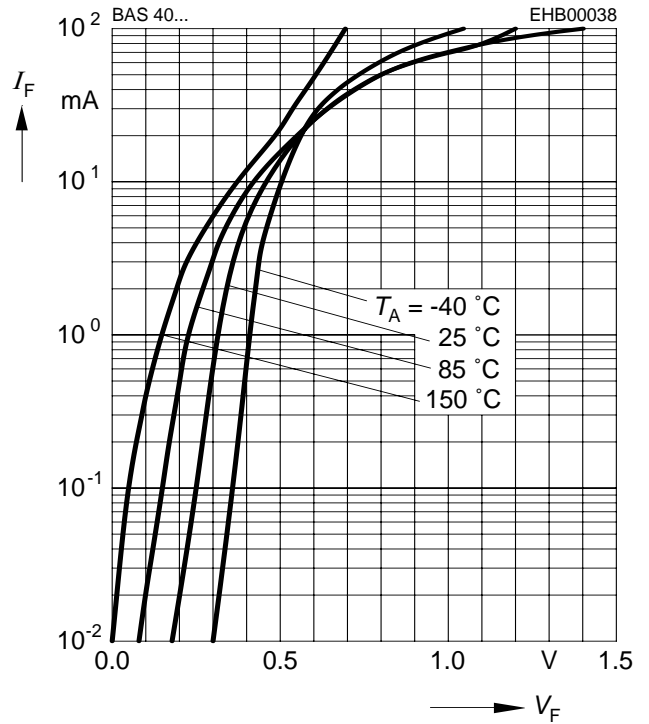

Forward current $I_F = f(T_S)$

BAS140W

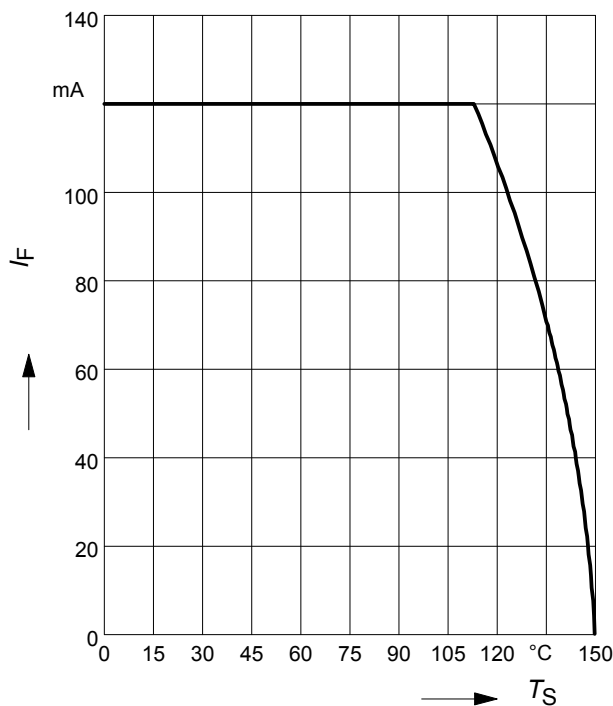

Forward current $I_F = f(T_S)$

BAS40, BAS40-07

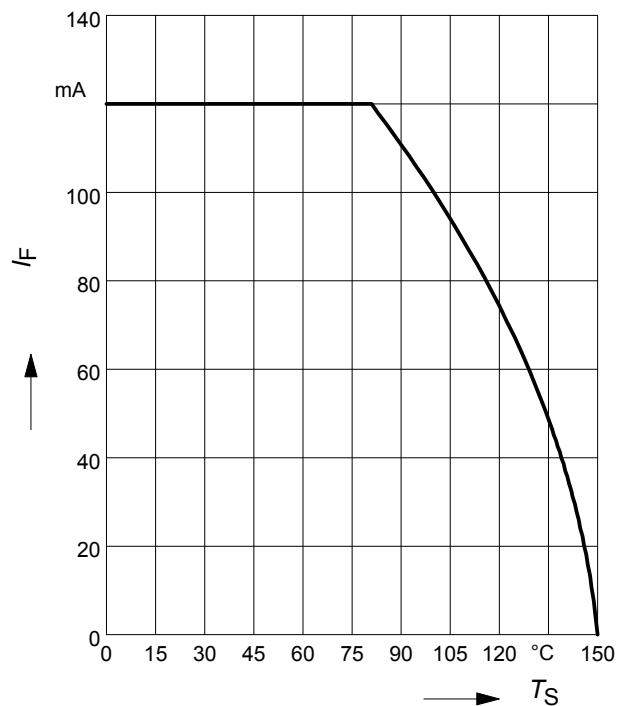

Forward current $I_F = f(T_S)$

BAS40-02L

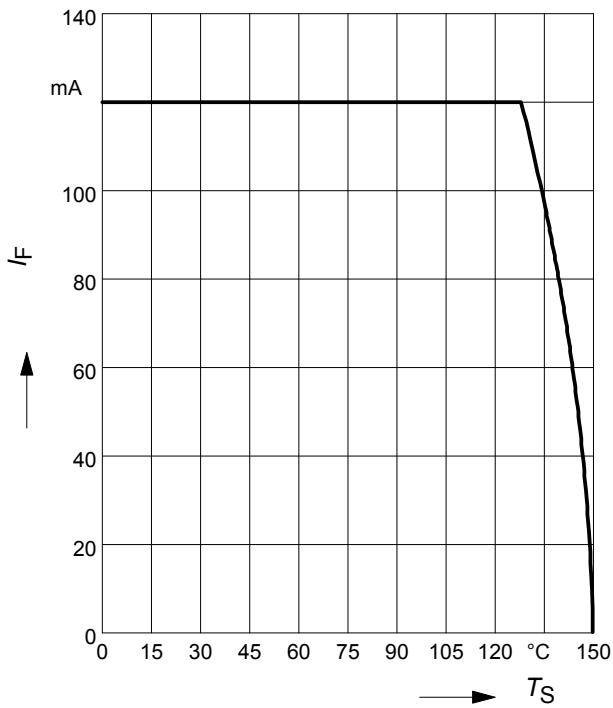

Forward current $I_F = f(T_S)$

BAS40-04, BAS40-06

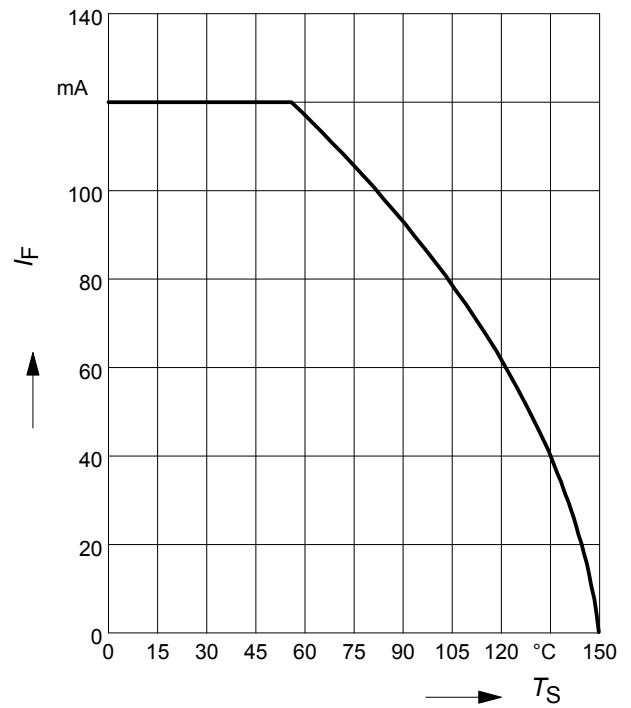

Forward current $I_F = f(T_S)$

BAS40-06W



Forward current $I_F = f(T_S)$

BAS40-05

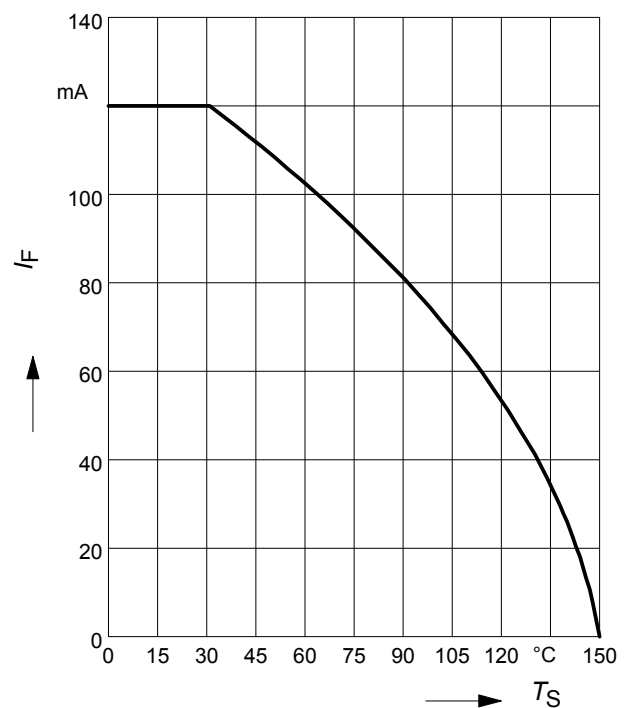

Forward current $I_F = f(T_S)$

BAS40-05W

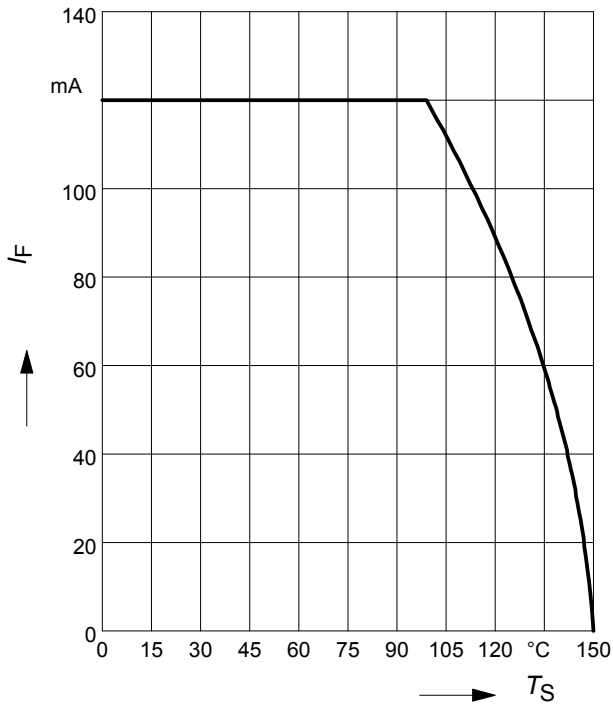

Forward current $I_F = f(T_S)$

BAS40-07W

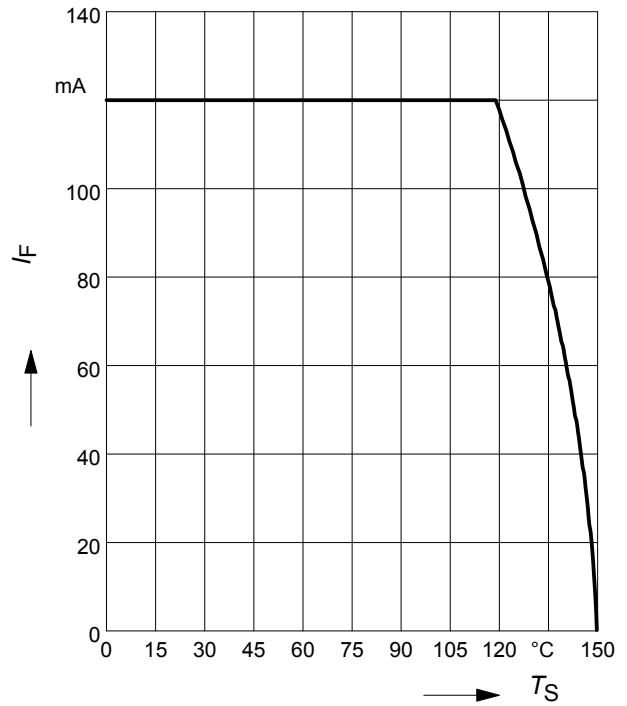

Permissible Puls Load $R_{thJS} = f(t_p)$

BAS140W

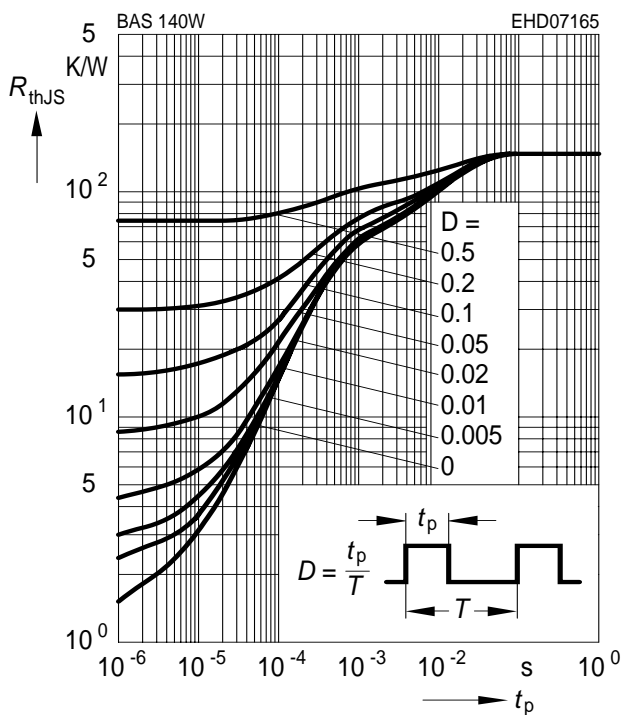

Permissible Pulse Load

$I_{Fmax} / I_{FDC} = f(t_p)$

BAS140W

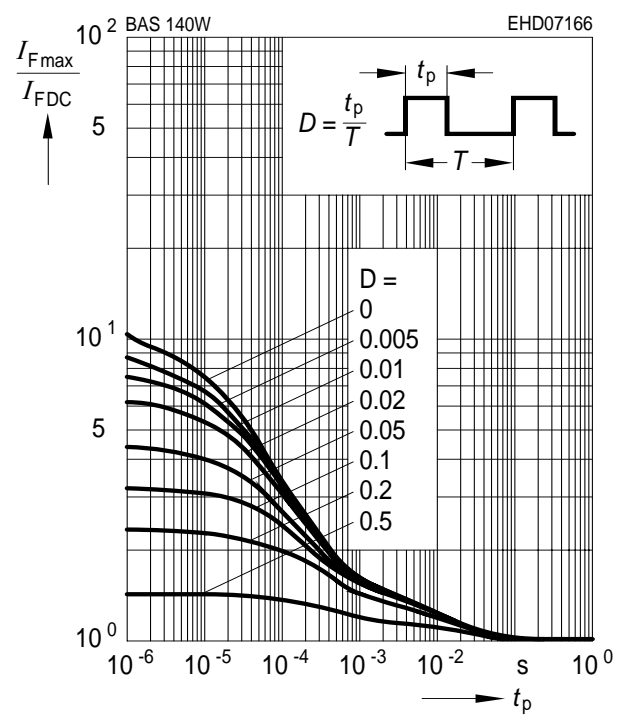

Permissible Puls Load $R_{thJS} = f(t_p)$

BAS40-02L

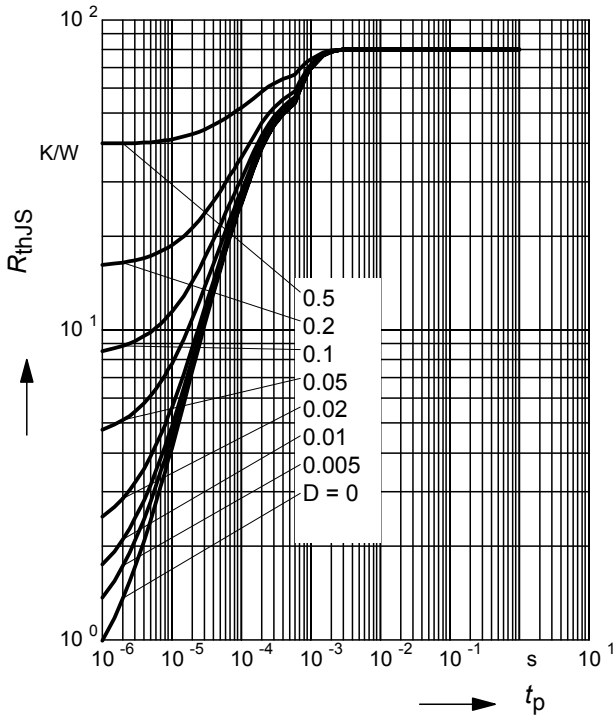

Permissible Pulse Load

$I_{Fmax} / I_{FDC} = f(t_p)$

BAS40-02L

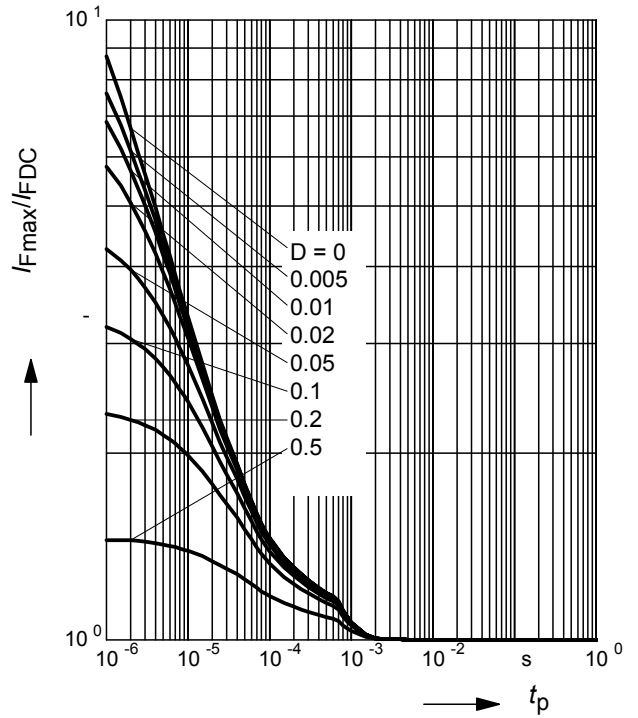

Permissible Puls Load $R_{thJS} = f(t_p)$

BAS40-06W



Permissible Pulse Load

$I_{Fmax} / I_{FDC} = f(t_p)$

BAS40-06W

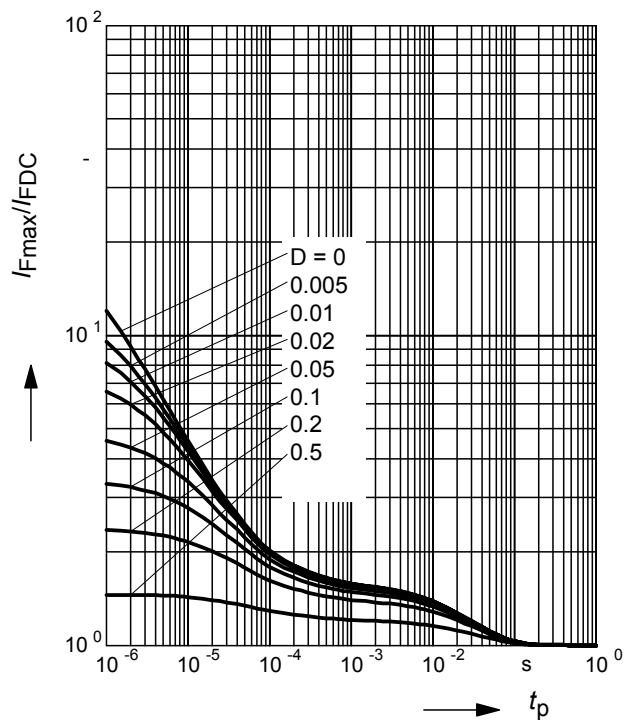

Permissible Puls Load $R_{thJS} = f(t_p)$

BAS40-05W

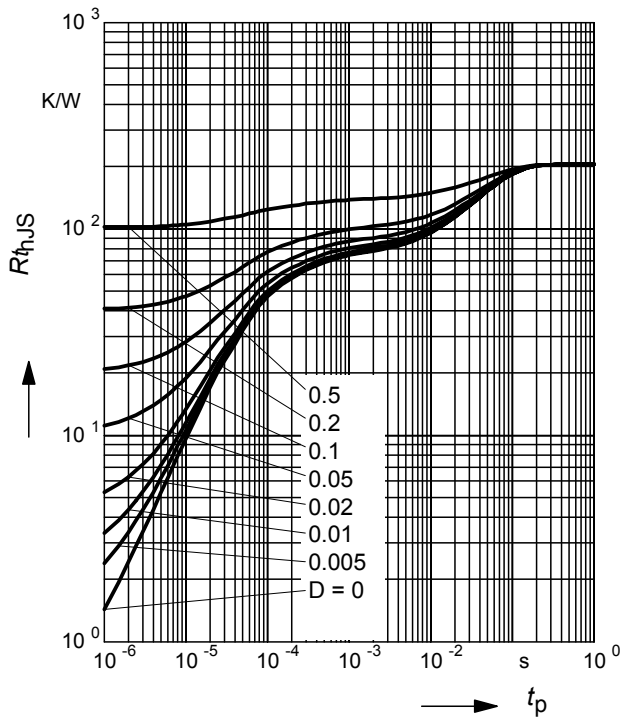

Permissible Pulse Load

$I_{Fmax} / I_{FDC} = f(t_p)$

BAS40-05W

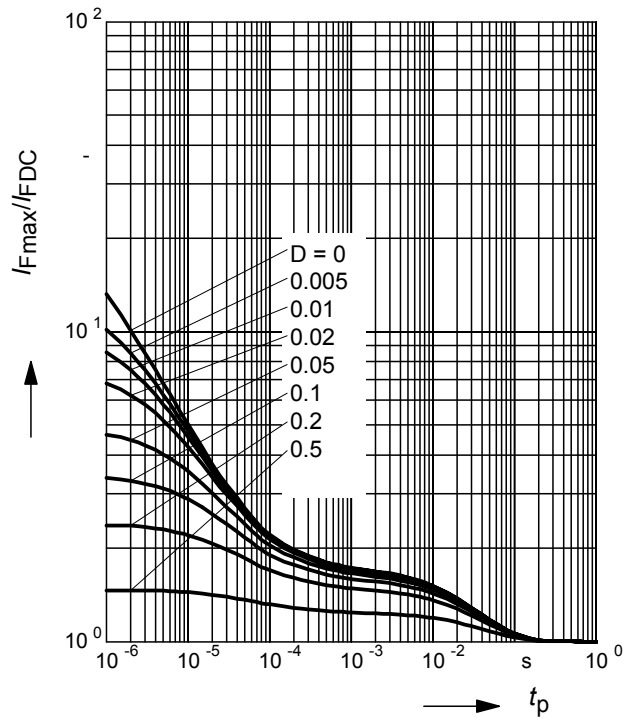

Package Outline



Foot Print

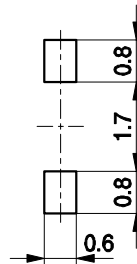

Marking Layout (Example)



Standard Packing

Reel ø180 mm = 3.000 Pieces/Reel
 Reel ø330 mm = 10.000 Pieces/Reel



Package Outline

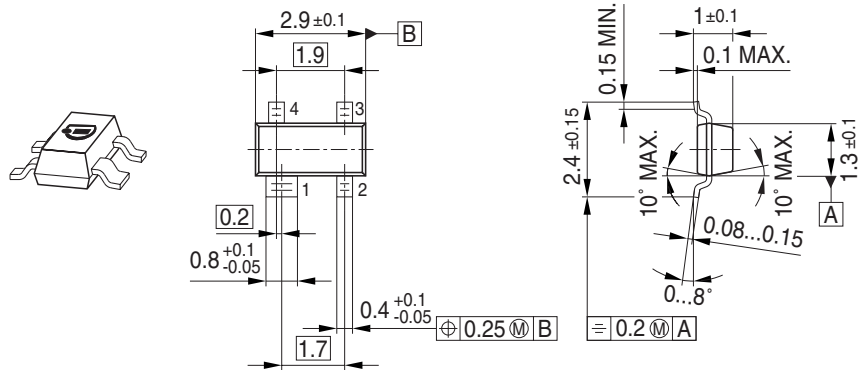

Foot Print

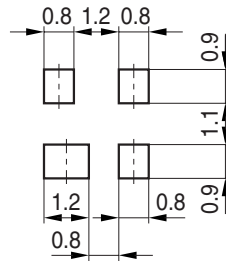

Marking Layout (Example)

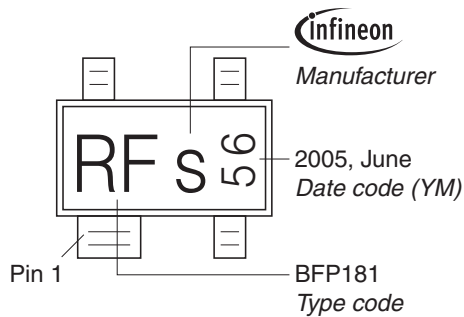

Standard Packing

Reel $\phi 180$ mm = 3.000 Pieces/Reel
 Reel $\phi 330$ mm = 10.000 Pieces/Reel

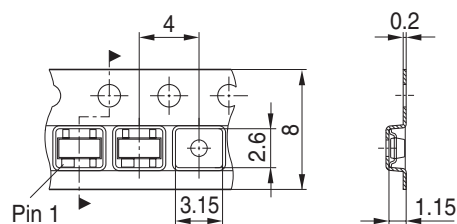

Package Outline



1) Lead width can be 0.6 max. in dambar area

Foot Print



Marking Layout (Example)



Standard Packing

Reel \varnothing 180 mm = 3.000 Pieces/Reel
 Reel \varnothing 330 mm = 10.000 Pieces/Reel



Package Outline



Foot Print



Marking Layout (Example)



Standard Packing

Reel ø180 mm = 3.000 Pieces/Reel
 Reel ø330 mm = 10.000 Pieces/Reel



Package Outline

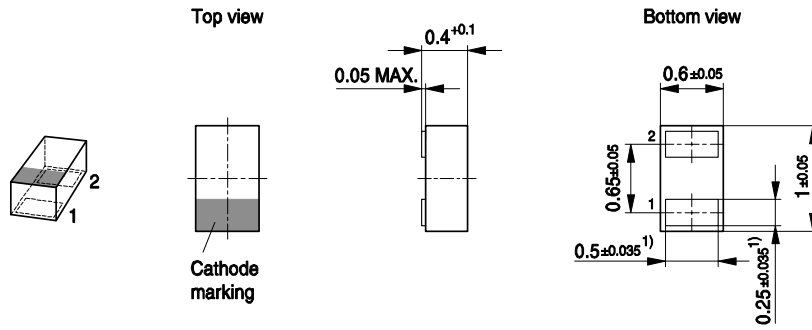

1) Dimension applies to plated terminal

Foot Print

For board assembly information please refer to Infineon website "Packages"

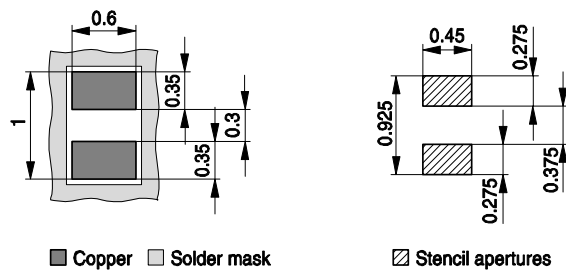

Marking Layout (Example)

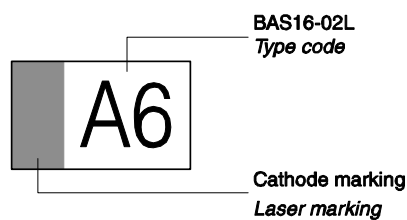

Standard Packing

Reel \varnothing 180 mm = 15.000 Pieces/Reel
 Reel \varnothing 330 mm = 50.000 Pieces/Reel (optional)

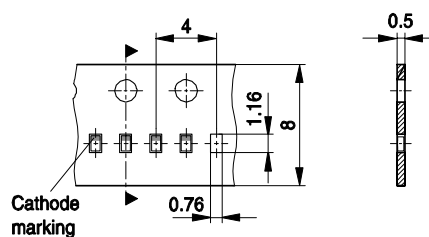

Edition 2009-11-16

**Published by
Infineon Technologies AG
81726 Munich, Germany**

**© 2009 Infineon Technologies AG
All Rights Reserved.**

Legal Disclaimer

The information given in this document shall in no event be regarded as a guarantee of conditions or characteristics. With respect to any examples or hints given herein, any typical values stated herein and/or any information regarding the application of the device, Infineon Technologies hereby disclaims any and all warranties and liabilities of any kind, including without limitation, warranties of non-infringement of intellectual property rights of any third party.

Information

For further information on technology, delivery terms and conditions and prices, please contact the nearest Infineon Technologies Office ([<www.infineon.com>](http://www.infineon.com)).

Warnings

Due to technical requirements, components may contain dangerous substances. For information on the types in question, please contact the nearest Infineon Technologies Office.

Infineon Technologies components may be used in life-support devices or systems only with the express written approval of Infineon Technologies, if a failure of such components can reasonably be expected to cause the failure of that life-support device or system or to affect the safety or effectiveness of that device or system. Life support devices or systems are intended to be implanted in the human body or to support and/or maintain and sustain and/or protect human life. If they fail, it is reasonable to assume that the health of the user or other persons may be endangered.

Mouser Electronics

Authorized Distributor

Click to View Pricing, Inventory, Delivery & Lifecycle Information:

[Infineon:](#)

[BAS140WE6327HTSA1](#) [BAS4007E6327HTSA1](#) [BAS4002LE6327XTMA1](#) [BAS4005WH6327XTSA1](#)
[BAS4006E6327HTSA1](#) [BAS4004E6327HTSA1](#) [BAS40E6327HTSA1](#) [BAS4005E6327HTSA1](#)