

THIS DRAWING IS UNPUBLISHED. RELEASED FOR PUBLICATION
 © COPYRIGHT - By - ALL RIGHTS RESERVED.

LOC		DIST		REVISIONS			
P	LTR	DESCRIPTION		DATE	DWN	APVD	
GP	00	W2	REVISED PER ECO-11-004835	11MAR11	RK	HMR	

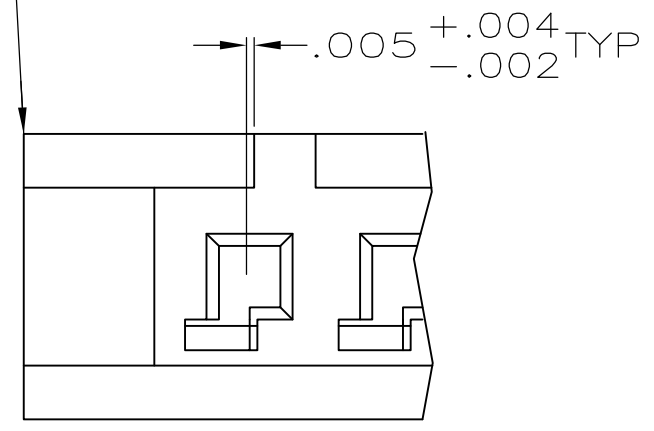
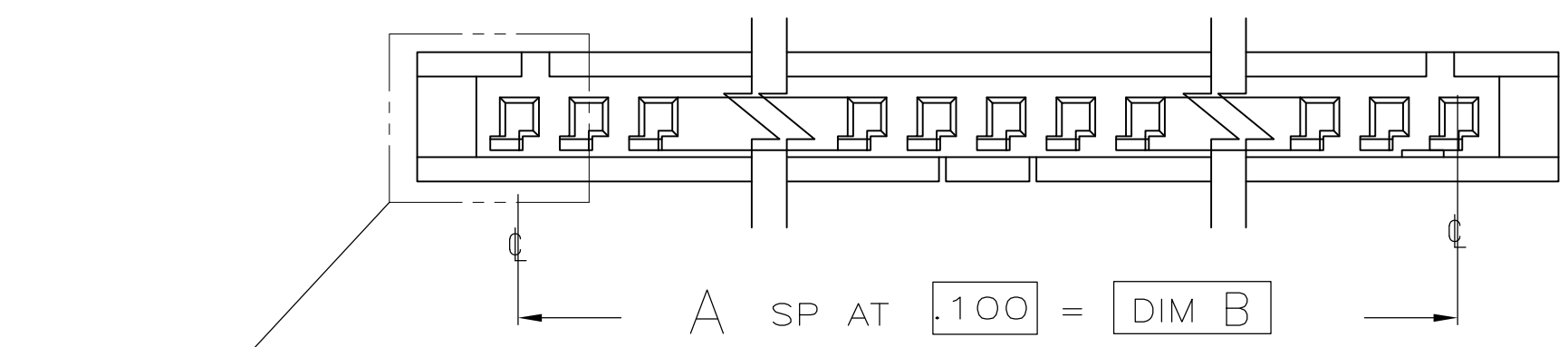
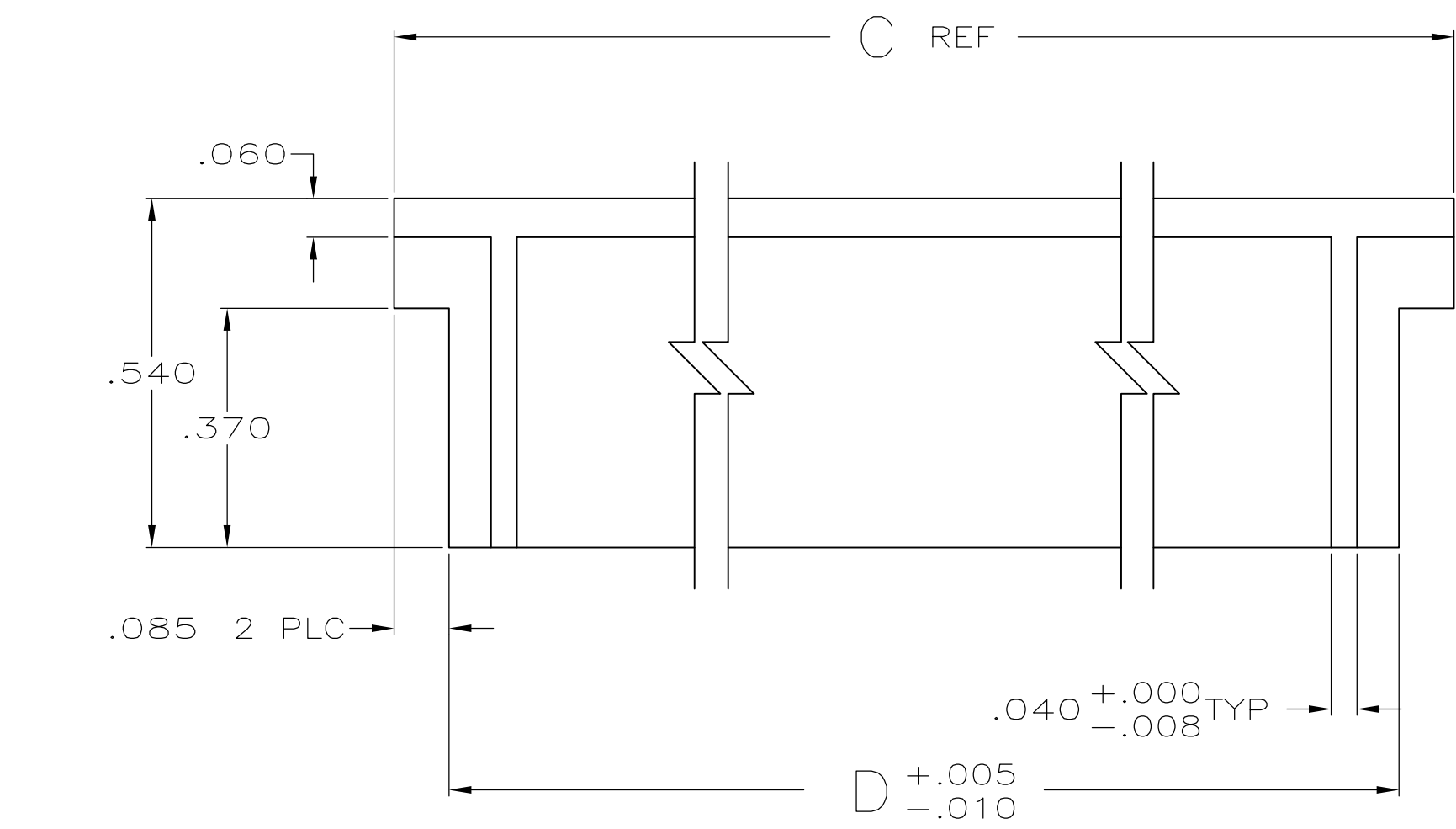
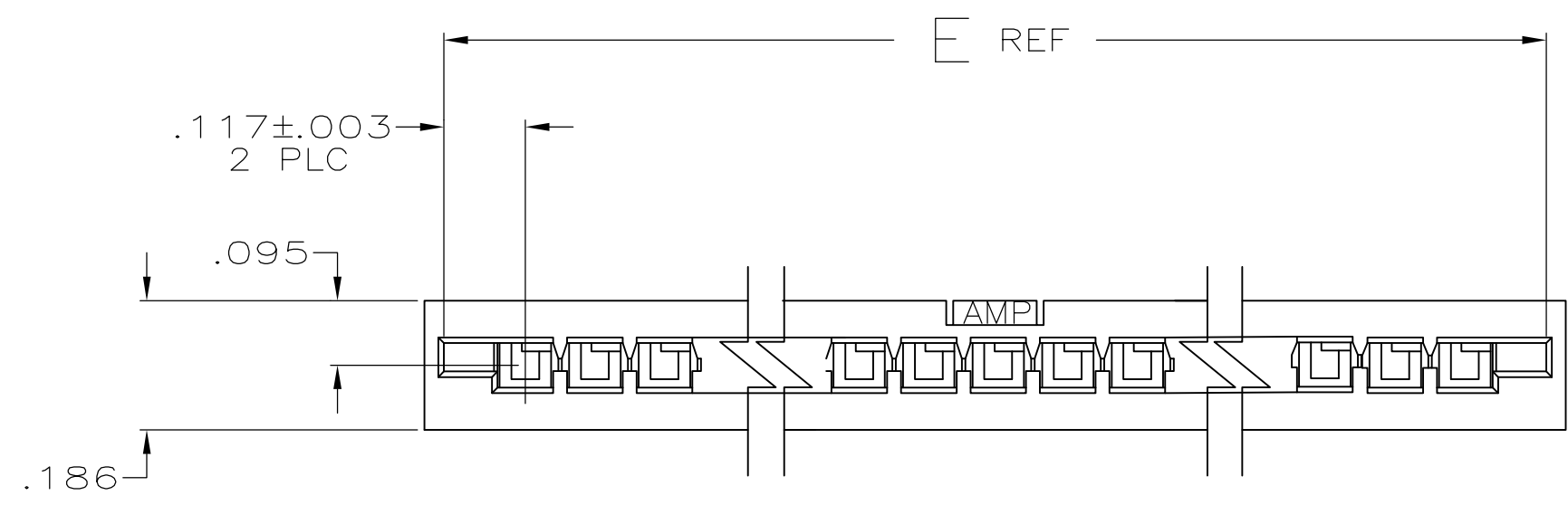

SCALE 8:1

- 1 GLASS-FILLED PBT, BLACK, UL V-0.
- 2 OBSOLETE PARTS: OBSOLETE CIS STREAMLINING PER D.RENAUD/D.SINISI

	3.634	3.520	3.690	3.400	34	35	3-88859-3
OBSOLETE	3.534	3.420	3.590	3.300	33	34	3-88859-2
OBSOLETE	3.434	3.320	3.490	3.200	32	33	3-88859-1
	3.334	3.220	3.390	3.100	31	32	3-88859-0
OBSOLETE	3.234	3.120	3.290	3.000	30	31	2-88859-9
OBSOLETE	3.134	3.020	3.190	2.900	29	30	2-88859-8
	3.034	2.920	3.090	2.800	28	29	2-88859-7
OBSOLETE	2.934	2.820	2.990	2.700	27	28	2-88859-6
OBSOLETE	2.834	2.720	2.890	2.600	26	27	2-88859-5
OBSOLETE	2.734	2.620	2.790	2.500	25	26	2-88859-4
OBSOLETE	2.634	2.520	2.690	2.400	24	25	2-88859-3
OBSOLETE	2.534	2.420	2.590	2.300	23	24	2-88859-2
OBSOLETE	2.434	2.320	2.490	2.200	22	23	2-88859-1
OBSOLETE	2.334	2.220	2.390	2.100	21	22	2-88859-0
OBSOLETE	2.234	2.120	2.290	2.000	20	21	1-88859-9
OBSOLETE	2.034	1.920	2.090	1.800	18	19	1-88859-8
OBSOLETE	1.934	1.820	1.990	1.700	17	18	1-88859-7
OBSOLETE	1.834	1.720	1.890	1.600	16	17	1-88859-6
	1.734	1.620	1.790	1.500	15	16	1-88859-5
	1.234	1.120	1.290	1.000	10	11	1-88859-4
	1.034	.920	1.090	.800	8	9	1-88859-3
	.834	.720	.890	.600	6	7	1-88859-2
	.634	.520	.690	.400	4	5	1-88859-1
	.534	.420	.590	.300	3	4	1-88859-0
	.434	.320	.490	.200	2	3	88859-9
	2.134	2.020	2.190	1.900	19	20	88859-8
	1.534	1.420	1.590	1.300	13	14	88859-7
	1.634	1.520	1.690	1.400	14	15	88859-6
	1.434	1.320	1.490	1.200	12	13	88859-5
	1.334	1.220	1.390	1.100	11	12	88859-4
	1.134	1.020	1.190	.900	9	10	88859-3
	.934	.820	.990	.700	7	8	88859-2
	.734	.620	.790	.500	5	6	88859-1
E	D	C	B	A	NO OF POSN	PART NUMBER	

THIS DRAWING IS A CONTROLLED DOCUMENT.

DWN	H MOLL	6-8-88
CHK	G.D. MILLER	8-4-88
APVD	-	-
PRODUCT SPEC	-	-
APPLICATION SPEC	-	-
WEIGHT	-	-
CUSTOMER DRAWING	SCALE 4:1	SHEET 1 of 1

TE Connectivity
 HOUSING, RECEPTACLE, FFC, .100 CL

SIZE A2 CAGE CODE 00779 DRAWING NO C-88859 RESTRICTED TO -

SCALE 4:1 SHEET 1 of 1 REV W2

Mouser Electronics

Authorized Distributor

Click to View Pricing, Inventory, Delivery & Lifecycle Information:

[TE Connectivity:](#)

[88859-9](#)