

MATERIALS AND FINISHES:

BODY, TUBE, CRIMP TUBE, JAMNUT BRASS
PLATED NICKEL

CENTER CONTACT BERYLLIUM COPPER
PLATED GOLD

INSULATOR, SLEEVE TEFLON

LOCKWASHER PHOSPHOR BRONZE
PLATED NICKEL

GASKET SILICONE RUBBER

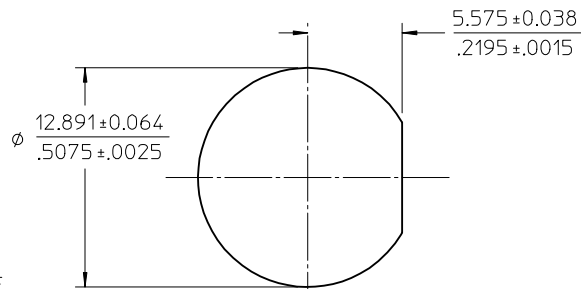
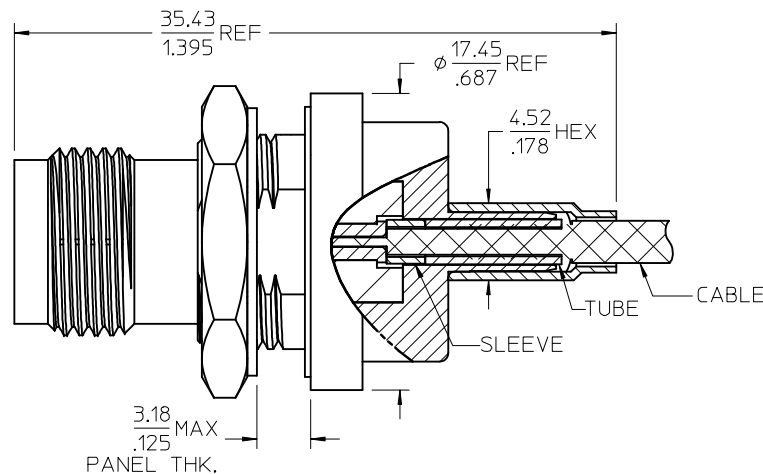

RECOMMENDED PANEL CUTOUT

TNC JACK
INTERFACE

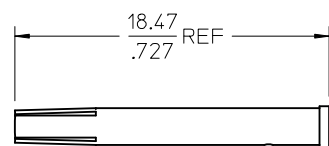
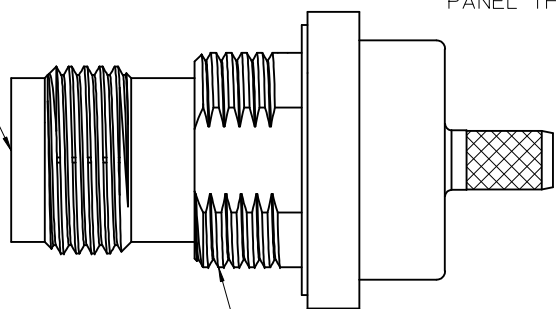

CONTACT

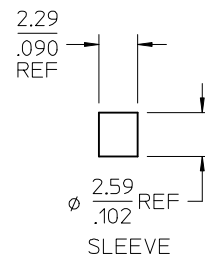

SLEEVE

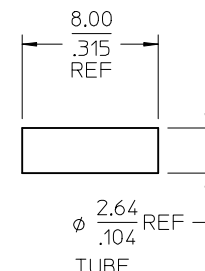

TUBE

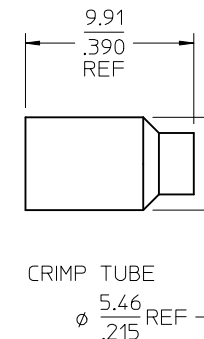

CRIMP TUBE

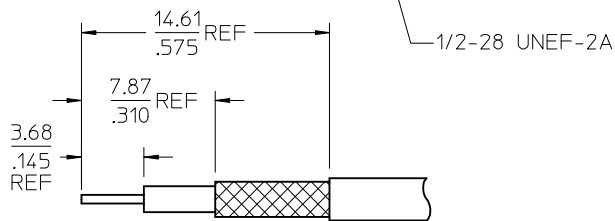

RECOMMENDED STRIPPING DIMENSION

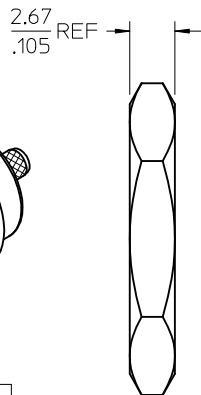
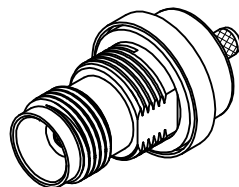

JAMNUT

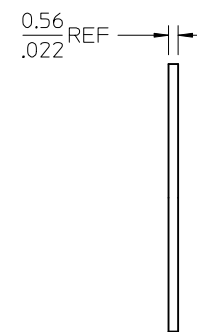

LOCKWASHER

MIL-STD-348A, FIG. 313.2	INTERFACE
SPECIFICATION	DESCRIPTION

73216-1331	ONE PER BAG
73216-1330	BULK
PART NO.	PACKAGING

CHG: UPDATE STRIP
EC NO: URF2013-0644
DRWN: WIENER 2013/05/16
CHKD: SSS 2013/05/16
APPR: WIENER 2013/05/21

QUALITY SYMBOLS
▽=0
▽=0

GENERAL TOLERANCES (UNLESS SPECIFIED)

	mm	INCH
4 PLACES	± .005	± .0002
3 PLACES	± .005	± .0002
2 PLACES	± .005	± .0002
1 PLACE	± .005	± .0002

ANGULAR ± 2 °

DRAFT WHERE APPLICABLE MUST REMAIN WITHIN DIMENSIONS

DIMENSION STYLE MM/IN

DRAWN BY	DATE
SSS	2004/03/17
CHECKED BY	DATE
TEF	2004/03/17
APPROVED BY	DATE
GMH	2004/03/17

MATERIAL NO. SEE TABLE
DOCUMENT NO. SD-73216-133

SCALE DESIGN UNITS METRIC

THIRD ANGLE PROJECTION

TNC JACK, BLKHD, RG316
50 OHMS, EWR-2370
TNC-JC/BLKD

MOLEX INCORPORATED

SHEET NO. 1 OF 1

THIS DRAWING CONTAINS INFORMATION THAT IS PROPRIETARY TO MOLEX INCORPORATED AND SHOULD NOT BE USED WITHOUT WRITTEN PERMISSION

Mouser Electronics

Authorized Distributor

Click to View Pricing, Inventory, Delivery & Lifecycle Information:

[Molex:](#)

[73216-1331](#)