

THIS DRAWING IS UNPUBLISHED. RELEASED FOR PUBLICATION. ALL RIGHTS RESERVED.

LOC		DIST		REVISIONS				
P	LTR	DESCRIPTION			DATE	DWN	APVD	
-	-	A	INITIAL RELEASE			08AUG2014	PS	JK

REFERENCE MATING INTERFACE PATTERN:  
1,27 STAGGERED PITCH x 1,5 ROW-DISTANCE.

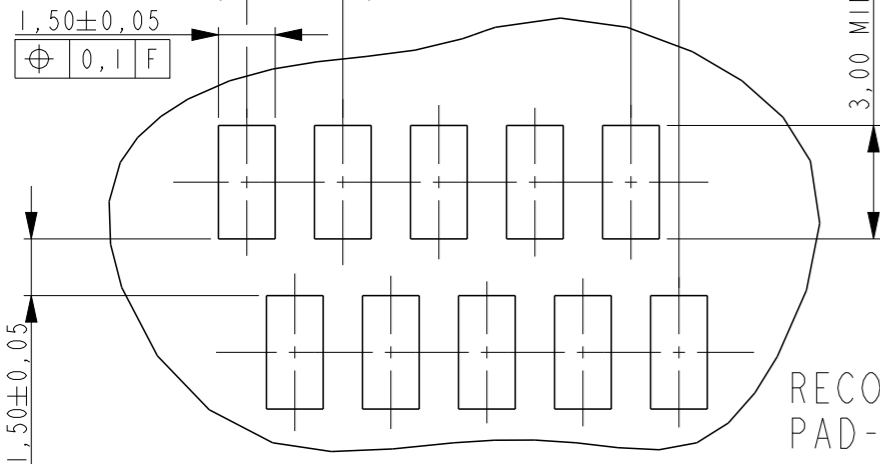
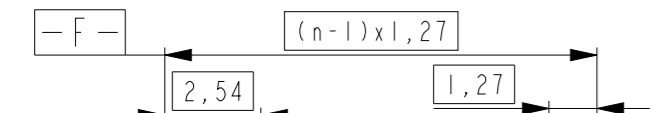
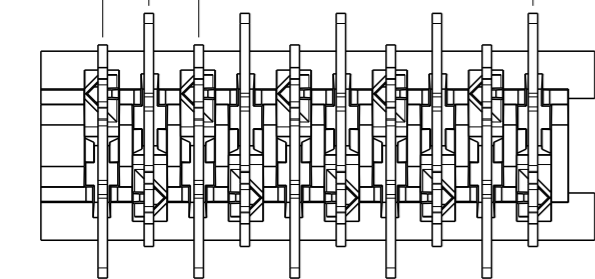
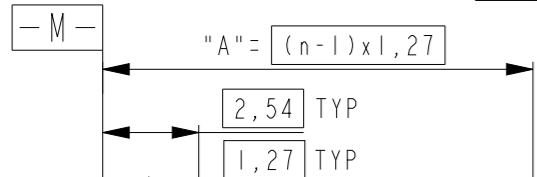
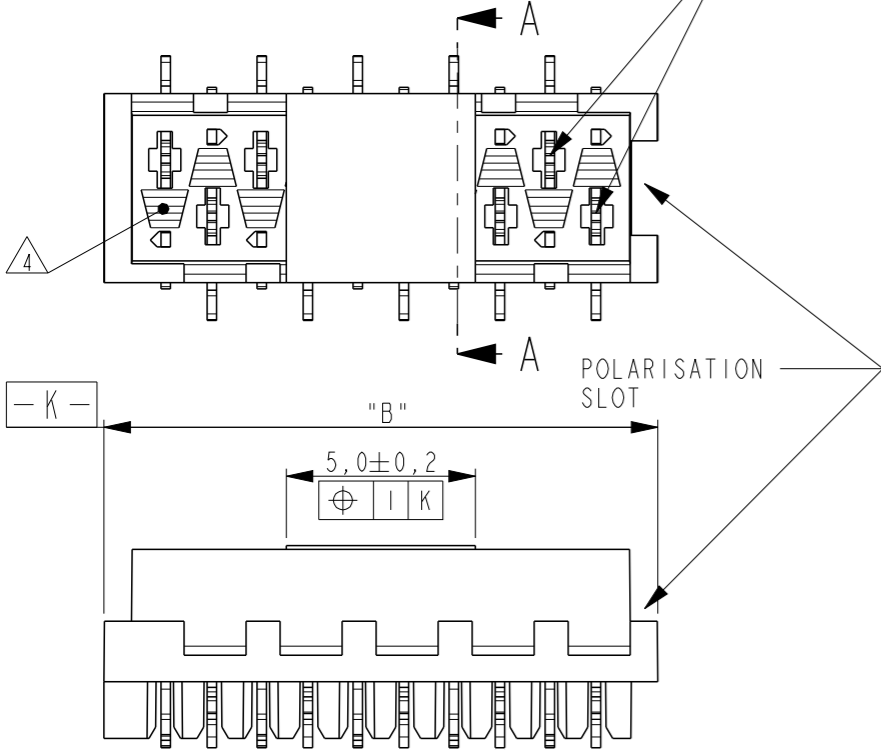

RECOMMENDED PC-BOARD  
PAD-LAYOUT TOP VIEW

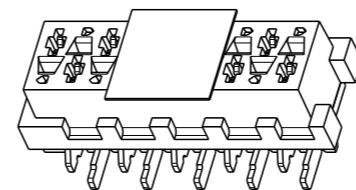
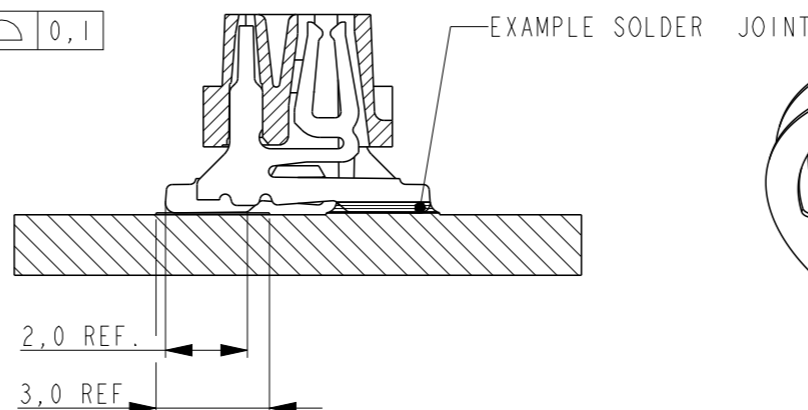
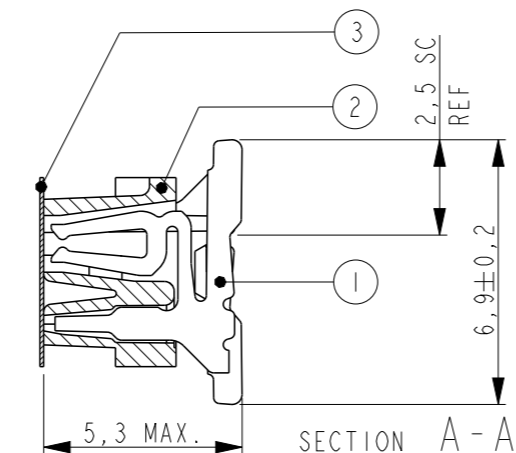

SCALE 3:1

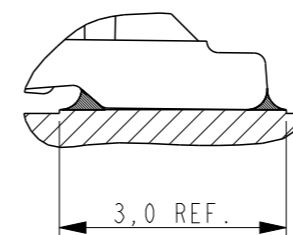

SOLDER DETAIL  
SCALE 10:1

1	PARTNUMBER VAC. TAPE.	3	PARTNUMBER	NO. OF POS. "n"	"A"	"B" MAX.
	7-2178711-4		2178711-4	4	3,81	7,1
	7-2178711-6		2178711-6	6	6,35	9,7
	7-2178711-8		2178711-8	8	8,89	12,2
	8-2178711-0		1-2178711-0	10	11,43	14,7
	8-2178711-2		1-2178711-2	12	13,97	17,3
	8-2178711-4		1-2178711-4	14	16,51	19,8
	8-2178711-6		1-2178711-6	16	19,05	22,4
	8-2178711-8		1-2178711-8	18	21,59	24,9
	9-2178711-0		2-2178711-0	20	24,13	27,5

NOTES:

- 1 TAPE FOR VACUUM P&P ONLY FOR DASHNUMBERS 7- /8- /9-
- 2 FOR PACKAGING SEE SHEET 2 OF 2
- 3 WITHOUT VACUUM TAPE.
- 4 CORING-OUTS FOR MANUFACTURING PURPOSE ONLY.  
SHAPE MAY VARY, BUT IS NOT FUNCTIONAL FOR THE APPLICATION.
- 5 SHOWN IS A 10 POSITION CONNECTOR.

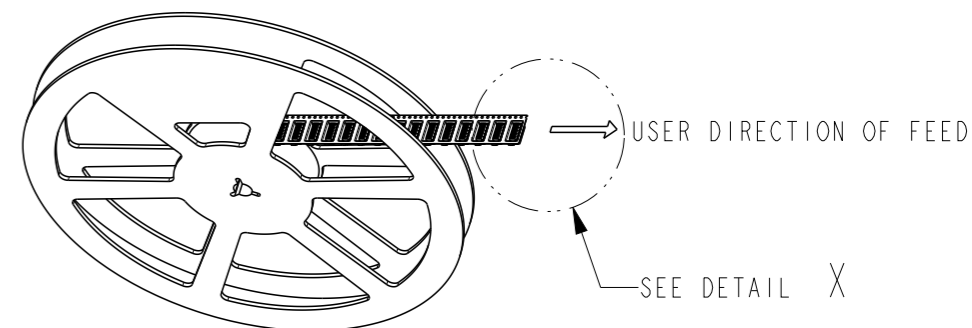

ACCORDING EIA-481/DIN IEC 286

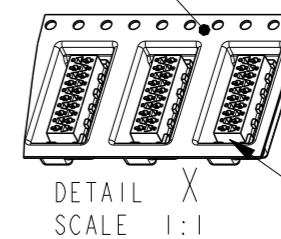

DETAIL X  
SCALE 1:1  
POLARIZATION-SLOT  
ON THIS SIDE.

ITEM NO.	COMPONENT DESCRIPTION	MATERIAL	FINISH / COLOR
3	PICK & PLACE TAPE	KAPTON	AMBER TRANSPARENT
2	FEMALE HOUSING	POLYAMIDE 4/6,GF	BLACK
1	FEMALE CONTACT	TIN BRASS	3.0 - 5.0µm TIN OVER 0.5µm NICKEL

THIS DRAWING IS A CONTROLLED DOCUMENT.		DWN 30JUL2014 PRASHANTH	TE Connectivity Micro-MaTch VALUE LINE FEMALE-ON-BOARD, TOP ENTRY, SMD, CONNECTOR		
DIMENSIONS: mm		CHK 05AUG2014 PRASHANTH			NAME
TOLERANCES UNLESS OTHERWISE SPECIFIED:		APVD 05AUG2014 JAYANTH KUMAR			PRODUCT SPEC
0 PLC ±- 1 PLC ±- 2 PLC ±- 3 PLC ±- 4 PLC ±- ANGLES ±- FINISH ±-		APPLICATION SPEC			SIZE
MATERIAL	SEE TABLE	WEIGHT	114-13318	A3	
CUSTOMER DRAWING		SCALE 5:1		SHEET 1 OF 2	

THIS DRAWING IS UNPUBLISHED.

RELEASED FOR PUBLICATION

© COPYRIGHT -

ALL RIGHTS RESERVED.

LOC - DIST -

REVISIONS

P LTR

DESCRIPTION

DATE

DWN

APVD

SEE SHEET 1

TAPE WIDTH 24 mm

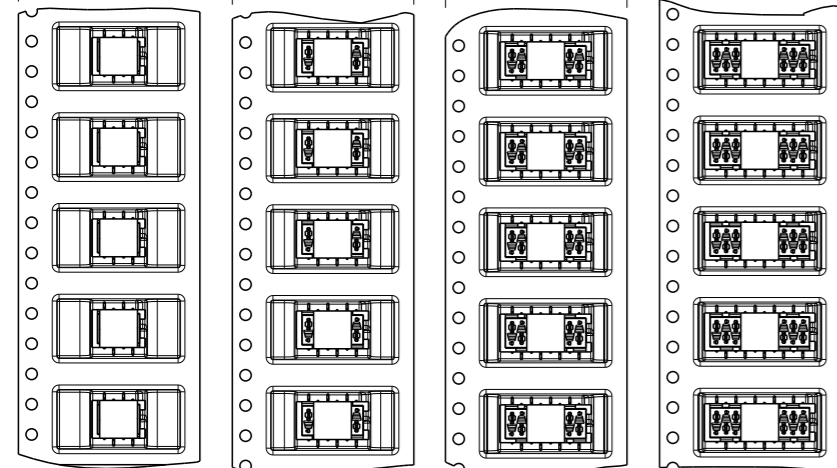

7-2178711-4 4 POSITION 2178711-4  
7-2178711-6 6 POSITION 2178711-6  
7-2178711-8 8 POSITION 2178711-8  
8-2178711-0 10 POSITION 1-2178711-0

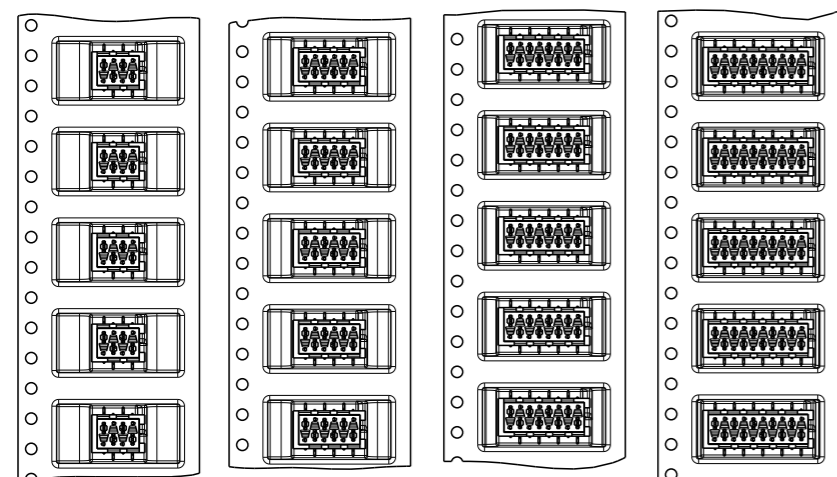

TAPE WIDTH 44 mm

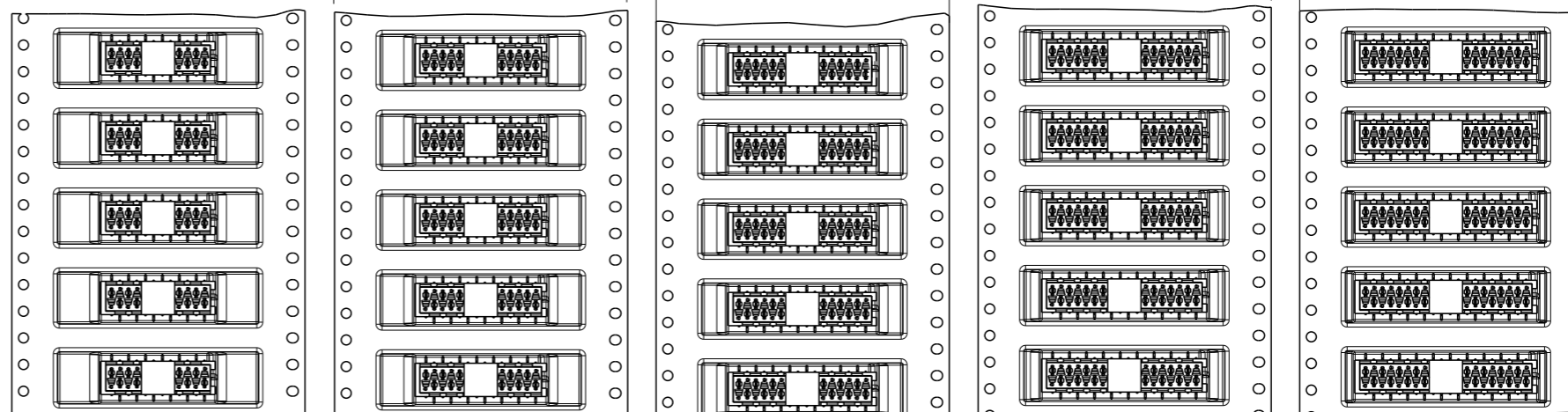

8-2178711-2 12 POSITION 1-2178711-2  
8-2178711-4 14 POSITION 1-2178711-4  
8-2178711-6 16 POSITION 1-2178711-6  
8-2178711-8 18 POSITION 1-2178711-8  
9-2178711-0 20 POSITION 2-2178711-0

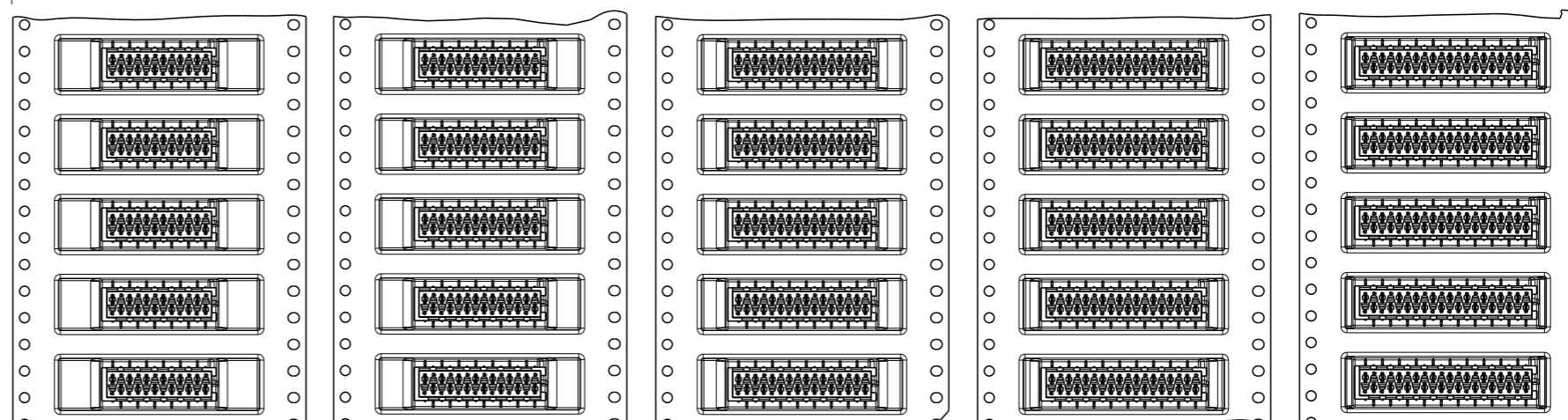

THIS DRAWING IS A CONTROLLED DOCUMENT.

DIMENSIONS: mm

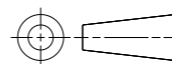

TOLERANCES UNLESS OTHERWISE SPECIFIED:

- 0 PLC ±-
1 PLC ±0.1
2 PLC ±0.05
3 PLC ±-
4 PLC ±-
ANGLES ±-
FINISH -

MATERIAL -

DWN 25JUL2014 PRASHANTH

CHK 05AUG2014 PRASHANTH

APVD 05AUG2014 JAYANTH KUMAR

PRODUCT SPEC 108-32087

APPLICATION SPEC 114-13318

WEIGHT -

CUSTOMER DRAWING



Micro-MaTch VALUE LINE FEMALE-ON-BOARD, TOP ENTRY, SMD, CONNECTOR

SIZE CAGE CODE DRAWING NO RESTRICTED TO

A3 00779 C-2178711

SCALE 1:1 SHEET 2 OF 2 REV A

# Mouser Electronics

Authorized Distributor

Click to View Pricing, Inventory, Delivery & Lifecycle Information:

[TE Connectivity:](#)

[2178711-4](#)