

PRODUCT NUMBER	PLATING PERFORMANCE LEVEL	APPLICATION	SHROUD TO USE FOR REAR PLUG-UP APPLICATIONS
74978-102ZZZ	TELCORDIA CO	STANDARD	84625-102
74978-102ZZZLF		LEAD FREE	84625-302
74978-502ZZZ	TELCORDIA UE	STANDARD	84625-302
74978-502ZZZLF		LEAD FREE	84625-502

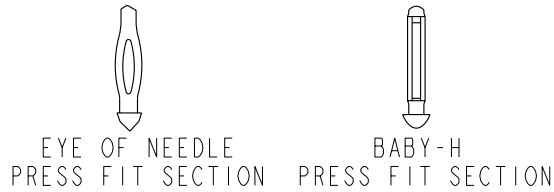

DETAIL A  
SCALE 4:1  
SEE NOTE 15

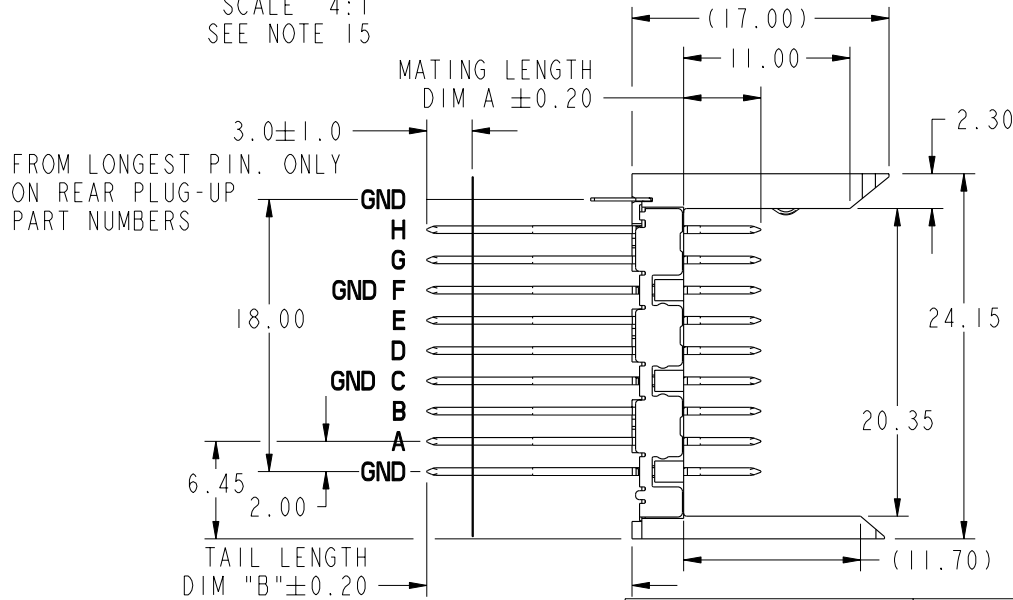

SEE DETAIL A

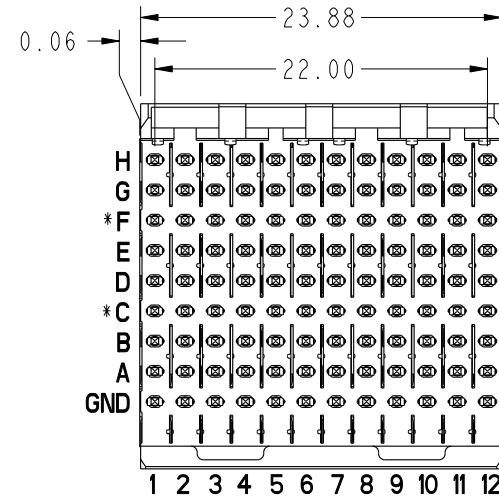
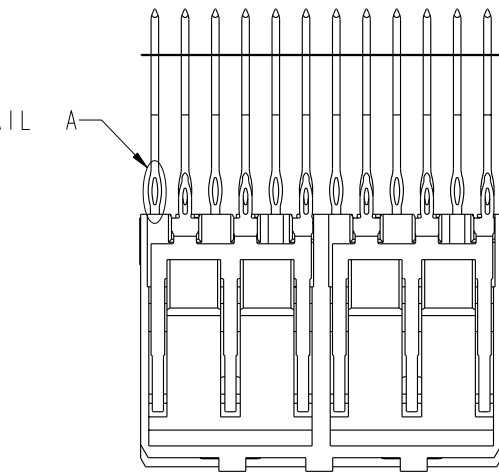

mat'l code SEE NOTE 5				tolerances unless otherwise specified			CUSTOMER	FCI	
ltr	ecm no.	dr	date	linear	0.X $\pm 0.3$	COPY	www.fciconnect.com		
P	V06-0544	DCH	2006-06-09		0.XX $\pm 0.13$	projection	title VERTICAL SIGNAL HDR 8 ROW		
R	V07-0183	DCH	2007-04-20		.XXX $\pm 0.051$		P.F. 96 POS. SPECIAL LOAD EXT.		
S	V08-0010	HTB	2008-01-07	angles	0° $\pm 2°$		product family METRAL 2000 code		
T	V08-0023	LP	2008-1-23	dr	E. KROPER. 2001-01-10	MM	size	dwg no	213
-	-	-	-	enrg	J. VOLSTORF 2001-01-10		scale	A	74978
M	V03-1156	TAB	2003-11-03	chr	J. VOLSTORF 2001-01-10	1:1	cage code		
N	V05-0814	VS	2005-09-21	appd	J. VOLSTORF 2001-01-10		22526		
sheet index	revision sheet	T	T	T	T	T	T	T	T
		1	2	3	4	5	6		

**\*ROW C AND F INFORMATION**  
ODD NUMBER COLUMNS WITHIN ROW C & F ARE COMMONED TO GROUND INTERNALLY WITHIN THE HOUSING. THE EVEN NUMBER COLUMNS WITHIN ROW C & F ARE NOT. FOR MAXIMUM PERFORMANCE IT IS RECOMMENDED THESE EVEN COLUMNS BE GROUND COMMONED WITHIN PCB. SEE NOTE 14

This document is the property of and embodies CONFIDENTIAL and PROPRIETARY information of FCI. No part of the information shown on this document may be used in any way or disclosed to others without the written consent of FCI. Copyright FCI.

PIN CODE NO.	DIM A MATING LENGTH	DIM B TAIL LENGTH	PCB THICKNESS RANGE ACCOMMODATED BY PIN'S TAIL LENGTH				
			WHEN MATING TO A 74981 METRAL 1000 SERIES RECEPTACLE		WHEN MATING TO A 52066 SERIES METRAL 4000 RECEPTACLE		
			ROWS A,B,C, D,E,F,G & H	GROUND ROW	ROWS:A,B, D,E,G & H	ROW C&F	GROUND ROW
01*	5.00	4.30	1.60 MIN	1.60 MIN	1.60 MIN	1.60 MIN	1.60 MIN
22		12.20	2.95 - 3.80	2.95 - 4.20	2.95 - 3.80	2.95 - 3.80	2.95 - 4.20
30		12.95	2.95 - 4.55	3.25 - 4.95	2.95 - 4.55	2.95 - 4.55	3.25 - 4.95
05		13.70	2.95 - 5.30	4.00 - 5.70	3.30 - 5.30	2.95 - 5.30	4.00 - 5.70
35		14.45	3.05 - 6.05	4.75 - 6.45	4.05 - 6.05	3.05 - 6.05	4.75 - 6.45
48		15.20	3.80 - 6.80	5.50 - 7.20	4.80 - 6.80	3.80 - 6.80	5.50 - 7.20
40		15.70	4.30 - 7.30	6.00 - 7.70	5.30 - 7.30	4.30 - 7.30	6.00 - 7.70
65		16.40	5.00 - 8.00	6.70 - 8.40	6.00 - 8.00	5.00 - 8.00	6.70 - 8.40
09		17.10	5.70 - 8.70	7.40 - 9.10	6.70 - 8.70	5.70 - 8.70	7.40 - 9.10
02*	5.75	4.30	1.60 MIN	1.60 MIN	1.60 MIN	1.60 MIN	1.60 MIN
44		12.20	2.95 - 3.80	2.95 - 4.20	2.95 - 3.80	2.95 - 3.80	2.95 - 4.20
31		12.95	2.95 - 4.55	3.25 - 4.95	2.95 - 4.55	2.95 - 4.55	3.25 - 4.95
06		13.70	2.95 - 5.30	4.00 - 5.70	3.30 - 5.30	2.95 - 5.30	4.00 - 5.70
36		14.45	3.05 - 6.05	4.75 - 6.45	4.05 - 6.05	3.05 - 6.05	4.75 - 6.45
49		15.20	3.80 - 6.80	5.50 - 7.20	4.80 - 6.80	3.80 - 6.80	5.50 - 7.20
25		15.70	4.30 - 7.30	6.00 - 7.70	5.30 - 7.30	4.30 - 7.30	6.00 - 7.70
66		16.40	5.00 - 8.00	6.70 - 8.40	6.00 - 8.00	5.00 - 8.00	6.70 - 8.40
10		17.10	5.70 - 8.70	7.40 - 9.10	6.70 - 8.70	5.70 - 8.70	7.40 - 9.10
03*	6.50	4.30	1.60 MIN	1.60 MIN	1.60 MIN	1.60 MIN	1.60 MIN
45		12.20	2.95 - 3.80	2.95 - 4.20	2.95 - 3.80	2.95 - 3.80	2.95 - 4.20
32		12.95	2.95 - 4.55	3.25 - 4.95	2.95 - 4.55	2.95 - 4.55	3.25 - 4.95
07		13.70	2.95 - 5.30	4.00 - 5.70	3.30 - 5.30	2.95 - 5.30	4.00 - 5.70
37		14.45	3.05 - 6.05	4.75 - 6.45	4.05 - 6.05	3.05 - 6.05	4.75 - 6.45
50		15.20	3.80 - 6.80	5.50 - 7.20	4.80 - 6.80	3.80 - 6.80	5.50 - 7.20
41		15.70	4.30 - 7.30	6.00 - 7.70	5.30 - 7.30	4.30 - 7.30	6.00 - 7.70
24		16.40	5.00 - 8.00	6.70 - 8.40	6.00 - 8.00	5.00 - 8.00	6.70 - 8.40
11		17.10	5.70 - 8.70	7.40 - 9.10	6.70 - 8.70	5.70 - 8.70	7.40 - 9.10



This document is the property of and embodies CONFIDENTIAL and PROPRIETARY information of FCI. No part of the information shown on this document may be used in any way or disclosed to others without the written consent of FCI. Copyright FCI.

\* STUB PINS - NO REAR PLUG-UP

\*\* THE GREATEST RANGE OCCURS WHEN THE B DIMENSION OF PIN 'GND' IS ONE SIZE SHORTER THEN THE OTHER PINS.

mat'l code SEE NOTE 5				tolerances unless otherwise specified		CUSTOMER	FCI www.fciconnect.com		
ltr	ecr no.	dr	date	linear	0.X ±0.3	projection	COPY		
T					0.XX ±0.13		title		
					.XXX ±.051		VERTICAL SIGNAL HDR 8 ROW		
				angles	0° ±2°		P.F. 96 POS. SPECIAL LOAD EXT.		
				dr	E. KROPER. 2001-01-10		MM	product family	METRAL 2000
				engr	J. VOLSTORF 2001-01-10			code	213
				chr	J. VOLSTORF 2001-01-10	size		dwg no	74978
				appd	J. VOLSTORF 2001-01-10	sheet		2	
sheet index	revision sheet					scale	1:1		

PIN CODE NO.	DIM A MATING LENGTH	DIM B TAIL LENGTH	PCB THICKNESS RANGE ACCOMMODATED BY PIN LENGTH				
			WHEN MATING TO A 73981 OR 84688 SERIES RECEPTACLE		WHEN MATING TO A 52057 SERIES METRAL 4000 RECEPTACLE		
			ROWS A,B,C,D,E	GROUND ROW	ROWS:A,B,D,E	ROW C	GROUND ROW
04*	7.25	4.30	1.60 MIN	1.60 MIN	1.60 MIN	1.60 MIN	1.60 MIN
46		12.20	2.95 - 3.80	2.95 - 4.20	2.95 - 3.80	2.95 - 3.80	2.95 - 4.20
33		12.95	2.95 - 4.55	3.25 - 4.95	2.95 - 4.55	2.95 - 4.55	3.25 - 4.95
08		13.70	2.95 - 5.30	4.00 - 5.70	3.30 - 5.30	2.95 - 5.30	4.00 - 5.70
38		14.45	3.05 - 6.05	4.75 - 6.45	4.05 - 6.05	3.05 - 6.05	4.75 - 6.45
51		15.20	3.80 - 6.80	5.50 - 7.20	4.80 - 6.80	3.80 - 6.80	5.50 - 7.20
42		15.70	4.30 - 7.30	6.00 - 7.70	5.30 - 7.30	4.30 - 7.30	6.00 - 7.70
67		16.40	5.00 - 8.00	6.70 - 8.40	6.00 - 8.00	5.00 - 8.00	6.70 - 8.40
12		17.10	5.70 - 8.70	7.40 - 9.10	6.70 - 8.70	5.70 - 8.70	7.40 - 9.10
19*	8.00	4.30	1.60 MIN	1.60 MIN	1.60 MIN	1.60 MIN	1.60 MIN
47		12.20	2.95 - 3.80	2.95 - 4.20	2.95 - 3.80	2.95 - 3.80	2.95 - 4.20
34		12.95	2.95 - 4.55	3.25 - 4.95	2.95 - 4.55	2.95 - 4.55	3.25 - 4.95
20		13.70	2.95 - 5.30	4.00 - 5.70	3.30 - 5.30	2.95 - 5.30	4.00 - 5.70
39		14.45	3.05 - 6.05	4.75 - 6.45	4.05 - 6.05	3.05 - 6.05	4.75 - 6.45
52		15.20	3.80 - 6.80	5.50 - 7.20	4.80 - 6.80	3.80 - 6.80	5.50 - 7.20
43		15.70	4.30 - 7.30	6.00 - 7.70	5.30 - 7.30	4.30 - 7.30	6.00 - 7.70
68		16.40	5.00 - 8.00	6.70 - 8.40	6.00 - 8.00	5.00 - 8.00	6.70 - 8.40
21		17.10	5.70 - 8.70	7.40 - 9.10	6.70 - 8.70	5.70 - 8.70	7.40 - 9.10

A

A



This document is the property of and embodies CONFIDENTIAL and PROPRIETARY information of FCI. No part of the information shown on this document may be used in any way or disclosed to others without the written consent of FCI. Copyright FCI.

\* STUB PINS - NO REAR PLUG-UP

\*\* THE GREATEST RANGE OCCURS WHEN THE B DIMENSION OF PIN 'GND' IS ONE SIZE SHORTER THEN THE OTHER PINS.

mat'l code SEE NOTE 5				tolerances unless otherwise specified		CUSTOMER		www.fciconnect.com	
ltr	ecn no.	dr	date	linear	0.X ±0.3		COPY		
T					0.XX ±0.13		projection		
					.XXX ±.051				
				angles	0° ±2°				title VERTICAL SIGNAL HDR 8 ROW P.F. 96 POS. SPECIAL LOAD EXT.  product family METRAL 2000 size dwg no 74978 code 213 sheet 3
				dr	E. KROPER.	2001-01-10	scale 1:1		
				engr	J. VOLSTORF	2001-01-10	A		
				chr	J. VOLSTORF	2001-01-10			
				appd	J. VOLSTORF	2001-01-10			
sheet index	revision sheet								

B

B

PRODUCT NUMBER  
SEE SHEET 1

PRESS-FIT HOLES	OPTION 1
HOLE DIAMETER AFTER PLATING	0.65-0.80
DRILLED HOLE	0.81-0.86 (0.85 DRILL)
COPPER PLATING	0.025 MIN
SnPb PLATING	0.005-0.015

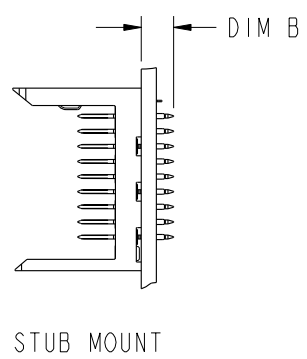
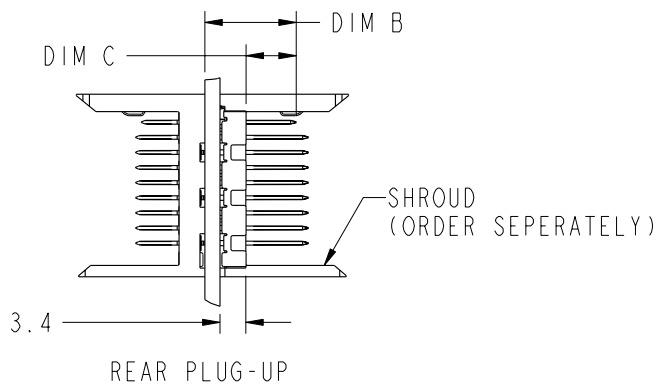

SEE PRINT 58351 FOR ADDITIONAL PCB INFORMATION.

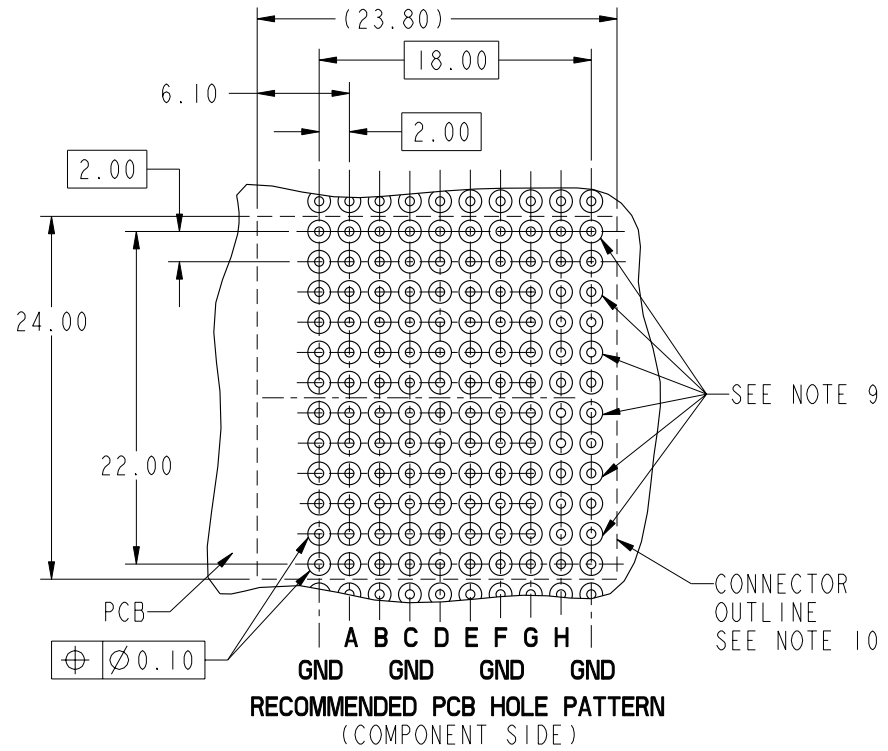

This document is the property of and embodies  
 CONFIDENTIAL and PROPRIETARY information of FCI.  
 No part of the information shown on this  
 document may be used in any way or disclosed  
 to others without the written consent of FCI.  
 Copyright FCI.

mat'l code SEE NOTE 5		tolerances unless otherwise specified		CUSTOMER		FCI www.fciconnect.com	
ltr	ecr no.	dr	date	linear	0.X ±0.3	COPY	
T				angles	0.XX ±0.13	projection	
					.XXX ±.051		
					0° ±2°		
		dr	E. KROPER.	2001-01-10	MM		product family
		enr	J. VOLSTORF	2001-01-10	← MM →		METRAL 2000
		chr	J. VOLSTORF	2001-01-10	scale		code
		appd	J. VOLSTORF	2001-01-10	1:1		213
sheet	revision						size
index	sheet						dwg no
							74978
							sheet
							4

cage code 22526



This document is the property of and embodies CONFIDENTIAL and PROPRIETARY information of FCI. No part of the information shown on this document may be used in any way or disclosed to others without the written consent of FCI. Copyright FCI.

SPECIAL LOAD PATTERNS		
PRODUCT #	ROW	PIN CODES
74978-X02001 SEE NOTE 16 LEAD FREE OPTION	H	01
	G	
	F	
	E	
	D	
	C	
	B	
	A	
	GND	
74978-X02006 *RPU SEE NOTE 16 LEAD FREE OPTION	H	48
	G	
	F	
	E	
	D	
	C	
	B	
	A	
	GND	
74978-X02011 SEE NOTE 16 LEAD FREE OPTION	H	02
	G	
	F	
	E	
	D	
	C	
	B	
	A	
	GND	
74978-X02012 *RPU SEE NOTE 16 LEAD FREE OPTION	H	44
	G	
	F	
	E	
	D	
	C	
	B	
	A	
	GND	
74978-X02013 *RPU SEE NOTE 16 LEAD FREE OPTION	H	06
	G	
	F	
	E	
	D	
	C	
	B	
	A	
	GND	

PCB THICKNESS  
RANGE FOR REAR  
PLUG UP  
APPLICATIONS:  
5.50 - 6.80

PCB THICKNESS  
RANGE FOR REAR  
PLUG UP  
APPLICATIONS:  
2.95 - 3.80

PCB THICKNESS  
RANGE FOR REAR  
PLUG UP  
APPLICATIONS:  
3.30 - 4.95 FOR  
METRAL 1000  
(RECEPTACLE)  
APPLICATIONS,  
AND 3.30-4.95  
FOR METRAL 4000  
APPLICATIONS

SPECIAL LOAD PATTERNS		
PRODUCT #	ROW	PIN CODES
74978-X02050 SEE NOTE 16 LEAD FREE OPTION	H	02
	G	03
	F	04
	E	02
	D	03
	C	04
	B	02
	A	03
	GND	02
	74978-X02051 *RPU SEE NOTE 16 LEAD FREE OPTION	H
G		24
F		12
E		25
D		24
C		12
B		25
A		24
GND		49
74978-X02052 *RPU SEE NOTE 16 LEAD FREE OPTION		H
	G	
	F	
	E	
	D	
	C	
	B	
	A	
	GND	
	74978-X02053 SEE NOTE 16 LEAD FREE OPTION	H
G		
F		
E		
D		
C		
B		
A		
GND		

PCB THICKNESS  
RANGE FOR REAR  
PLUG UP  
APPLICATIONS:  
5.70 - 7.20 FOR  
METRAL 1000  
(RECEPTACLE)  
APPLICATIONS,  
AND 6.00-7.20  
FOR METRAL 4000  
APPLICATIONS

PCB THICKNESS  
RANGE FOR REAR  
PLUG UP  
APPLICATIONS:  
2.95 - 5.30 FOR  
METRAL 1000  
(RECEPTACLE)  
APPLICATIONS,  
AND 3.30-5.30  
FOR METRAL 4000  
APPLICATIONS

PCB THICKNESS  
RANGE FOR REAR  
PLUG UP  
APPLICATIONS:  
4.00 - 5.70 FOT  
METRAL 1000  
(RECEPTACLE)  
APPLICATIONS,  
AND 4.05 - 5.70  
FOR METRAL 4000  
APPLICATIONS

SPECIAL LOAD PATTERNS		
PRODUCT #	ROW	PIN CODES
74978-X02054 SEE NOTE 16 LEAD FREE OPTION	H	03
	G	
	F	
	E	
	D	
	C	
	B	
	A	
	GND	
	GND	02

\*REAR PLUG-UP PART NUMBER

mat'l code SEE NOTE 5				tolerances unless otherwise specified		CUSTOMER	FCI www.fciconnect.com		
ltr	ecn no.	dr	date	linear	0.X ±0.3	projection	COPY		
T					0.XX ±0.13			title VERTICAL SIGNAL HDR 8 ROW P.F. 96 POS. SPECIAL LOAD EXT.	
					.XXX ±.051			product family METRAL 2000 code	
				angles	0° ±2°		size		
				dr	E. KROPER. 2001-01-10		dwg no		
				engr	J. VOLSTORF 2001-01-10		213		
				chr	J. VOLSTORF 2001-01-10		sheet		
				appd	J. VOLSTORF 2001-01-10	5			
sheet index	revision sheet					scale	1:1		

cage code 22526

PRODUCT NUMBER

SEE SHEET 1

NOTES:

- 1. SEE APPLICATION SPECIFICATION GS-20-010 FOR INFORMATION ON AVAILABLE TOOLING, CIRCUIT BOARD DESIGN CONSIDERATIONS, REPAIR PROCEDURES AND PRODUCT OFFERINGS.
- 2. SEE FCI PUBLICATION 950511-028 FOR "ELECTRICAL PERFORMANCE DATA FOR DIFFERENTIAL APPLICATIONS."
- 3. SEE FCI PUBLICATION 950511-028 FOR "ELECTRICAL PERFORMANCE DATA FOR SINGLE-ENDED APPLICATION."
- 4. UNLESS OTHERWISE SPECIFIED, ALL DIMENSIONS AND TOLERANCES ARE IN ACCORDANCE WITH ASME Y14.5M, 1994
- 5. HOUSING MATERIAL: LIQUID CRYSTAL POLYMER, 30% GLASS FILLED, FLAME RETARDANT PER UL 94-V0.  
PIN MATERIAL: PHOSPHER BRONZE  
GROUND SPRING MATERIAL: PHOSPHER BRONZE  
STRIPLINE SHIELD MATERIAL: PHOSPHER BRONZE
- 6. PLATING INFORMATION: PLATING ON CONTACT AREA MEETS THE PERFORMANCE LEVELS AS SHOWN IN TABLE ON SHEET 1. PLATING ON "LF" TAILS IS Sn. PLATING ON ALL OTHER TAILS IS SnPb.
- 7. DIMENSIONAL RESTRICTIONS OF PINS IN HEADERS.  
FOR MATING WITH METRAL 1000 RECEPTACLES  
DIM A : 5.00mm MIN, 8.00mm MAX FOR ROWS A-H  
DIM A : 5.00mm MIN, 5.75mm MAX FOR ROW GND NEXT TO ROW A  
DIM C : 5.00mm MIN, 8.00mm MAX FOR ROWS A-H  
DIM C : 4.60mm MIN, 6.30mm MAX FOR ROW GND NEXT TO ROW A  
FOR MATING WITH METRAL 4000 RECEPTACLES  
DIM A : 5.00mm MIN, 6.50mm MAX FOR ROWS A, B, D, E, G & H  
DIM A : 5.00mm MIN, 8.00mm MAX FOR ROWS C & F  
DIM A : 5.00mm MIN, 5.75mm MAX FOR ROW GND NEXT TO ROW A  
DIM C : 5.00mm MIN, 7.00mm MAX FOR ROWS A, B, D, E, G & H  
DIM C : 5.00mm MIN, 8.00mm MAX FOR ROWS C & F  
DIM C : 4.60mm MIN, 6.30mm MAX FOR ROW GND NEXT TO ROW A
- 8. THE MIN PCB THICKNESS FOR REAR PLUG-UP APPLICATIONS IS 2.9mm SINCE THE COMPLIANT SECTIONS OF THE GROUND SPRING OF THE HEADER DIRECTLY OPPOSE THE GROUND SPRING OF THE SHROUD. THE MIN PCB THICKNESS FOR FRONT PLUG-UP ONLY APPLICATIONS IS 1.6mm.

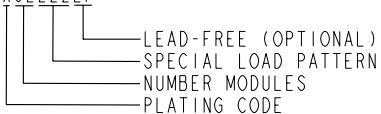
- 9. THESE HOLES ARE NEEDED FOR REAR PLUG-UP DESIGNS USING A SHROUD AND MAY BE OMITTED FOR FRONT PLUG-UP ONLY DESIGNS.
- 10. THE 'CONNECTOR OUTLINE' IS THE MIN OUTLINE REQUIRED. TO DETERMINE THE OUTLINE NECESSARY TO PERMIT THE VARIOUS TYPES OF REPAIR OPERATIONS, SEE APPLICATION SPECIFICATION GS-20-010.
- 11. CURRENT RATING : 1 AMP PER PIN
- 12. TEMPERATURE RANGE : -55°C TO +105°C
- 13. P/N 74978-X02ZZZLF  

- 14. FOR FRONT PLUG-UP APPLICATIONS, THE EVEN NUMBERED PINS IN ROW 'C' AND 'F' CAN BE USED FOR POWER AS WELL AS FOR GROUND. IF THE SURROUNDING PINS ARE NOT USED FOR POWER, THEN EACH PIN CAN CARRY 3 AMPS. IF THE SURROUNDING PINS ARE USED FOR POWER, THEN EACH PIN CAN CARRY 1 AMP. WHEN THE SURROUNDING PINS ARE USED ONLY FOR LOW SPEED SIGNALS, THEN THE EVEN NUMBERED 'C' AND 'F' ROW PINS CAN ALSO BE USED FOR LOW SPEED SIGNALS. THIS IS NOT TRUE FOR REAR PLUG-UP APPLICATIONS USING METRAL 2000 SHROUD AS IN THIS CASE ALL 'C' AND 'F' ROW PINS ARE COMMON TO GROUND.
- 15. PRODUCTS WHERE THE PART NUMBER ENDS IN LF MEET EUROPEAN UNION DIRECTIVES AND OTHER COUNTRY REGULATIONS AS DESCRIBED IN GS-22-008. ALL PRODUCTS WILL WITHSTAND EXPOSURE TO 260°C FOR 60 SECONDS IN A CONVECTION, INFRA-RED OR VAPOR PHASE REFLOW OVEN.
- 16. FOR LEAD FREE PART NUMBERS ADD 'LF' SUFFIX. EXAMPLE: 74978-XXXXLF
- 17. PIN TYPE IS AT THE MANUFACTURERS OPTION AND CAN BE EITHER BABY-H OR EYE OF THE NEEDLE STYLE

A

A



This document is the property of and embodies CONFIDENTIAL and PROPRIETARY information of FCI. No part of the information shown on this document may be used in any way or disclosed to others without the written consent of FCI. Copyright FCI.

B

B

mat'l code SEE NOTE 5				tolerances unless otherwise specified		CUSTOMER	FCI www.fciconnect.com	
ltr	ecn no.	dr	date	linear	0.X ±0.3	COPY	title VERTICAL SIGNAL HDR 8 ROW P.F. 96 POS. SPECIAL LOAD EXT.	
T					0.XX ±0.13	projection		
					.XXX ±.051			
				angles	0° ±2°		product family METRAL 2000 code	
				dr	E. KROPER. 2001-01-10	MM	size	213
				enrg	J. VOLSTORF 2001-01-10	← MM →	dwg no	6
				chr	J. VOLSTORF 2001-01-10	scale	A	74978
				appd	J. VOLSTORF 2001-01-10	1:1		sheet
sheet index	revision sheet							6

# Mouser Electronics

Authorized Distributor

Click to View Pricing, Inventory, Delivery & Lifecycle Information:

## [FCI / Amphenol:](#)

[74978-102001](#) [74978-102011LF](#) [74978-102006](#) [74978-102051](#) [74978-502011](#) [74978-102011](#) [74978-102001LF](#)  
[74978-102012LF](#) [74978-102013LF](#) [74978-102050LF](#) [74978-102053LF](#) [74978-102054LF](#) [74978-102006LF](#) [74978-](#)  
[102051LF](#) [74978-302001LF](#) [74978-502011LF](#) [74978-102012](#) [74978-102013](#) [74978-102050](#) [74978-102053](#) [74978-](#)  
[102054](#)