

PIN Diode Limiter 50 MHz - 4 GHz

Rev. V2

Features

- Low Insertion Loss and Noise Figure
- +40 dBm Peak and +30 dBm CW Power
- +10 dBm P1dB Compression Point
- +16 dBm Flat Leakage
- Lead-Free 1.2 x 1.5 mm 6-Lead PQFN Package
- RoHS Compliant* and 260°C Reflow Compatible

Description

The MADL-011008 is a silicon PIN limiter with small I-region length specifically designed for medium signal applications. The limiter is available in a lead-free 1.2 x 1.5 mm 6-lead PQFN package. The limiter is ideally designed to provide low insertion loss, at zero bias, as well as low flat leakage power with fast signal response/recovery times.

The MADL-011008 PIN limiter is designed for use in passive limiter control circuits to protect sensitive receiver components such as low noise amplifiers (LNA), detectors, and mixers.

Ordering Information^{1,2}

Part Number	Package
MADL-011008-141200	Bulk Packaging
MADL-011008-14120T	Tape and Reel
MADL-011008-001SMB	Sample Test Board

1. Reference Application Note M513 for reel size information.
2. All sample boards include 5 loose pieces.

Functional Schematic

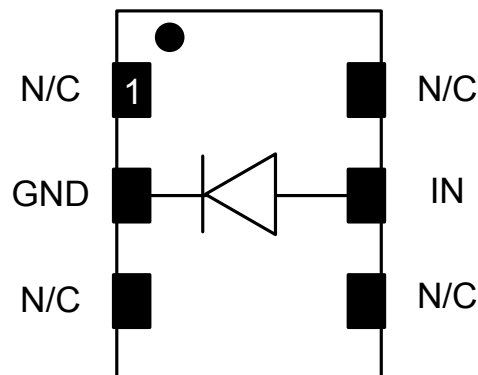

Pin Configuration

Pin No.	Pin Name	Description
1	N/C	No Connection
2	GND	RF Ground
3	N/C	No Connection
4	N/C	No Connection
5	IN	RF Input
6	N/C	No Connection
7 ³	Pad	GND

3. The exposed pad centered on the package bottom must be connected to RF and DC ground.

Handling Procedures

Please observe the following precautions to avoid damage:

Static Sensitivity

Silicon Integrated Circuits are sensitive to electrostatic discharge (ESD) and can be damaged by static electricity. Proper ESD control techniques should be used when handling these devices.

* Restrictions on Hazardous Substances, European Union Directive 2002/95/EC.

PIN Diode Limiter 50 MHz - 4 GHz

Rev. V2

Electrical Specifications: Freq 2.7 to 3.0 GHz, $T_A = 25^\circ\text{C}$, $Z_0 = 50 \Omega$

Parameter	Test Conditions	Units	Min.	Typ.	Max.
Insertion Loss	0 dBm	dB	—	0.15	—
Input Return Loss	0 dBm	dB	—	20	—
Output Return Loss	0 dBm	dB	—	20	—
P1dB	—	dBm	—	10	—
Peak Incident Power	Pulse Width 1 μSec , Duty Cycle 0.1%	dBm	—	40	—
CW Incident Power	—	dBm	—	30	—
CW Flat Leakage	Incident Power = +24 dBm	dBm	—	16	—
Recovery Time	To within 1 dB of final insertion loss Peak Incident Power = +30 dBm Pulse Width 1 μSec , Duty Cycle 0.1%	ns	—	50	—
Spike Leakage	+30 dBm Pin, Pulse Width 1 μSec , Duty Cycle 0.1%	erg	—	0.5	—
IP3	Pin -5 dBm/tone, 10 MHz Spacing	dBm	—	30	—
IP2	Pin -5 dBm/tone	dBm	—	43	—
Forward Voltage	Forward current = 10 mA	V	—	0.9	1.1
Reverse Current	Reverse voltage = 20 volts	μA	—	0.1	100

Absolute Maximum Ratings^{4,5}

Parameter	Absolute Maximum
Peak Incident Power Pulse Width 1 μSec , Duty Cycle 0.1%	43 dBm
CW Incident Power	33 dBm
Operating Temperature	-40°C to $+85^\circ\text{C}$
Storage Temperature	-65°C to $+150^\circ\text{C}$

- Exceeding any one or combination of these limits may cause permanent damage to this device.
- M/A-COM Technology Solutions does not recommend sustained operation near these survivability limits.

Application Schematic

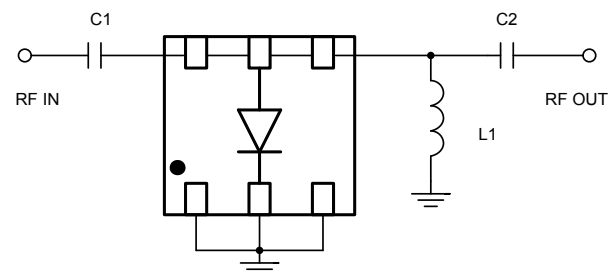

Recommended Board Layout

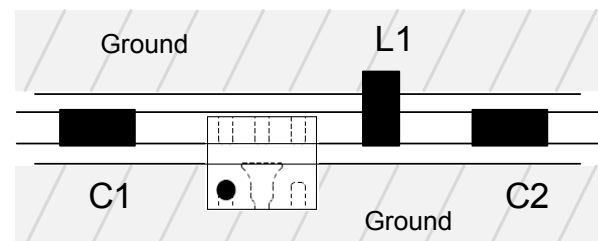

Parts List

Component	Value	Package
C1 - C2	68 pF	0402
L1	5.1 nH	0402

Typical Performance Curves

Insertion Loss

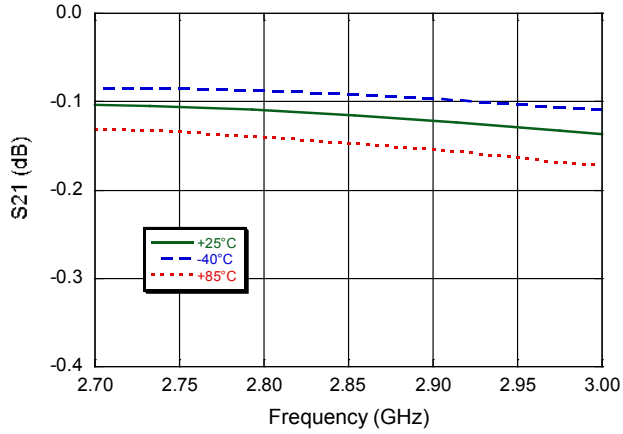

Pin vs. Pout @ 2.85 GHz

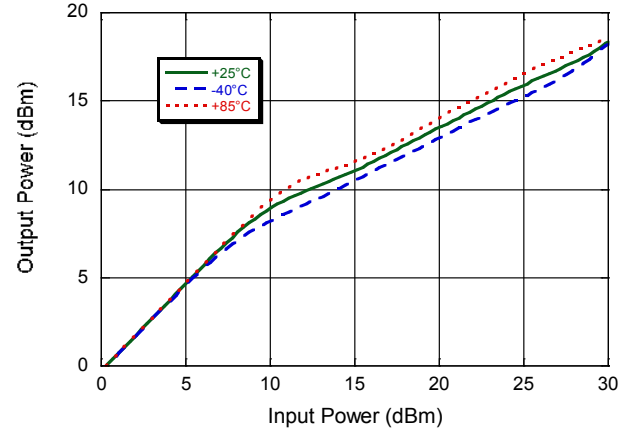

Input Return loss

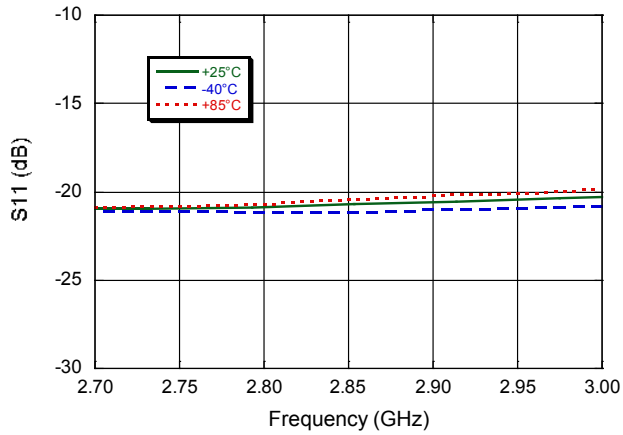

Output Return Loss

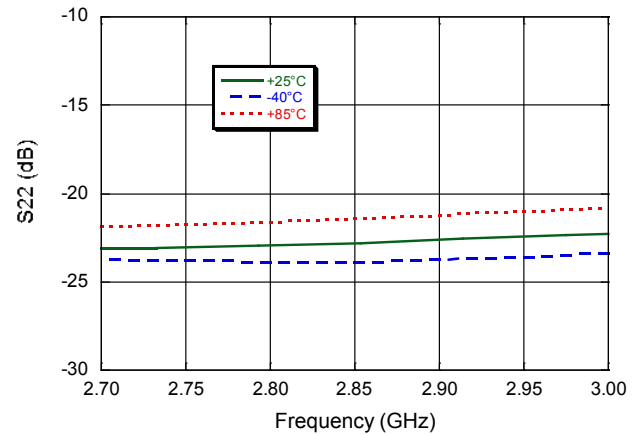

Lead-Free 1.2 x 1.5 mm 6-Lead PQFN[†]

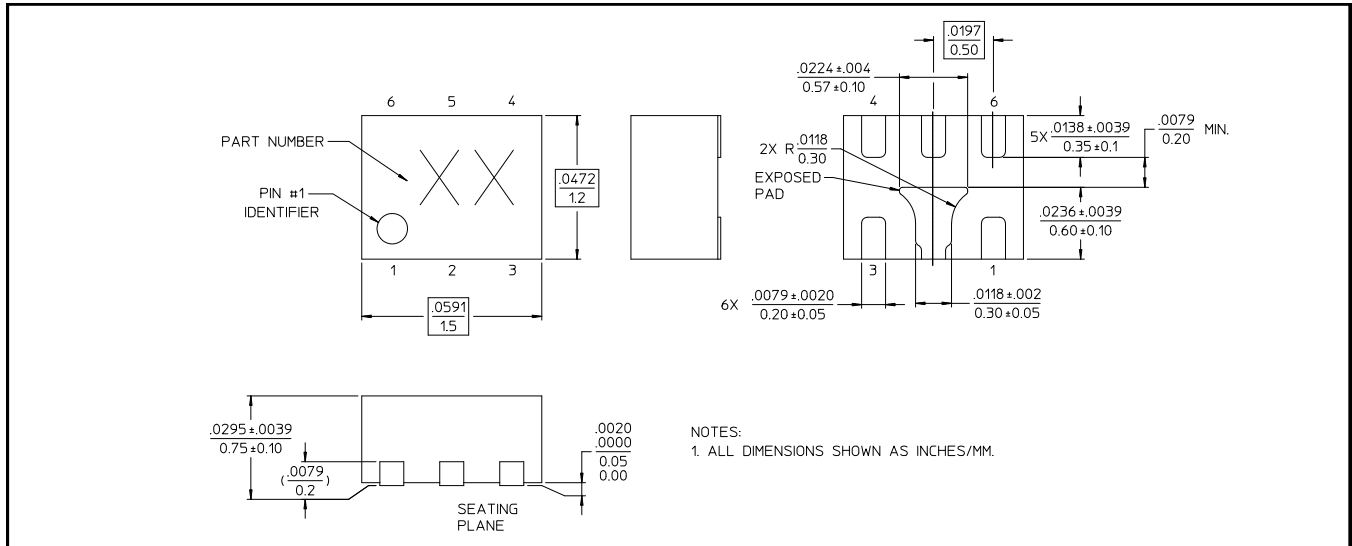

[†] Reference Application Note M538 for lead-free solder reflow recommendations.
 Meets JEDEC moisture sensitivity level 1 requirements.
 Plating is 100% matte tin over copper.

M/A-COM Technology Solutions Inc. All rights reserved.

Information in this document is provided in connection with M/A-COM Technology Solutions Inc ("MACOM") products. These materials are provided by MACOM as a service to its customers and may be used for informational purposes only. Except as provided in MACOM's Terms and Conditions of Sale for such products or in any separate agreement related to this document, MACOM assumes no liability whatsoever. MACOM assumes no responsibility for errors or omissions in these materials. MACOM may make changes to specifications and product descriptions at any time, without notice. MACOM makes no commitment to update the information and shall have no responsibility whatsoever for conflicts or incompatibilities arising from future changes to its specifications and product descriptions. No license, express or implied, by estoppel or otherwise, to any intellectual property rights is granted by this document.

THESE MATERIALS ARE PROVIDED "AS IS" WITHOUT WARRANTY OF ANY KIND, EITHER EXPRESS OR IMPLIED, RELATING TO SALE AND/OR USE OF MACOM PRODUCTS INCLUDING LIABILITY OR WARRANTIES RELATING TO FITNESS FOR A PARTICULAR PURPOSE, CONSEQUENTIAL OR INCIDENTAL DAMAGES, MERCHANTABILITY, OR INFRINGEMENT OF ANY PATENT, COPYRIGHT OR OTHER INTELLECTUAL PROPERTY RIGHT. MACOM FURTHER DOES NOT WARRANT THE ACCURACY OR COMPLETENESS OF THE INFORMATION, TEXT, GRAPHICS OR OTHER ITEMS CONTAINED WITHIN THESE MATERIALS. MACOM SHALL NOT BE LIABLE FOR ANY SPECIAL, INDIRECT, INCIDENTAL, OR CONSEQUENTIAL DAMAGES, INCLUDING WITHOUT LIMITATION, LOST REVENUES OR LOST PROFITS, WHICH MAY RESULT FROM THE USE OF THESE MATERIALS.

MACOM products are not intended for use in medical, lifesaving or life sustaining applications. MACOM customers using or selling MACOM products for use in such applications do so at their own risk and agree to fully indemnify MACOM for any damages resulting from such improper use or sale.