

THIS DRAWING IS UNPUBLISHED. RELEASED FOR PUBLICATION
 © COPYRIGHT - BY TYCO ELECTRONICS CORPORATION. ALL RIGHTS RESERVED.

LOC	DIST	REVISIONS			
P	LTR	DESCRIPTION	DATE	DWN	APVD
H	-				
	13	TOLERANCE CHANGE DIM A08	12APR2010	PW	JD
	A	ECR-10-016181	29JUL2010	PW	JD

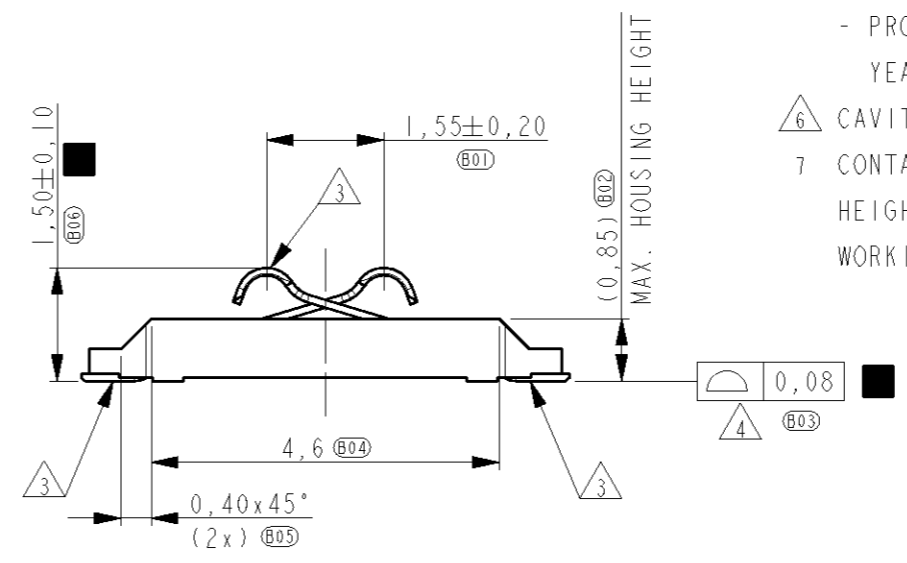
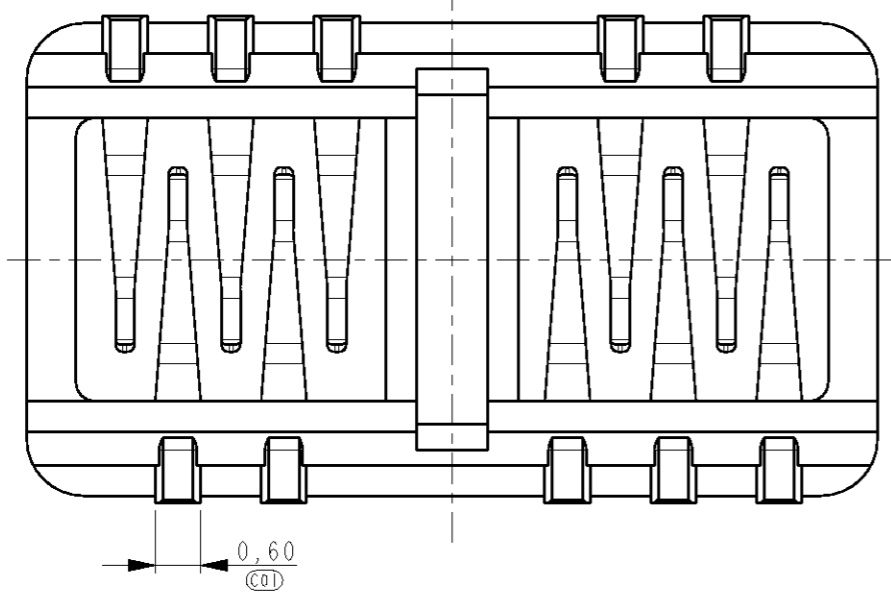
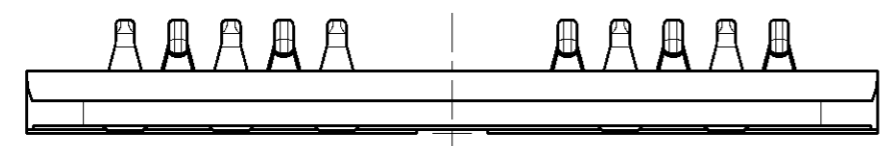
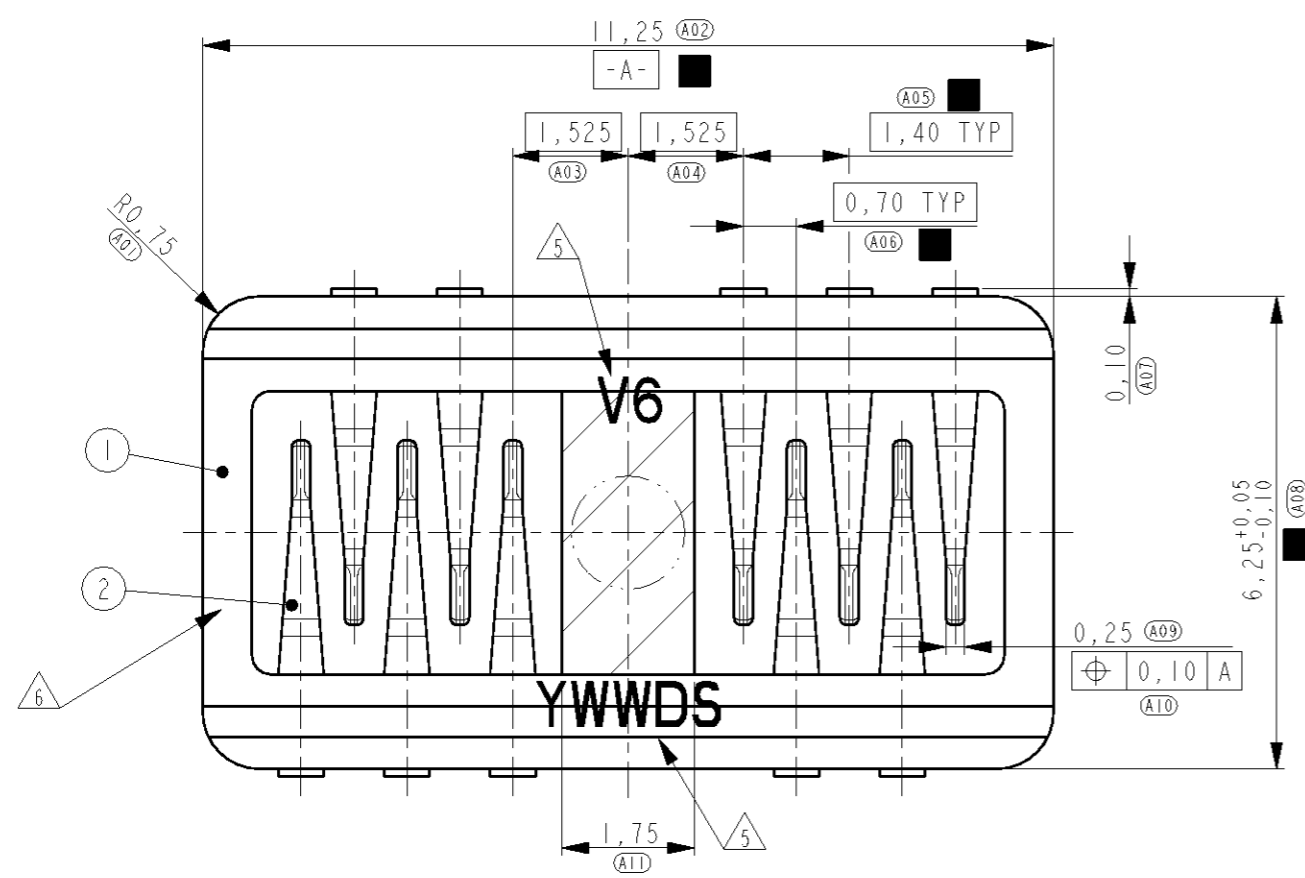

NOTES:

- P.N. AS SHOWN 1551246-2.
- DRAWING REPRESENTS PART VERSION V6.
- PLATING: 1,27µm MIN. NICKEL ALL OVER, 0,5µm MIN GOLD ON CONTACT POINTS, GOLD FLASH ON SOLDER TAILS.
- COPLANARITY OF SOLDER SURFACES 0,08 MAX.
- LASER MARKING:
- PART VERSION ('V6'),
- PRODUCTION DATE CODE ('YWWDS'
YEAR, WEEK, DAY + DAY/NIGHT SHIFT)
- CAVITY ID, RECESSED.
- CONTACT NORMAL FORCE 0,3N AT NOMINAL WORKING HEIGHT OF 0,95mm MEASURED FROM THE PWB. WORKING RANGE IS ±0,10mm (0,85 - 1,05mm)

ITEM NO.	DESCRIPTION	MATERIAL	FINISH
2	CONTACT	COPPER ALLOY	GOLD PLATED
1	HOUSING	PLASTIC, GF	-

THIS DRAWING IS A CONTROLLED DOCUMENT FOR TYCO ELECTRONICS CORPORATION IT IS SUBJECT TO CHANGE AND THE CONTROLLING ENGINEERING ORGANIZATION SHOULD BE CONTACTED FOR THE LATEST REVISION.

DIMENSIONS:		TOLERANCES UNLESS OTHERWISE SPECIFIED:	
mm			
	0 PLC	±0,2	
	1 PLC	±0,1	
	2 PLC	±0,05	
	3 PLC	±-	
	4 PLC	±-	
	ANGLES	±-	
MATERIAL		FINISH	

DWN	07-May-09	Tyco Electronics Corporation	
CHK	P. Willems	's-Hertogenbosch, Nederland	
APVD	M. Gosselink	NAME	
PRODUCT SPEC	J. Dittner	10 POS DOUBLE ROW B+B CONNECTOR	
APPLICATION SPEC	108-19392	SIZE	RESTRICTED TO
WEIGHT	0,055 gr	CAGE CODE	
CUSTOMER DRAWING	A3	DRAWING NO	
		SCALE	
		SHEET	
		OF	
		REV	

THIS DRAWING IS UNPUBLISHED. RELEASED FOR PUBLICATION

© COPYRIGHT - BY TYCO ELECTRONICS CORPORATION. ALL RIGHTS RESERVED.

LOC	DIST	REVISIONS					
		P	LTR	DESCRIPTION	DATE	DWN	APVD
H	-	-	-	SEE SHEET 1	-	-	-

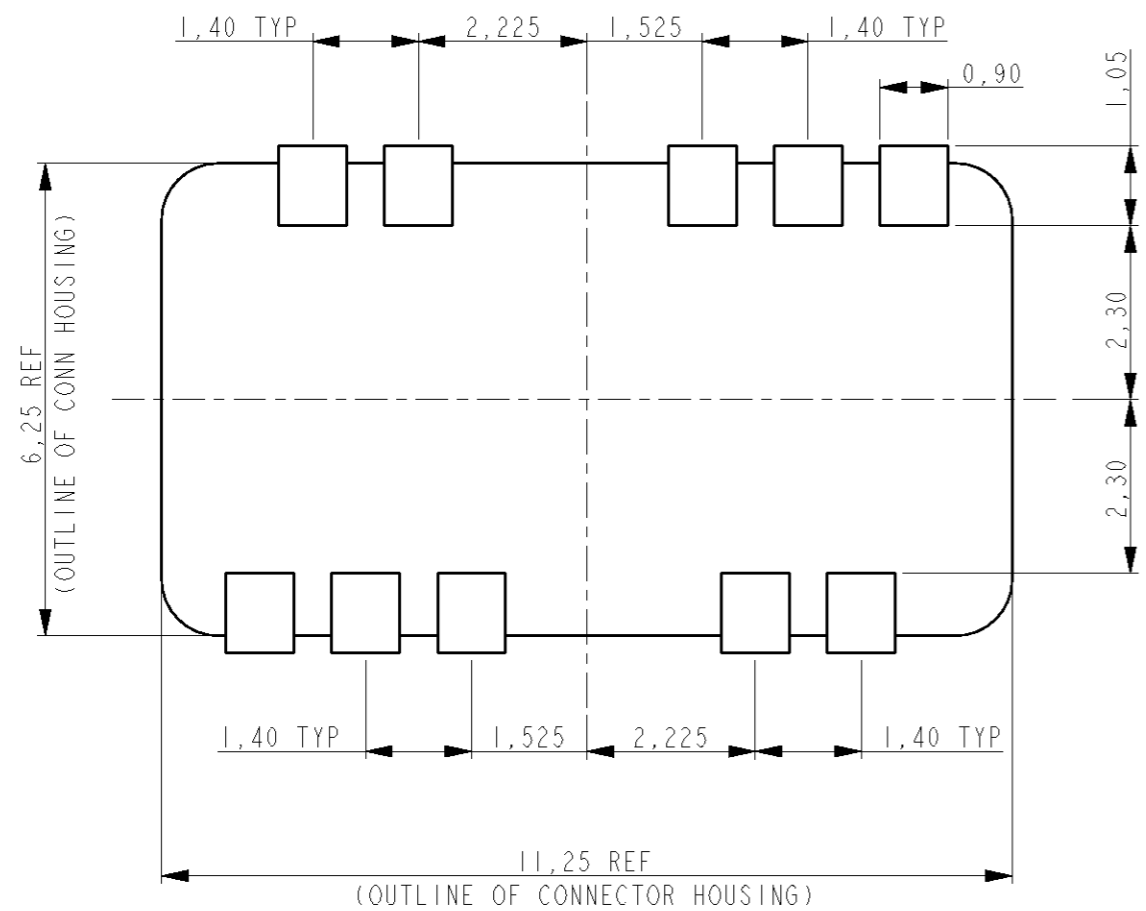

RECOMMENDED PWB LAY-OUT
PWB SOLDER SIDE

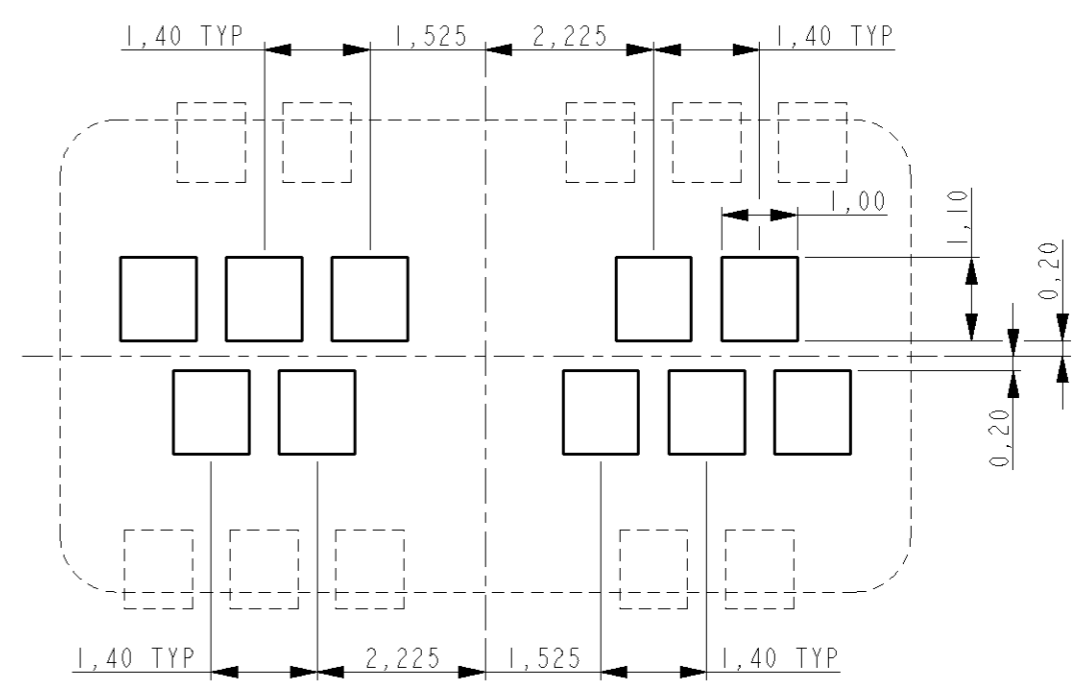

RECOMMENDED PWB LAY-OUT
PWB CONTACT SIDE

THIS DRAWING IS A CONTROLLED DOCUMENT FOR TYCO ELECTRONICS CORPORATION IT IS SUBJECT TO CHANGE AND THE CONTROLLING ENGINEERING ORGANIZATION SHOULD BE CONTACTED FOR THE LATEST REVISION.		DWN P. Willems 07-May-09	Tyco Electronics Tyco Electronics Corporation 's-Hertogenbosch, Nederland	
DIMENSIONS: mm	TOLERANCES UNLESS OTHERWISE SPECIFIED:	CHK M. Gosselink	NAME 10 POS DOUBLE ROW B+B CONNECTOR	
	0 PLC ±0,2 1 PLC ±0,1 2 PLC ±0,05 3 PLC ±- 4 PLC ±- ANGLES ±-	APVD J. Dittner	PRODUCT SPEC 108-19392	
MATERIAL	FINISH	APPLICATION SPEC -	SIZE A3	RESTRICTED TO -
		WEIGHT 0,055 gr	CAGE CODE 00779	DRAWING NO C=1551246
CUSTOMER DRAWING			SCALE 10:1	SHEET 2 OF 3
			REV A	

THIS DRAWING IS UNPUBLISHED. RELEASED FOR PUBLICATION

© COPYRIGHT - BY TYCO ELECTRONICS CORPORATION. ALL RIGHTS RESERVED.

LOC	DIST	REVISIONS			
P	LTR	DESCRIPTION	DATE	DWN	APVD
H	-	SEE SHEET 1	-	-	-

SECTION A-A

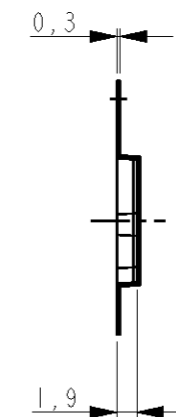
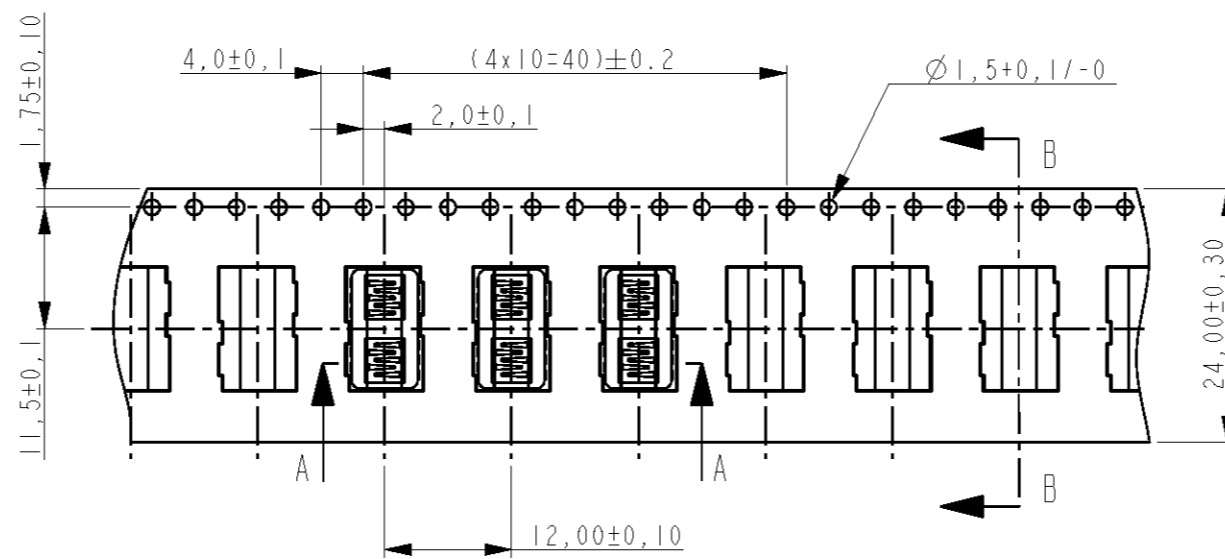

SECTION B-B

UNREEL DIRECTION →

NOTES:

- 1 REEL DIMENSIONS: 330x100x32,4mm
- 2 QTY PER REEL: 2500pcs

<small>THIS DRAWING IS A CONTROLLED DOCUMENT FOR TYCO ELECTRONICS CORPORATION IT IS SUBJECT TO CHANGE AND THE CONTROLLING ENGINEERING ORGANIZATION SHOULD BE CONTACTED FOR THE LATEST REVISION.</small>		DWN P. Willems 07-May-09 CHK M. Gosselink APVD J. Dittner		Tyco Electronics Corporation 's-Hertogenbosch, Nederland	
DIMENSIONS: mm		TOLERANCES UNLESS OTHERWISE SPECIFIED: 0 PLC ±0,2 1 PLC ±0,1 2 PLC ±0,05 3 PLC ±- 4 PLC ±- ANGLES ±-		NAME 10 POS DOUBLE ROW B+B CONNECTOR PRODUCT SPEC 108-19392 APPLICATION SPEC -	
MATERIAL -		FINISH -		WEIGHT 0,055 gr SIZE A3 CAGE CODE 00779 DRAWING NO 1551246 RESTRICTED TO -	
CUSTOMER DRAWING				SCALE 10:1 SHEET 3 OF 3 REV A	

Mouser Electronics

Authorized Distributor

Click to View Pricing, Inventory, Delivery & Lifecycle Information:

[TE Connectivity:](#)

[1551246-2](#)