

CMPA5585025F

25 W, 5.5 - 8.5 GHz, GaN MMIC, Power Amplifier

Cree's CMPA5585025F is a gallium nitride (GaN) High Electron Mobility Transistor (HEMT) based monolithic microwave integrated circuit (MMIC). GaN has superior properties compared to silicon or gallium arsenide, including higher breakdown voltage, higher saturated electron drift velocity and higher thermal conductivity. GaN HEMTs also offer greater power density and wider bandwidths compared to Si and GaAs transistors. This MMIC is available in a 10 lead metal/ceramic flanged package for optimal electrical and thermal performance.

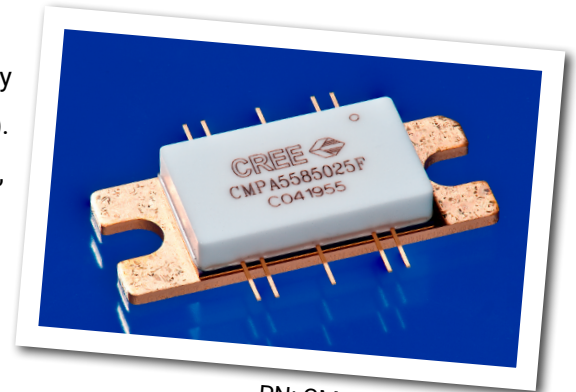

PN: CMPA5585025F
Package Type: 440213

Typical Performance Over 5.8-8.4 GHz ($T_c = 25^\circ\text{C}$)

Parameter	5.8 GHz	6.4 GHz	7.2 GHz	7.9 GHz	8.4 GHz	Units
Small Signal Gain	29.5	24.0	24.0	24.0	22.0	dB
Output Power ¹	15	23	20	19	19	W
Power Gain ¹	21.7	19.5	17.2	18.5	18.6	dB
Power Added Efficiency ¹	30	25	20.5	19	19.5	%

Note¹: Measured at -30 dBc, 1.6 MHz from carrier, in the CMPA5585025F-AMP under OQPSK modulation, 1.6 Msps, PN23, Alpha Filter = 0.2.

Features

- 25 dB Small Signal Gain
- 35 W Typical P_{SAT}
- Operation up to 28 V
- High Breakdown Voltage
- High Temperature Operation
- Size 1.00 x 0.385 inches

Applications

- Point to Point Radio
- Communications
- Satellite Communication Uplink

Absolute Maximum Ratings (not simultaneous)

Parameter	Symbol	Rating	Units	Conditions
Drain-source Voltage	V_{DSS}	84	V_{DC}	25°C
Gate-source Voltage	V_{GS}	-10, +2	V_{DC}	25°C
Power Dissipation	P_{DISS}	55	W	
Storage Temperature	T_{STG}	-65, +150	°C	
Operating Junction Temperature	T_J	225	°C	
Maximum Forward Gate Current	I_{GMAX}	10	mA	25°C
Soldering Temperature ¹	T_S	245	°C	
Screw Torque	τ	40	in-oz	
Thermal Resistance, Junction to Case	R_{JUC}	1.55	°C/W	OQPSK, 85°C, $P_{DISS} = 55$ W
Thermal Resistance, Junction to Case	R_{JUC}	1.80	°C/W	CW, 85°C, $P_{DISS} = 77$ W
Case Operating Temperature	T_C	-40, +140	°C	$P_{DISS} = 55$ W
Case Operating Temperature	T_C	-40, +85	°C	$P_{DISS} = 77$ W

Note:

¹ Refer to the Application Note on soldering at www.cree.com/RF/Document-Library

Electrical Characteristics (Frequency = 5.5 GHz to 8.5 GHz unless otherwise stated; $T_C = 25^\circ\text{C}$)

Characteristics	Symbol	Min.	Typ.	Max.	Units	Conditions
DC Characteristics¹						
Gate Threshold Voltage	$V_{GS(TH)}$	-3.8	-3.0	-2.3	V	$V_{DS} = 10$ V, $I_D = 13.2$ mA
Gate Quiescent Voltage	$V_{GS(Q)}$	-	-2.7	-	V_{DC}	$V_{DS} = 28$ V, $I_D = 285$ mA
Saturated Drain Current ²	I_{DS}	10.6	12.8	-	A	$V_{DS} = 6.0$ V, $V_{GS} = 2.0$ V
Drain-Source Breakdown Voltage	V_{BD}	84	100	-	V	$V_{GS} = -8$ V, $I_D = 13.2$ mA
RF Characteristics³						
Small Signal Gain	S21	18.25	24	-	dB	$V_{DD} = 28$ V, $I_{DQ} = 285$ mA, $P_{IN} = -20$ dBm
Input Return Loss	S11	-	10	-	dB	$V_{DD} = 28$ V, $I_{DQ} = 285$ mA
Output Return Loss	S22	-	6	-	dB	$V_{DD} = 28$ V, $I_{DQ} = 285$ mA
Output Mismatch Stress	VSWR	-	-	5:1	Ψ	No damage at all phase angles, $V_{DD} = 28$ V, $I_{DQ} = 285$ mA, $P_{OUT} = 25$ W OQPSK

Notes:

¹ Measured on-wafer prior to packaging.

² Scaled from PCM data.

³ Measured in the CMPA5585025F-AMP

Electrical Characteristics Continued... (T_c = 25°C)

Characteristics	Symbol	Min.	Typ.	Max.	Units	Conditions
RF Characteristics^{1,2,3,4}						
Power Added Efficiency	PAE1	24.5	30.0	–	%	V _{DD} = 28 V, I _{DQ} = 285 mA, Frequency = 5.8 GHz
Power Added Efficiency	PAE2	16.5	20.5	–	%	V _{DD} = 28 V, I _{DQ} = 285 mA, Frequency = 7.2 GHz
Power Added Efficiency	PAE3	15.5	19.0	–	%	V _{DD} = 28 V, I _{DQ} = 285 mA, Frequency = 7.9 GHz
Power Added Efficiency	PAE4	15.0	19.5	–	%	V _{DD} = 28 V, I _{DQ} = 285 mA, Frequency = 8.4 GHz
Power Gain	G _{P1}	19.5	21.7	–	dB	V _{DD} = 28 V, I _{DQ} = 285 mA, Frequency = 5.8 GHz
Power Gain	G _{P2}	16.25	17.2	–	dB	V _{DD} = 28 V, I _{DQ} = 285 mA, Frequency = 7.2 GHz
Power Gain	G _{P3}	16.55	18.5	–	dB	V _{DD} = 28 V, I _{DQ} = 285 mA, Frequency = 7.9 GHz
Power Gain	G _{P4}	16.75	18.6	–	dB	V _{DD} = 28 V, I _{DQ} = 285 mA, Frequency = 8.4 GHz
OQPSK Linearity	ACLR1	–	-36	-27.0	dB	V _{DD} = 28 V, I _{DQ} = 285 mA, Frequency = 5.8 GHz
OQPSK Linearity	ACLR2	–	-36	-28.5	dB	V _{DD} = 28 V, I _{DQ} = 285 mA, Frequency = 7.2 GHz
OQPSK Linearity	ACLR3	–	-36	-26.0	dB	V _{DD} = 28 V, I _{DQ} = 285 mA, Frequency = 7.9 GHz
OQPSK Linearity	ACLR4	–	-42	-32.5	dB	V _{DD} = 28 V, I _{DQ} = 285 mA, Frequency = 8.4 GHz

Notes:

¹ Measured in the CMPA5585025F-AMP

² Under OQPSK modulated signal, 1.6 Msps, PN23, Alpha Filter = 0.2.

³ Measured at P_{AVE} = 40 dBm.

⁴ Fixture loss de-embedded.

Electrostatic Discharge (ESD) Classifications

Parameter	Symbol	Class	Test Methodology
Human Body Model	HBM	1A (> 250 V)	JEDEC JESD22 A114-D
Charge Device Model	CDM	II (200 < 500 V)	JEDEC JESD22 C101-C

Typical Performance of the CMPA5585025F

Figure 1. CMPA5585025F Linear Output Power, Gain and PAE at -30 dBc, 1.6 MHz from carrier
 $V_{DD} = 28\text{ V}$, $I_{DQ} = 285\text{ mA}$, 1.6 Mps OQPSK Modulation

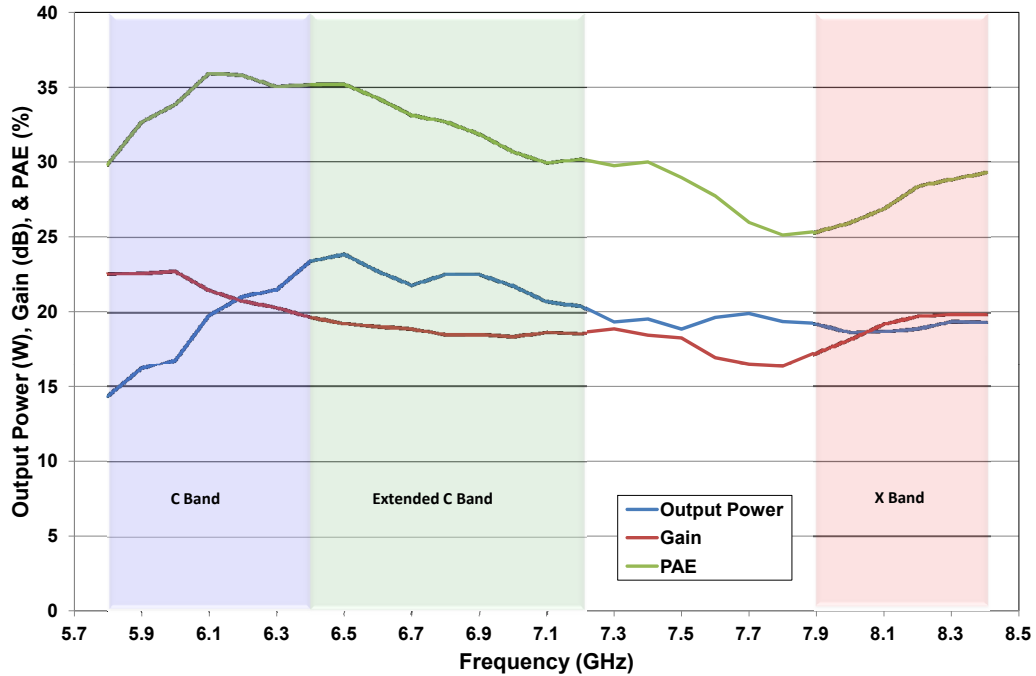
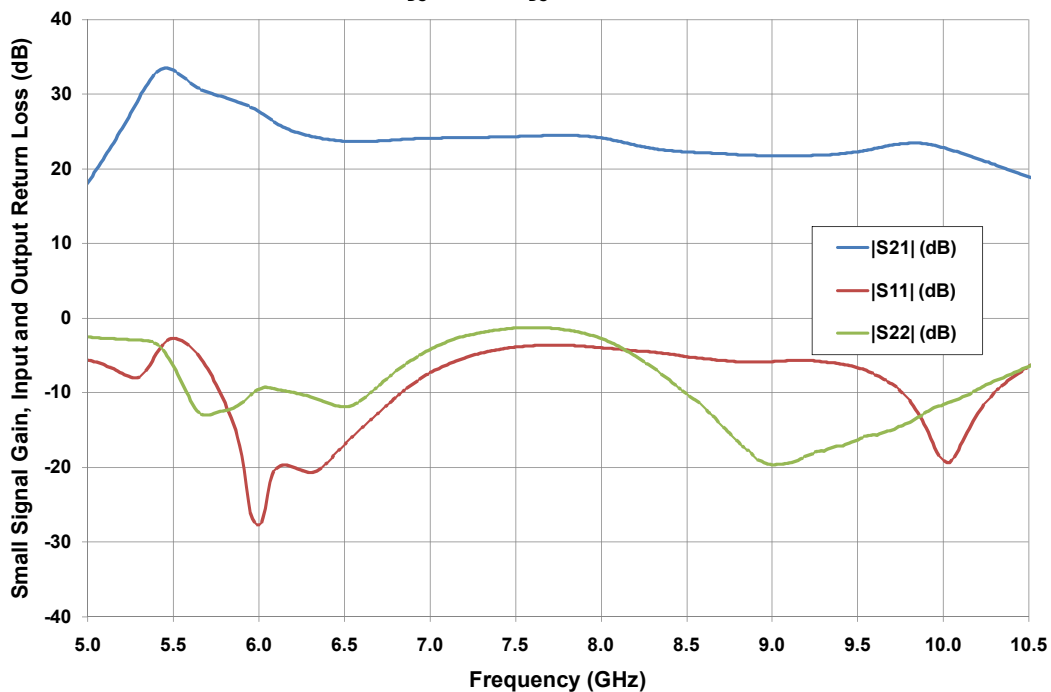

Figure 2. Typical Small Signal Gain and Return Loss vs Frequency of the CMPA5585025F measured in CMPA5585025F-AMP Amplifier Circuit.

$V_{DS} = 28\text{ V}$, $I_{DS} = 285\text{ mA}$



Typical Performance of the CMPA5585025F

Figure 3. CMPA5585025F C-band Spectral Mask at 15 W
 PAE = 29.1% at 5.8 GHz, 28.5% at 6.4 GHz & 25.6% at 7.2 GHz

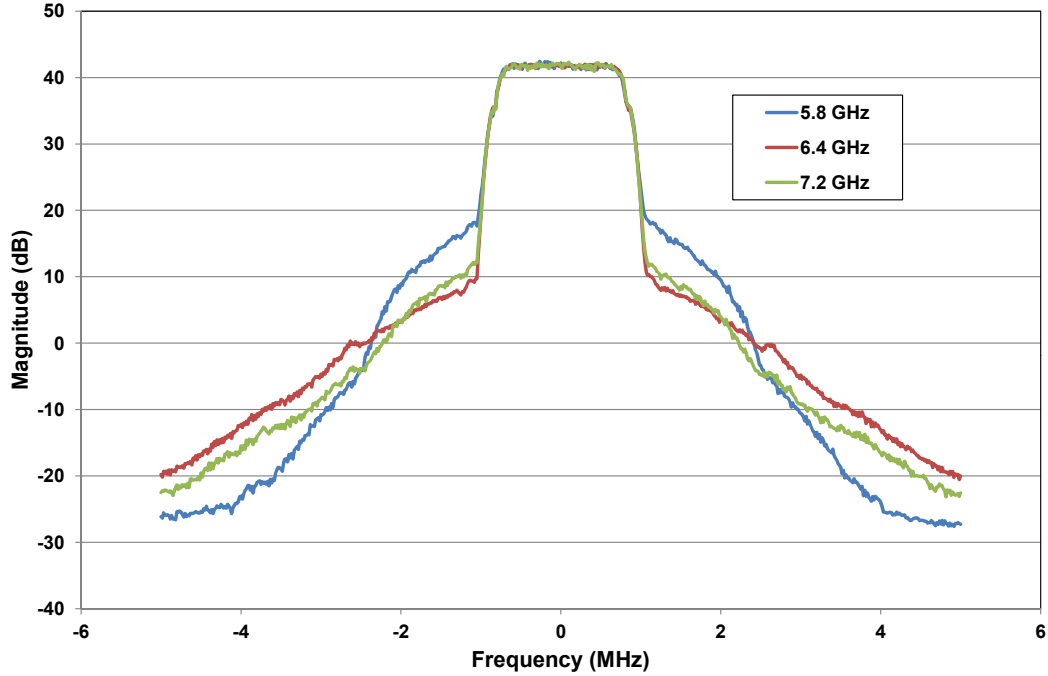
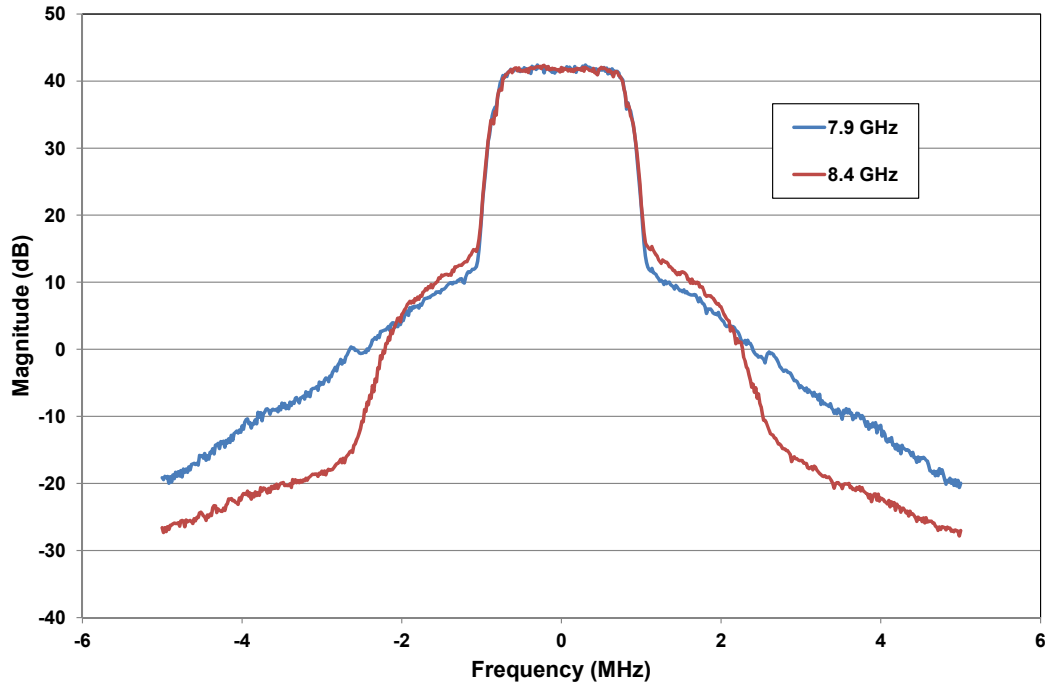

Figure 4. CMPA5585025F X-band Spectral Mask at 15 W
 PAE = 25.6% at 7.9 GHz & 25.3% at 8.4 GHz



Typical Performance of the CMPA5585025F

Figure 5. CMPA5585025F C-band Linearity, Gain, and PAE vs Average Output Power
 $V_{DS} = 28\text{ V}$, $I_{DS} = 285\text{ mA}$, OQPSK, 1.6 Msps

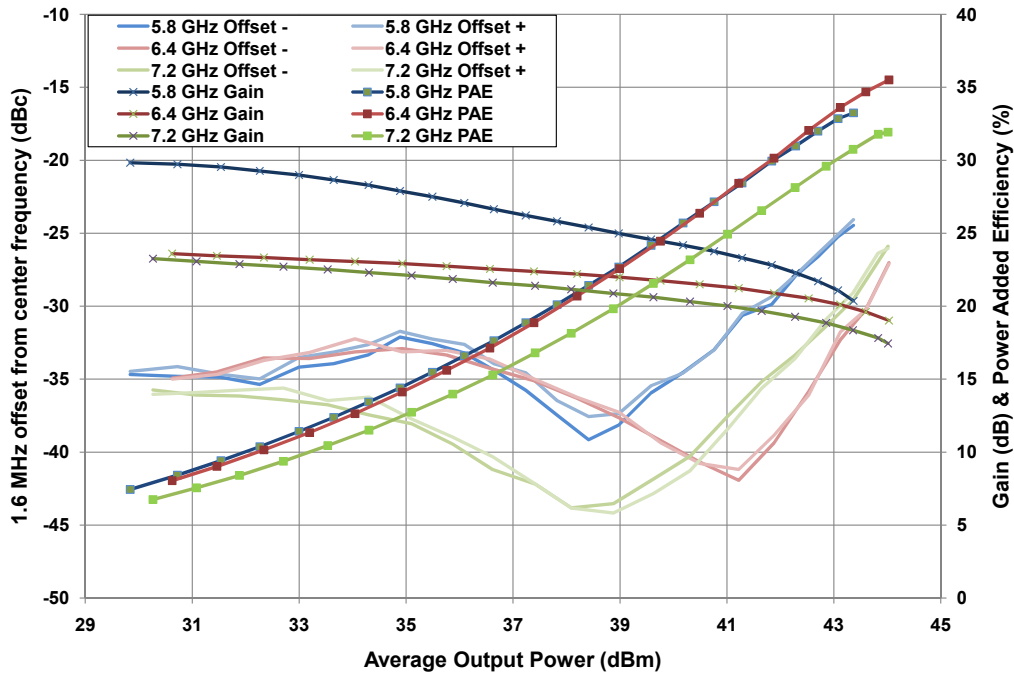
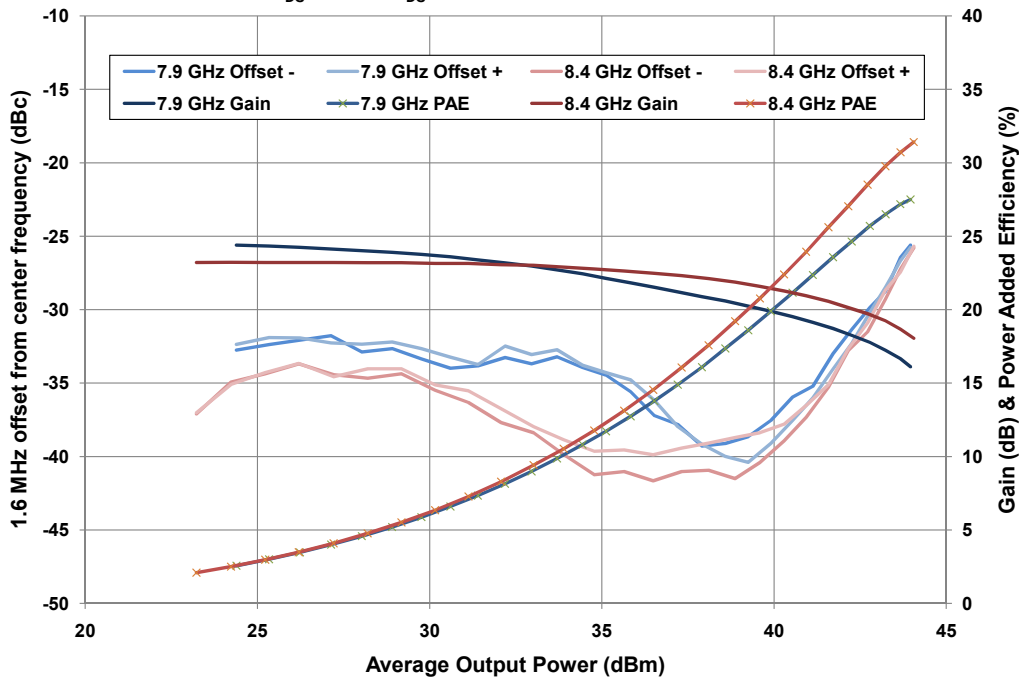

Figure 6. CMPA5585025F X-band Linearity, Gain, and PAE vs Average Output Power
 $V_{DS} = 28\text{ V}$, $I_{DS} = 285\text{ mA}$, OQPSK, 1.6 Msps



Typical Performance of the CMPA5585025F

Figure 7. CMPA5585025F EVM vs Average Output Power
 $V_{DS} = 28\text{ V}$, $I_{DS} = 285\text{ mA}$, 1.6 Msps OQPSK Modulation

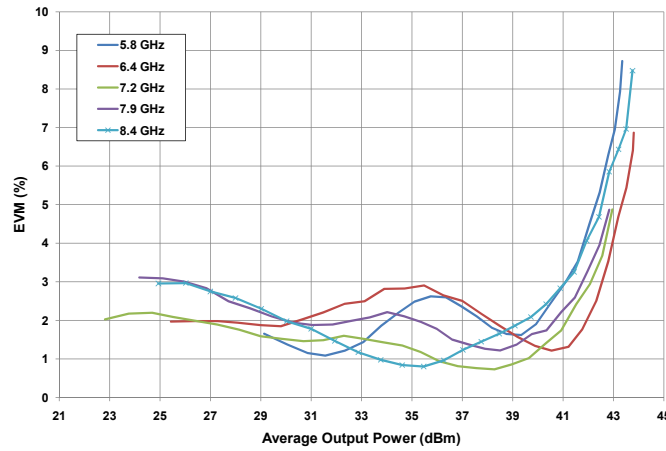

Figure 8. CMPA5585025F - Linearity vs Average Output Power
 OQPSK, 1.6 Msps, $I_{DS} = 285\text{ mA}$

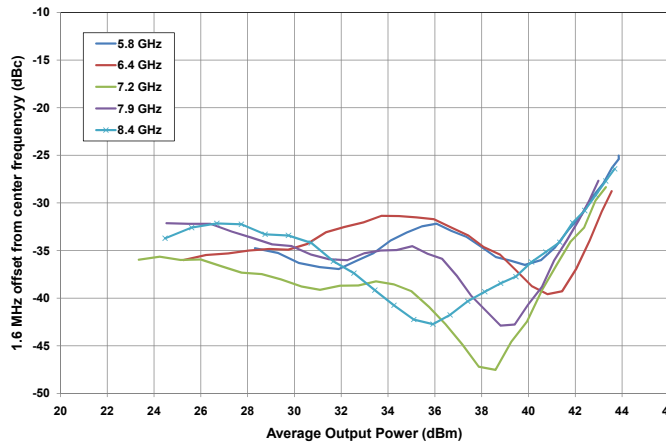
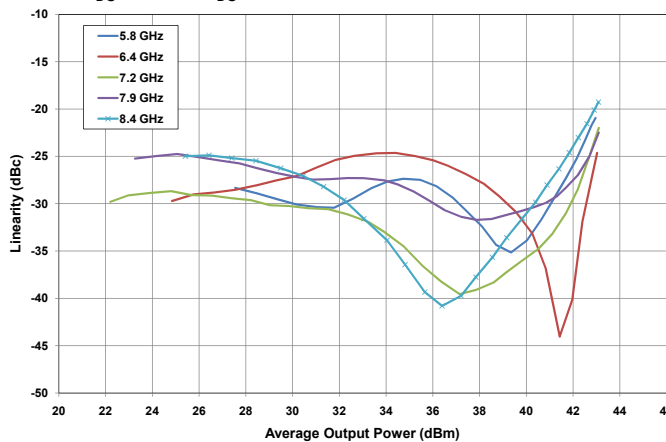

Figure 9. CMPA5585025F Linearity vs Average Output Power
 $V_{DS} = 28\text{ V}$, $I_{DS} = 285\text{ mA}$, IM3 5 MHz spacing



Typical Performance of the CMPA5585025F

Figure 10. CMPA5585025F - C-band Output Power, Gain and PAE vs Input Power
 $V_{DS} = 28\text{ V}, I_{DS} = 1.2\text{ A, CW}$

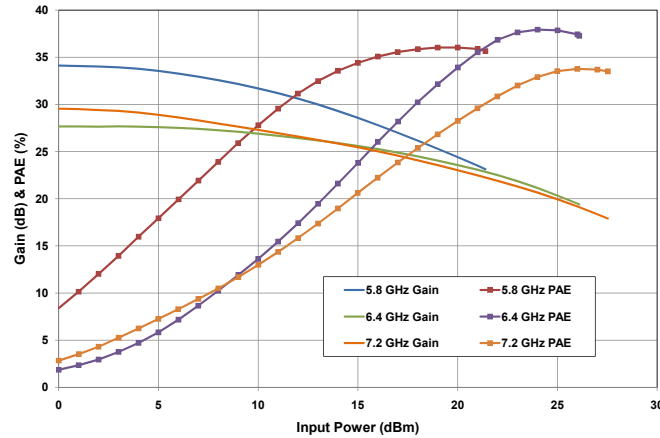

Figure 11. CMPA5585025F - X-band Output Power, Gain and PAE vs Input Power
 $V_{DS} = 28\text{ V}, I_{DS} = 1.2\text{ A, CW}$

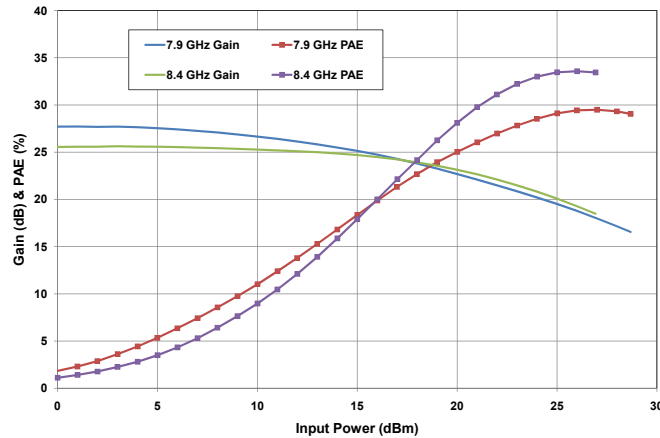
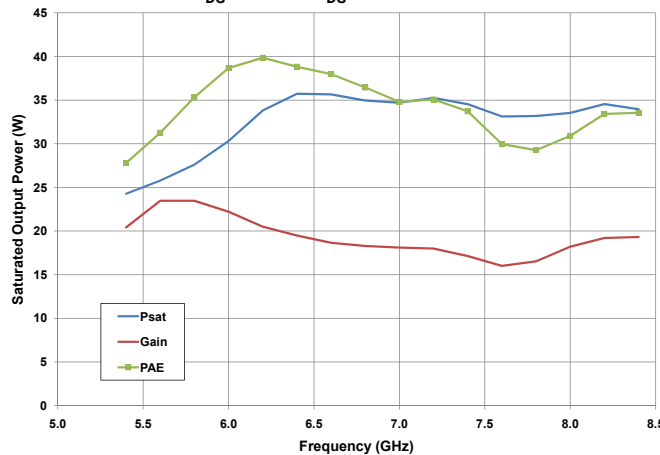

Figure 12. CMPA5585025F - Power, Gain and PAE vs Frequency
 $V_{DS} = 28\text{ V}, I_{DS} = 1.2\text{ A, CW}$



Typical Performance of the CMPA5585025F

Figure 13. CMPA5585025F - Typical Drain Current vs Average Output Power
 $V_{DS} = 28\text{ V}$, $I_{DS} = 285\text{ mA}$, OQPSK, 1.6 Msps

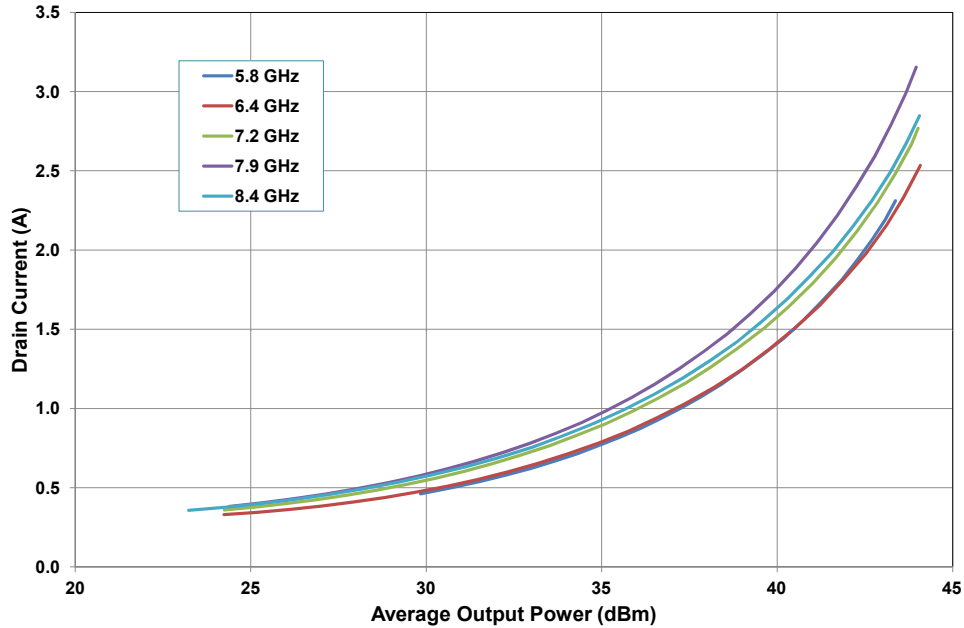
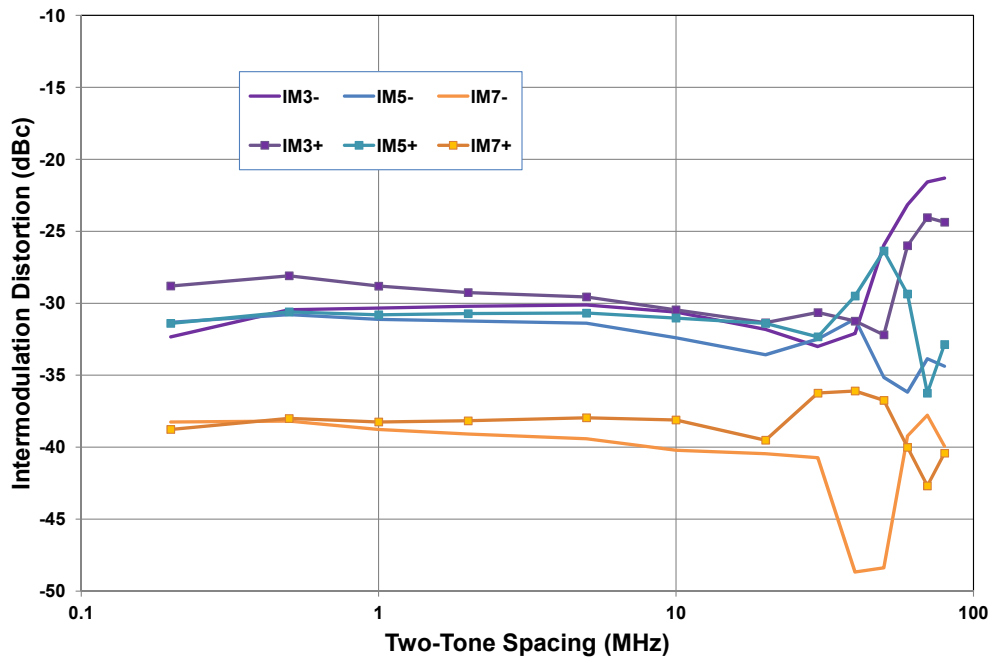

Figure 14. CMPA5585025F - Intermodulation Distortion Products vs Tone Spacing
 $V_{DS} = 28\text{ V}$, $I_{DS} = 285\text{ mA}$, Center Freq = 7.9 GHz



Note: Divergence in IM5 and IM7 at tone spacings greater than 20 MHz is due to the bias components on the test fixture.

Typical Performance of the CMPA5585025F

Figure 15. CMPA5585025F - AM-AM
 $V_{DS} = 28\text{ V}, I_{DS} = 285\text{ mA}$

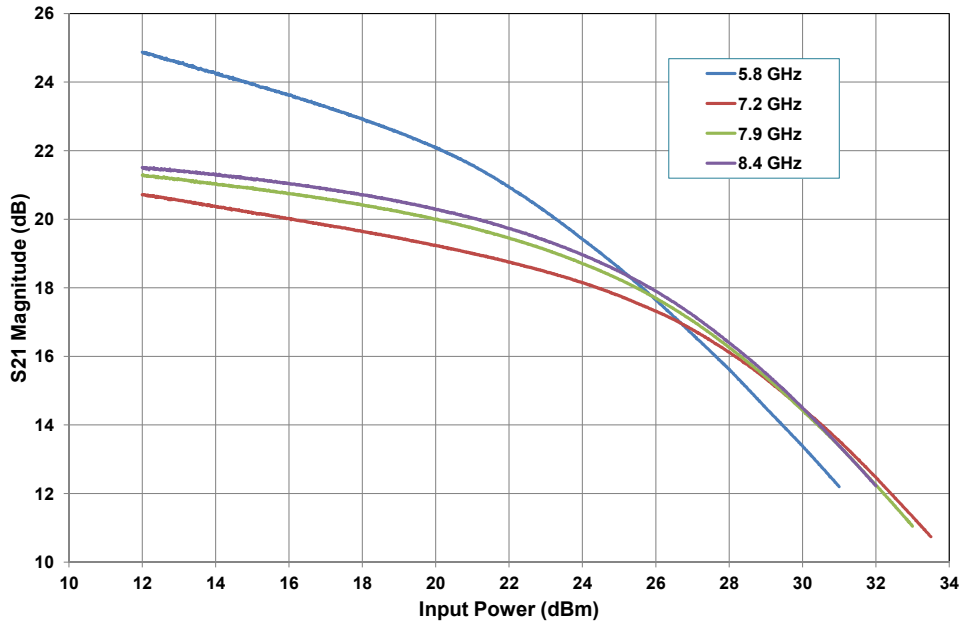
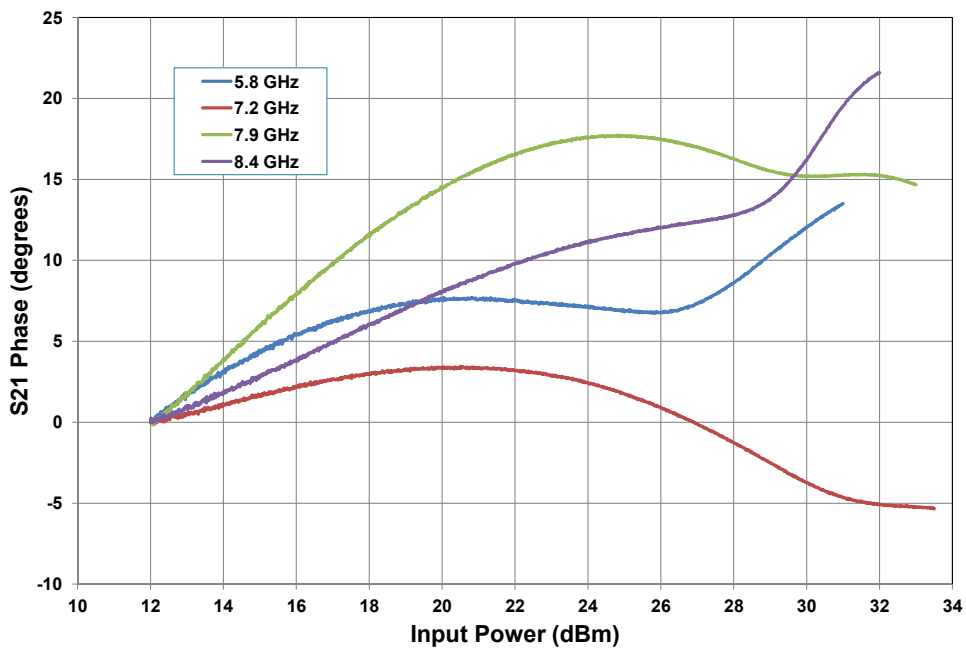

Figure 16. CMPA5585025F -Normalized AM-PM
 $V_{DS} = 28\text{ V}, I_{DS} = 285\text{ mA}$



Typical Performance of the CMPA5585025F

Figure 17. CMPA5585025F EVM vs Average Output Power
 $V_{DS} = 28\text{ V}, I_{DS} = 285\text{ mA}, 256\text{ QAM}$

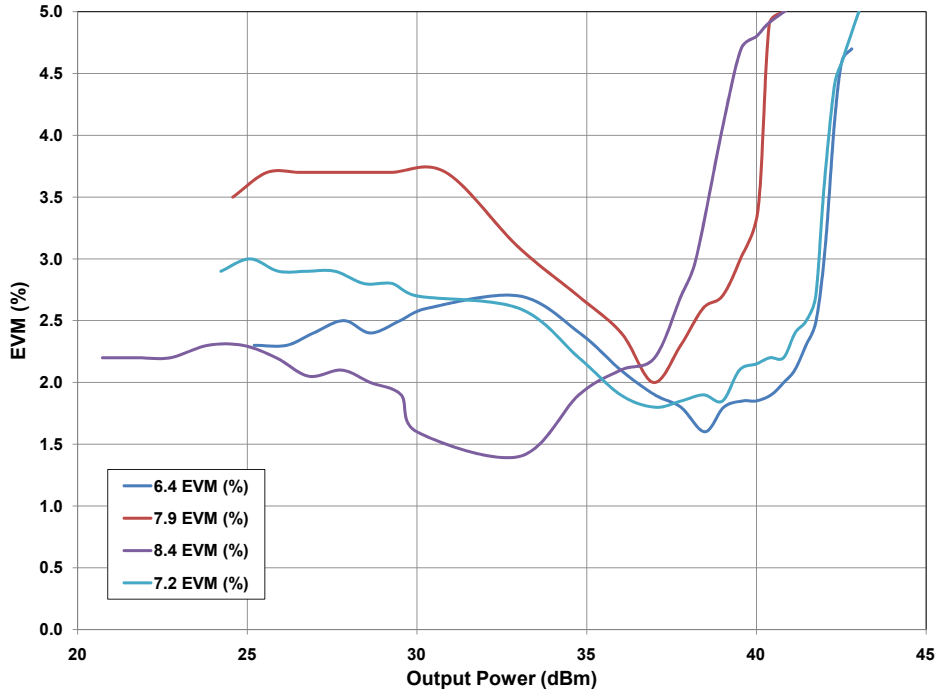
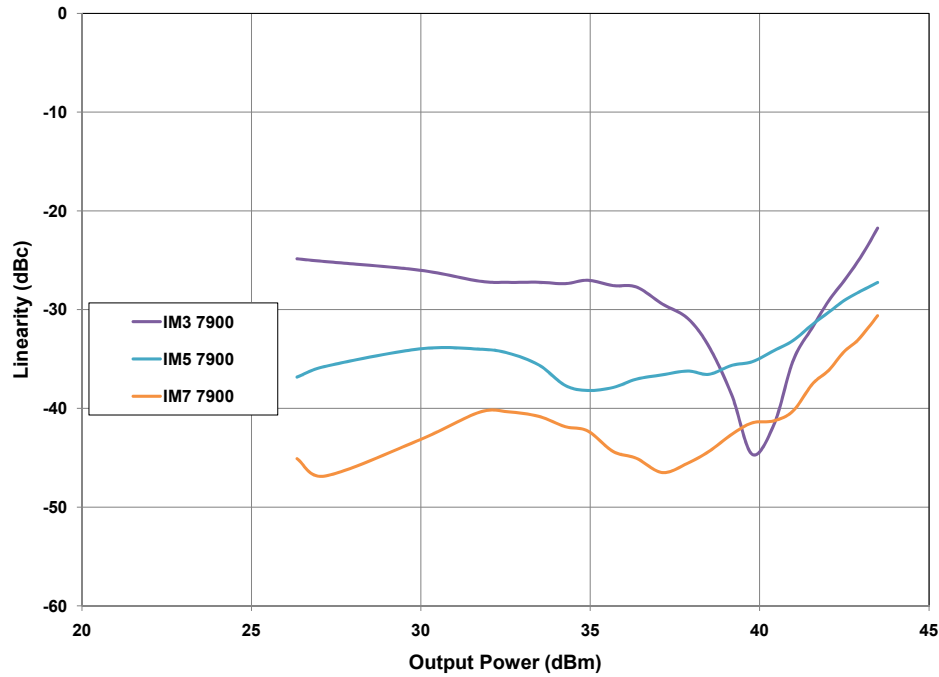
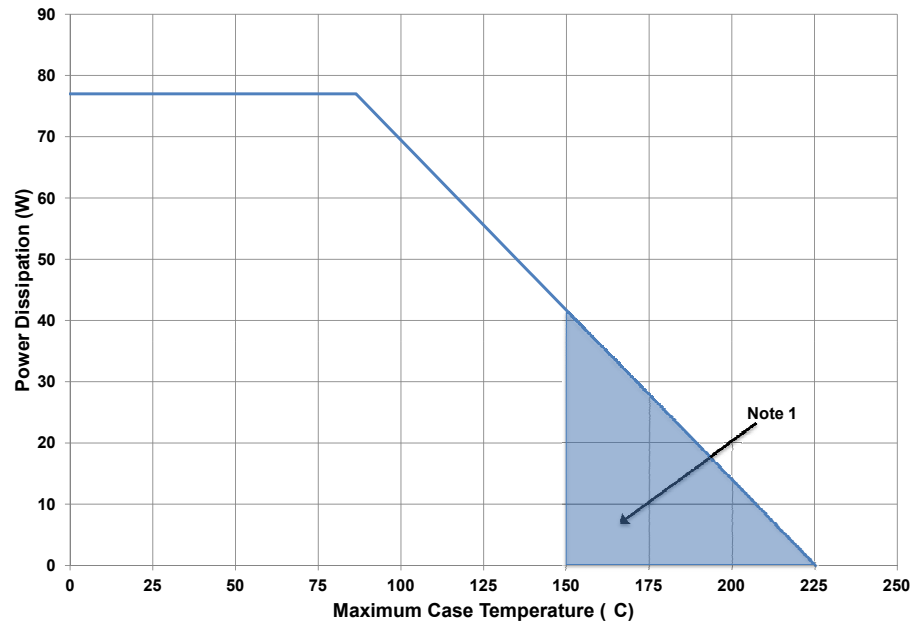

Figure 18. CMPA5585025F Linearity vs Average Output Power
 $V_{DS} = 28\text{ V}, I_{DS} = 285\text{ mA}, \text{IM3, IM5, IM7, } 5\text{ MHz spacing}$



CMPA5585025F Power Dissipation De-rating Curve



Note 1. Area exceeds Maximum Case Operating Temperature (See Page 2).

CMPA5585025F-AMP Demonstration Amplifier Circuit Bill of Materials

Designator	Description	Qty
C1, C3, C7, C8, C10, C13	CAP, 1.0 uF, +/-10%, 1210, 100V, X7R	6
C2, C4, C5, C6, C9, C12	CAP, 33000 pF, 0805, 100V, X7R	6
C11, C14	CAP ELECT 3.3UF 80V FK SMD	2
R1, R2	RES 0.0 OHM 1/16W 0402 SMD	2
J1, J2	CONN, SMA, PANEL MOUNT JACK, FLANGE, 4-HOLE, BLUNT POST, 20MIL	2
J3	CONNECTOR, HEADER, RT>PLZ .1CEN LK 9POS	1
-	PCB, TACONIC, RF-35P-0200-CL1/CL1	1
Q1	CMQA5585025F	1

CMQA5585025F-AMP Demonstration Amplifier Circuit

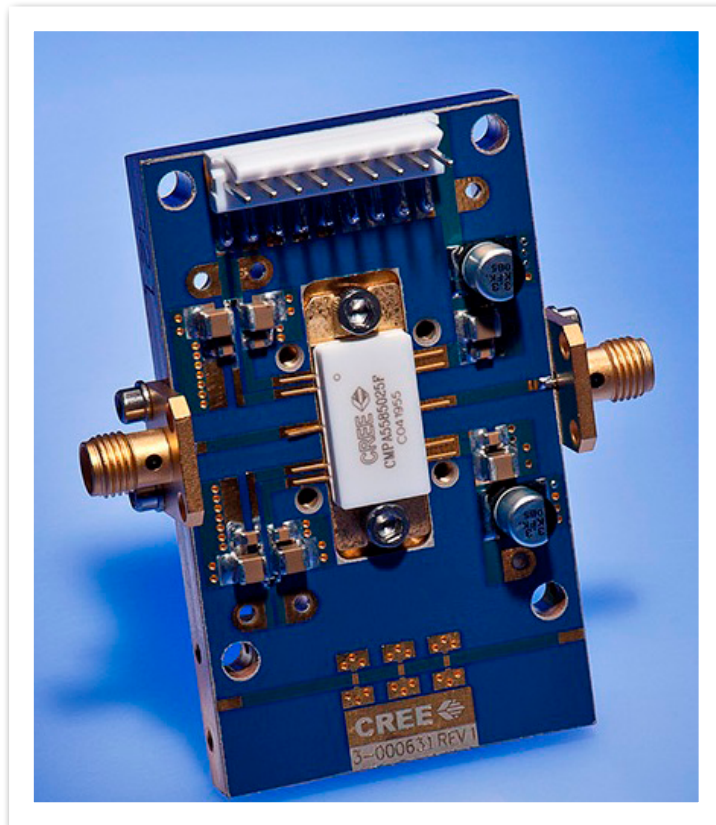

CMPA5585025F-AMP Demonstration Amplifier Circuit

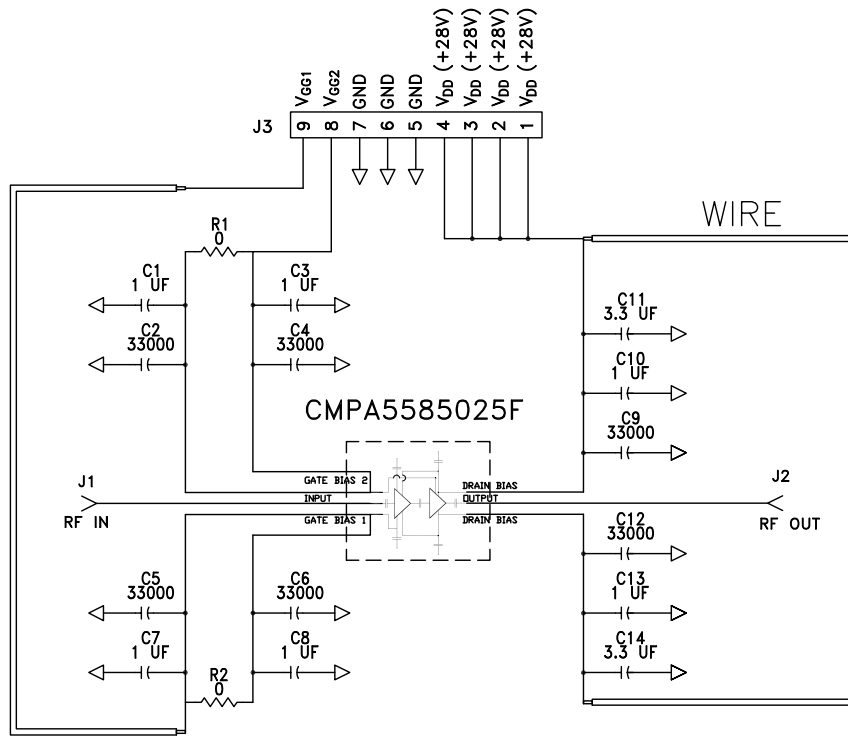

CMPA5585025F-AMP Demonstration Amplifier Circuit Outline

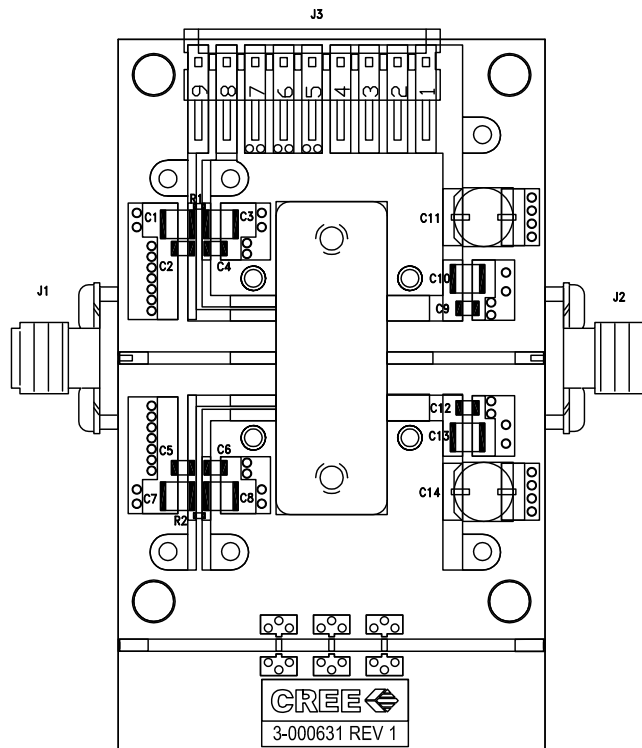

CMPA5585025F-AMP Demonstration Amplifier Circuit

To configure the CMA5585025F test fixture to enable independent V_{G1} / V_{G2} control of the device, a cut must be made to the microstrip line just above the R1 resistor as shown. Pin 9 will then supply V_{G1} and Pin 8 will supply V_{G2} .

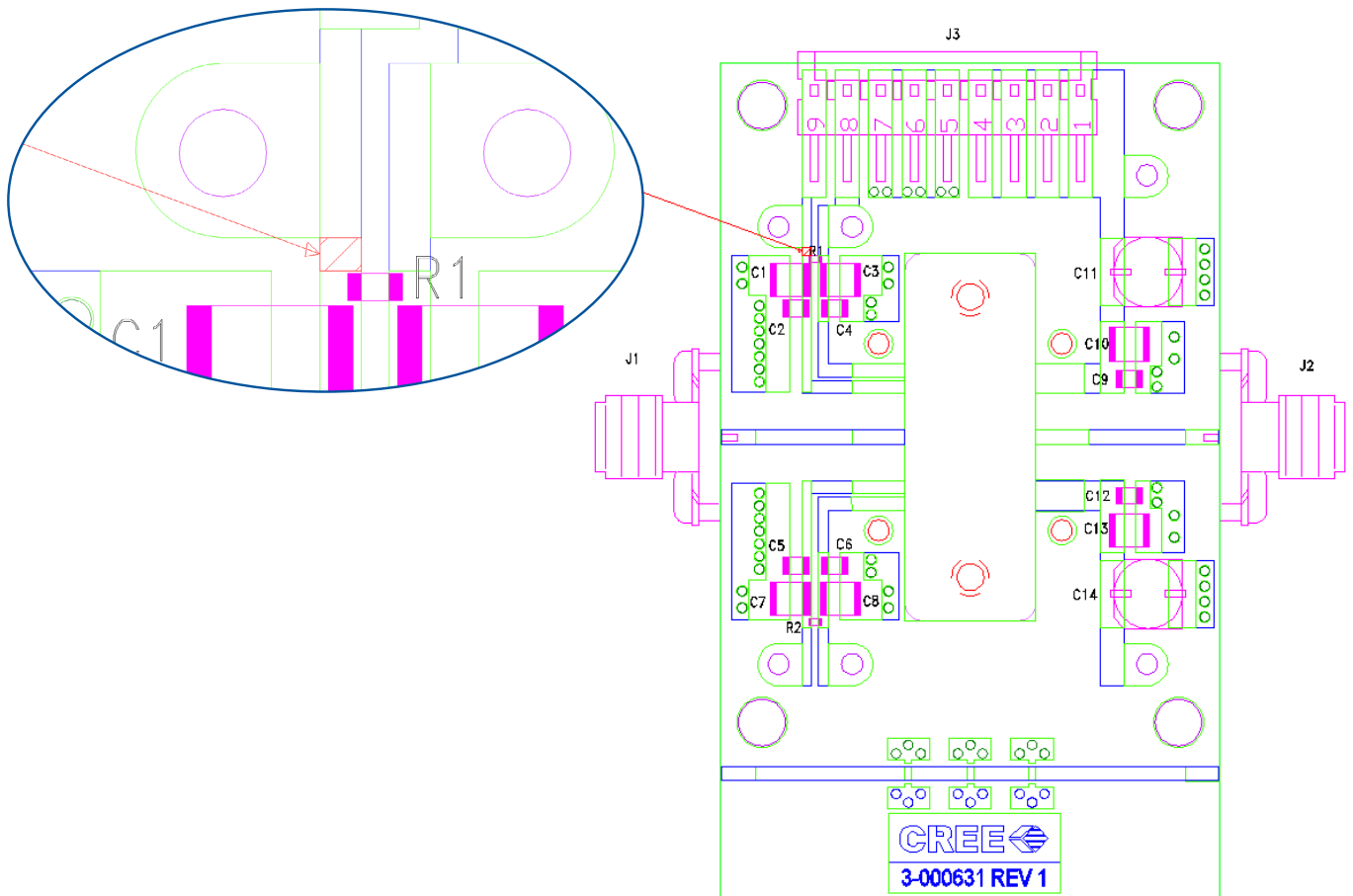

Product Dimensions CMPA5585025F (Package Type – 440213)

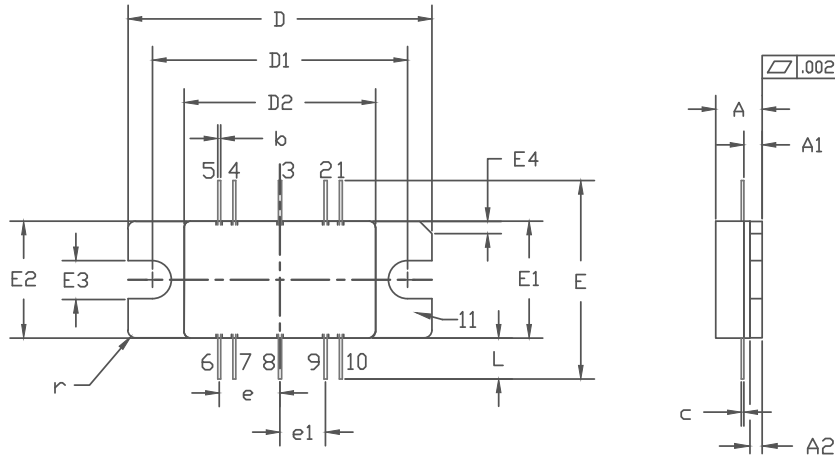

PIN 1: GATE BIAS 6: DRAIN BIAS
 2: GATE BIAS 7: DRAIN BIAS
 3: RF IN 8: RF OUT
 4: GATE BIAS 9: DRAIN BIAS
 5: GATE BIAS 10: DRAIN BIAS
 11: SOURCE

NOTES:

1. DIMENSIONING AND TOLERANCING PER ANSI Y14.5M - 1994.
2. CONTROLLING DIMENSION: INCH.
3. ADHESIVE FROM LID MAY EXTEND A MAXIMUM OF 0.020" BEYOND EDGE OF LID.
4. LID MAY BE MISALIGNED TO THE BODY OF PACKAGE BY A MAXIMUM OF 0.008" IN ANY DIRECTION.

DIM	INCHES		MILLIMETERS		NOTES
	MIN	MAX	MIN	MAX	
A	0.148	0.168	3.76	4.27	
A1	0.055	0.065	1.40	1.65	
A2	0.035	0.045	0.89	1.14	
b	0.01 TYP		0.254 TYP		10x
c	0.007	0.009	0.18	0.23	
D	0.995	1.005	25.27	25.53	
D1	0.835	0.845	21.21	21.46	
D2	0.623	0.637	15.82	16.18	
E	0.653 TYP		16.59 TYP		
E1	0.380	0.390	9.65	9.91	
E2	0.380	0.390	9.65	9.91	
E3	0.120	0.130	3.05	3.30	
E4	0.035	0.045	0.89	1.14	45° CHAMFER
e	0.200 TYP		5.08 TYP		4x
e1	0.150 TYP		3.81 TYP		4x
L	0.115	0.155	2.92	3.94	10x
r	0.025 TYP		.635 TYP		3x

Pin Number	Qty
1	Gate Bias for Stage 2
2	Gate Bias for Stage 2
3	RF In
4	Gate Bias for Stage 1
5	Gate Bias for Stage 1
6	Drain Bias
7	Drain Bias
8	RF Out
9	Drain Bias
10	Drain Bias
11	Source

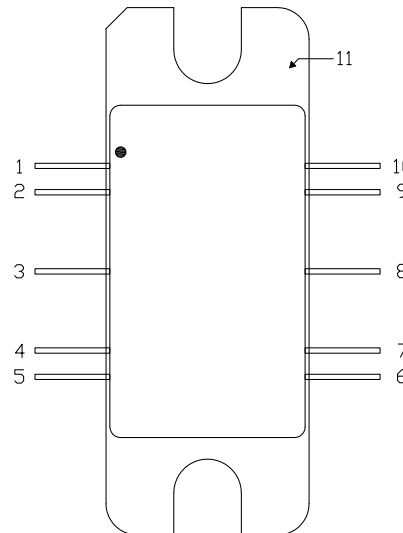

CMPA5585025F

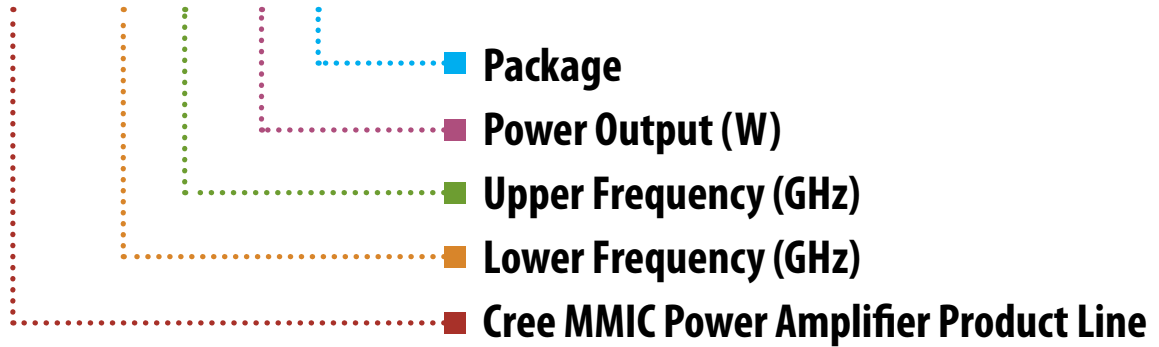

Parameter	Value	Units
Lower Frequency	5.5	GHz
Upper Frequency ¹	8.5	GHz
Power Output	25	W
Package	Flange	-

Table 1.

Note¹: Alpha characters used in frequency code indicate a value greater than 9.9 GHz. See Table 2 for value.

Character Code	Code Value
A	0
B	1
C	2
D	3
E	4
F	5
G	6
H	7
J	8
K	9
Examples:	1A = 10.0 GHz 2H = 27.0 GHz

Table 2.

Product Ordering Information

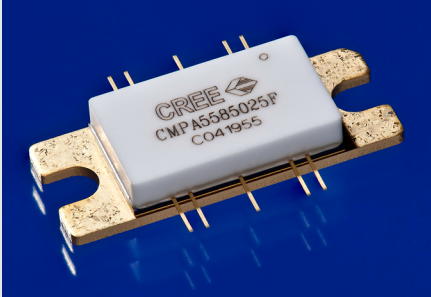
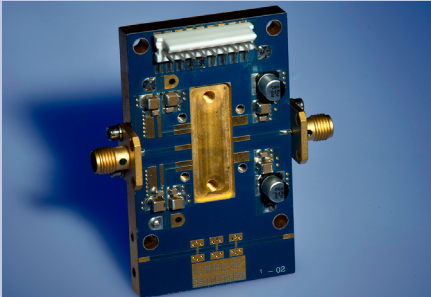
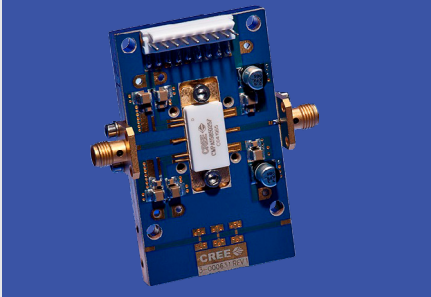
Order Number	Description	Unit of Measure	Image
CMPA5585025F	GaN MMIC	Each	
CMPA5585025F-TB	Test board without GaN MMIC	Each	
CMPA5585025F-AMP	Test board with GaN MMIC installed	Each	



Disclaimer

Specifications are subject to change without notice. Cree, Inc. believes the information contained within this data sheet to be accurate and reliable. However, no responsibility is assumed by Cree for its use or for any infringement of patents or other rights of third parties which may result from its use. No license is granted by implication or otherwise under any patent or patent rights of Cree. Cree makes no warranty, representation or guarantee regarding the suitability of its products for any particular purpose. "Typical" parameters are the average values expected by Cree in large quantities and are provided for information purposes only. These values can and do vary in different applications, and actual performance can vary over time. All operating parameters should be validated by customer's technical experts for each application. Cree products are not designed, intended, or authorized for use as components in applications intended for surgical implant into the body or to support or sustain life, in applications in which the failure of the Cree product could result in personal injury or death, or in applications for the planning, construction, maintenance or direct operation of a nuclear facility. CREE and the CREE logo are registered trademarks of Cree, Inc.

For more information, please contact:

Cree, Inc.
4600 Silicon Drive
Durham, North Carolina, USA 27703
www.cree.com/RF

Sarah Miller
Marketing
Cree, RF Components
1.919.407.5302

Ryan Baker
Marketing & Sales
Cree, RF Components
1.919.407.7816

Tom Dekker
Sales Director
Cree, RF Components
1.919.407.5639

Mouser Electronics

Authorized Distributor

Click to View Pricing, Inventory, Delivery & Lifecycle Information:

[Cree, Inc.:](#)

[CMPA5585025F](#) [CMPA5585025F-TB](#)