

## Description

The PAM2312 is a step-down current-mode, DC-DC converter. At heavy load, the constant frequency PWM control performs excellent stability and transient response. To ensure the longest battery life in portable applications, the PAM2312 provides a power-saving Pulse-Skipping Modulation (PSM) mode to reduce quiescent current under light load operation to save power.

The PAM2312 supports a range of input voltages from 2.5V to 5.5V, allowing the use of a single Li+/Li-polymer cell, multiple Alkaline/NiMH cell, USB, and other standard power sources. The output voltage is adjustable from 0.6V to the input voltage. All versions employ internal power switch and synchronous rectifier to minimize external part count and realize high efficiency. During shutdown, the input is disconnected from the output and the shutdown current is less than 1 $\mu$ A. Other key features include under-voltage lockout to prevent deep battery discharge.

The PAM2312 is available in TSOT25 packages.

## Features

- Efficiency up to 96%
- Only 40 $\mu$ A (typ.) Quiescent Current
- Output Current: Up to 1A
- Internal Synchronous Rectifier
- 1.5MHz Switching Frequency
- Soft Start
- Under-Voltage Lockout
- Short Circuit Protection
- Thermal Shutdown
- TSOT25 Packages
- **Totally Lead-Free & Fully RoHS Compliant (Notes 1 & 2)**
- **Halogen and Antimony Free. "Green" Device (Note 3)**

- Notes:
1. No purposely added lead. Fully EU Directive 2002/95/EC (RoHS), 2011/65/EU (RoHS 2) & 2015/863/EU (RoHS 3) compliant.
  2. See <https://www.diodes.com/quality/lead-free/> for more information about Diodes Incorporated's definitions of Halogen- and Antimony-free, "Green" and Lead-free.
  3. Halogen- and Antimony-free "Green" products are defined as those which contain <900ppm bromine, <900ppm chlorine (<1500ppm total Br + Cl) and <1000ppm antimony compounds.

## Pin Assignments

Top View

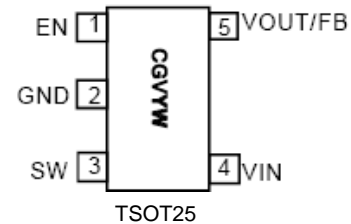

## Applications

- Cellular Phone
- Portable Electronics
- Wireless Devices
- Cordless Phone
- Computer Peripherals
- Battery Powered Widgets
- Electronic Scales
- Digital Frame

**Typical Applications Circuit**

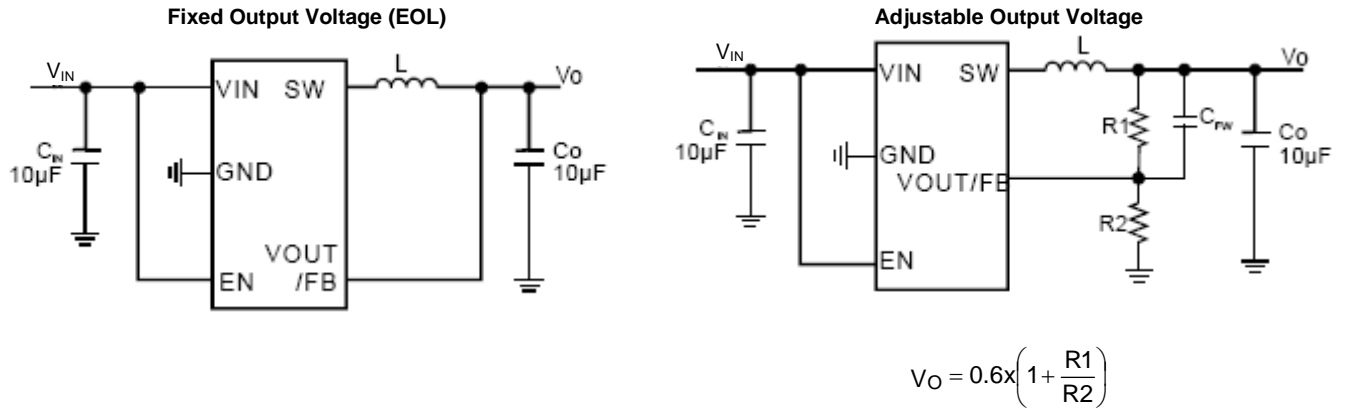

**Pin Descriptions**

| Pin Number | TSOT25 Pin Name | Function   |
|------------|-----------------|--|
| 4          | VIN             | Chip Main Power Supply Pin   |
| 2          | GND             | Ground   |
| 1          | EN              | Enable Control Input. Force this pin voltage above 1.5V, enables the chip, and below 0.3V shuts down the device.   |
| 5          | VOUT/FB         | VOUT: Output voltage feedback pin, an internal resistive divider divides the output voltage down for comparison to the internal reference voltage.<br>FB: Feedback voltage to internal error amplifier, the threshold voltage is 0.6V. |
| 3          | SW              | The drains of the internal main and synchronous power MOSFET.  |

**Functional Block Diagram**

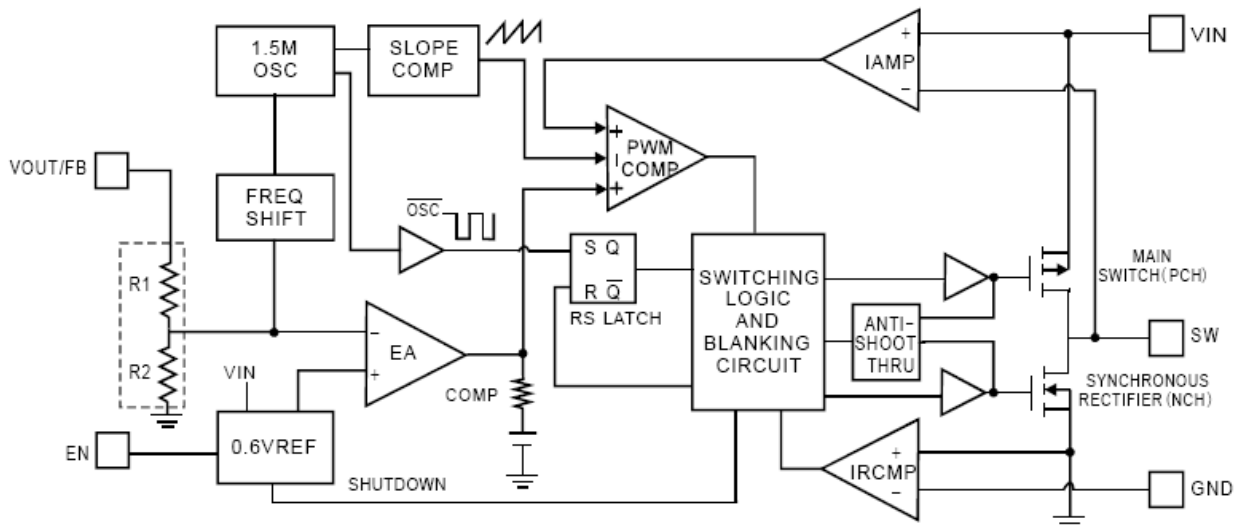

### Absolute Maximum Ratings (@T<sub>A</sub> = +25°C, unless otherwise specified.)

These are stress ratings only and functional operation is not implied. Exposure to absolute maximum ratings for prolonged time periods may affect device reliability. All voltages are with respect to ground.

| Parameter                 | Rating                         | Unit |
|---------------------------|--------------------------------|------|
| Input Voltage             | -0.3 to +6.0                   | V    |
| EN, FB Pin Voltage        | -0.3 to V <sub>IN</sub>        | V    |
| SW Pin Voltage            | -0.3 to (V <sub>IN</sub> +0.3) | V    |
| Junction Temperature      | +150                           | °C   |
| Storage Temperature Range | -65 to +150                    | °C   |
| Soldering Temperature     | +300, 5s                       | °C   |

### Recommended Operating Conditions (@T<sub>A</sub> = +25°C, unless otherwise specified.)

| Parameter                   | Rating      | Unit |
|-----------------------------|-------------|------|
| Supply Voltage              | 2.5 to 5.5  | V    |
| Operation Temperature Range | -40 to +85  | °C   |
| Junction Temperature Range  | -40 to +125 |      |

### Thermal Information

| Symbol          | Parameter                                | Package         | Max | Unit |
|-----------------|--|-----------------|-----|------|
| θ <sub>JC</sub> | Thermal Resistance (Junction to Case)    | TSOT25 (Note 4) | 130 | °C/W |
| θ <sub>JA</sub> | Thermal Resistance (Junction to Ambient) | TSOT25          | 250 |      |
| P <sub>D</sub>  | Internal Power Dissipation               | TSOT25          | 400 | mW   |

Note: 4. The maximum output current for TSOT25 package is limited by internal power dissipation capacity as described in Application Information herein after.

**Electrical Characteristics** (@ $T_A = +25^\circ\text{C}$ ,  $V_{IN} = 3.6\text{V}$ ,  $V_O = 1.8\text{V}$ ,  $C_{IN} = 10\mu\text{F}$ ,  $C_{OUT} = 10\mu\text{F}$ ,  $L = 4.7\mu\text{H}$ , unless otherwise specified.)

| Symbol          | Parameter                         | Test Conditions   | Min      | Typ        | Max   | Unit             |          |
|-----------------|-----------------------------------|---|----------|------------|-------|------------------|----------|
| $V_{IN}$        | Input Voltage Range               | -   | 2.5      | -          | 5.5   | V                |          |
| $V_{FB}$        | Regulated Feedback Voltage        | -   | 0.588    | 0.6        | 0.612 | V                |          |
| $\Delta V_{FB}$ | Reference Voltage Line Regulation | -   | -        | 0.3        | -     | %/V              |          |
| $V_O$           | Regulated Output Voltage Accuracy | $I_O = 100\text{mA}$  | -3       | -          | +3    | %                |          |
| $I_{PK}$        | Peak Inductor Current             | $V_{IN} = 3\text{V}$ , $V_{FB} = 0.5\text{V}$ or $V_O = 90\%$ | -        | 1.5        | -     | A                |          |
| LNR             | Output Voltage Line Regulation    | $V_{IN} = 2.5\text{V}$ to $5\text{V}$ , $I_O = 10\text{mA}$   | -        | 0.2        | 0.5   | %/V              |          |
| LDR             | Output Voltage Load Regulation    | $I_O = 800\text{mA}$  | -        | 0.5        | 1.5   | %                |          |
| $I_Q$           | Quiescent Current                 | No Load   | -        | 40         | 70    | $\mu\text{A}$    |          |
| $I_{SD}$        | Shutdown Current                  | $V_{EN} = 0\text{V}$  | -        | -          | 1     | $\mu\text{A}$    |          |
| $f_{OSC}$       | Oscillator Frequency              | $V_O = 100\%$   | 1.2      | 1.5        | 1.8   | MHz              |          |
|                 |                                   | $V_{FB} = 0\text{V}$ or $V_O = 0\text{V}$                     | -        | 500        | -     | kHz              |          |
| $R_{DS(ON)}$    | Drain-Source On-State Resistance  | $I_{DS} = 100\text{mA}$                                       | P MOSFET | -          | 0.3   | 0.45             | $\Omega$ |
|                 |                                   |   | N MOSFET | -          | 0.35  | 0.5              | $\Omega$ |
| $I_{LSW}$       | SW Leakage Current                | -   | -        | $\pm 0.01$ | 1     | $\mu\text{A}$    |          |
| $\eta$          | High Efficiency                   | -   | -        | 96         | -     | %                |          |
| $V_{EH}$        | EN Threshold High                 | -   | 1.5      | -          | -     | V                |          |
| $V_{EL}$        | EN Threshold Low                  | -   | -        | -          | 0.3   | V                |          |
| $I_{EN}$        | EN Leakage Current                | -   | -        | $\pm 0.01$ | -     | $\mu\text{A}$    |          |
| OTP             | Over Temperature Protection       | -   | -        | +150       | -     | $^\circ\text{C}$ |          |
| OTH             | OTP Hysteresis                    | -   | -        | +30        | -     | $^\circ\text{C}$ |          |

**Typical Performance Characteristics** (@ $T_A = +25^\circ\text{C}$ ,  $C_{IN} = 10\mu\text{F}$ ,  $C_O = 10\mu\text{F}$ ,  $L = 4.7\mu\text{H}$ , unless otherwise specified.)

NEW PRODUCT

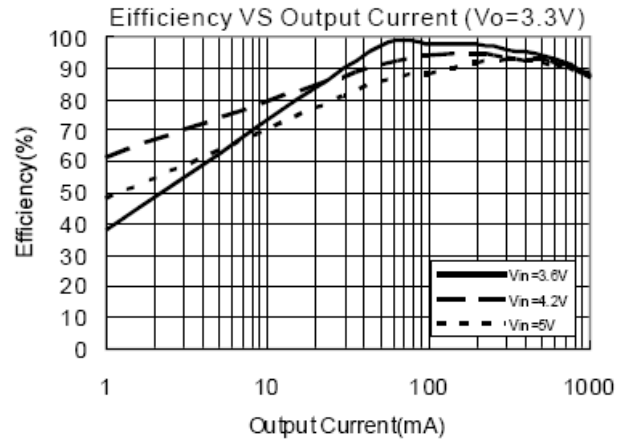
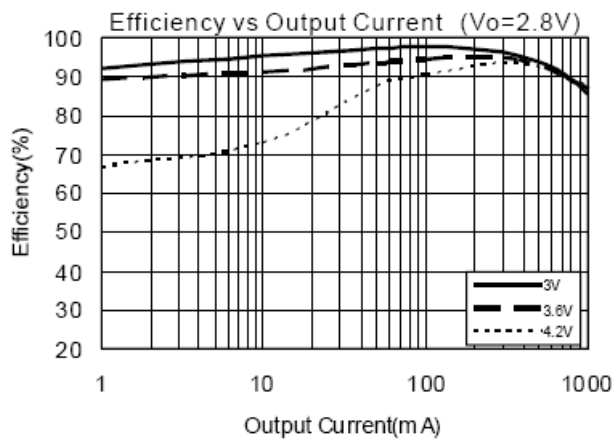
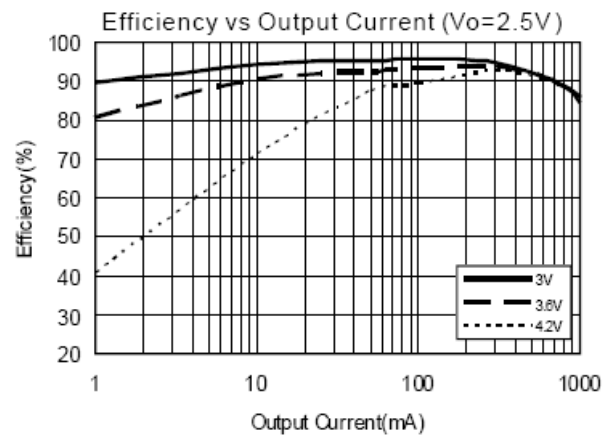
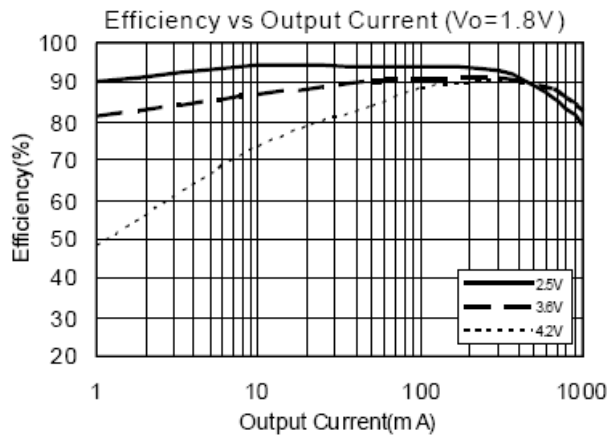
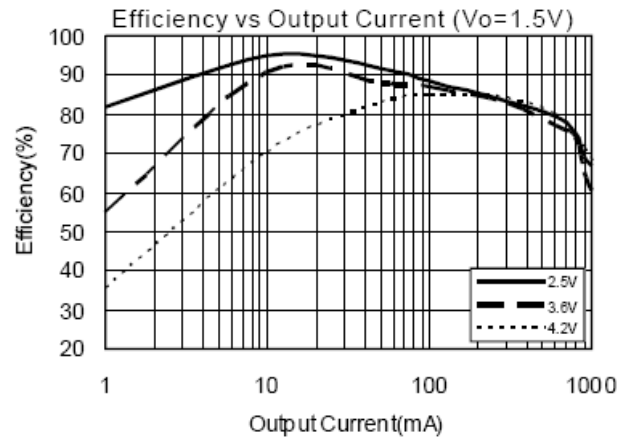
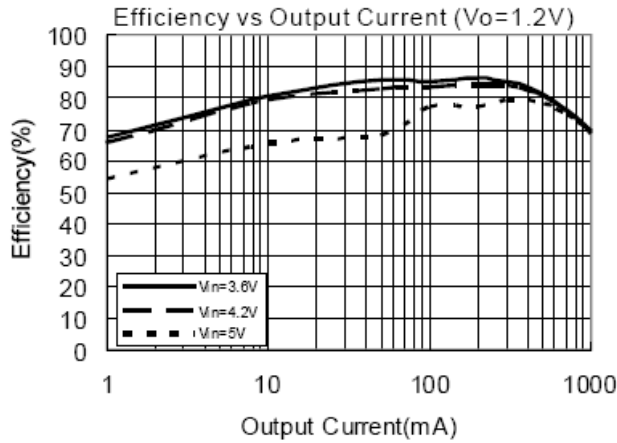

**Typical Performance Characteristics** (Cont.) (@ $T_A = +25^\circ\text{C}$ ,  $C_{IN} = 10\mu\text{F}$ ,  $C_O = 10\mu\text{F}$ ,  $L = 4.7\mu\text{H}$ , unless otherwise specified.)

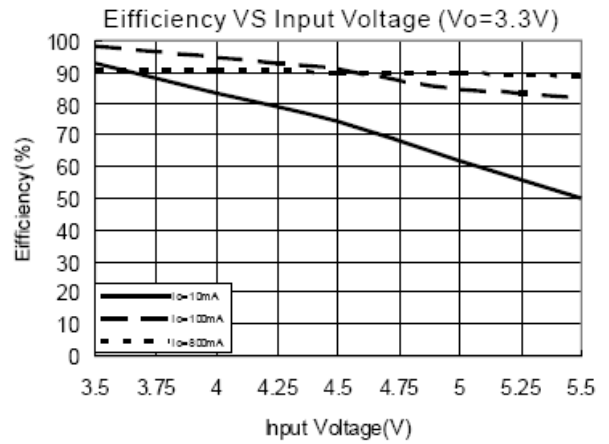
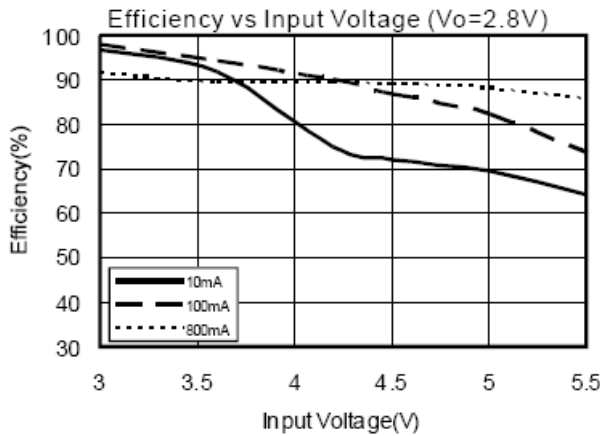
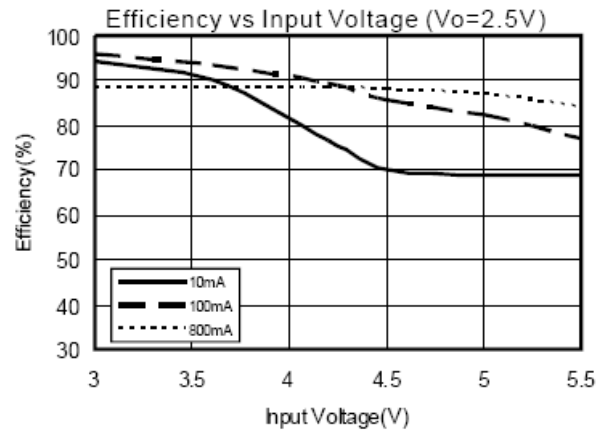
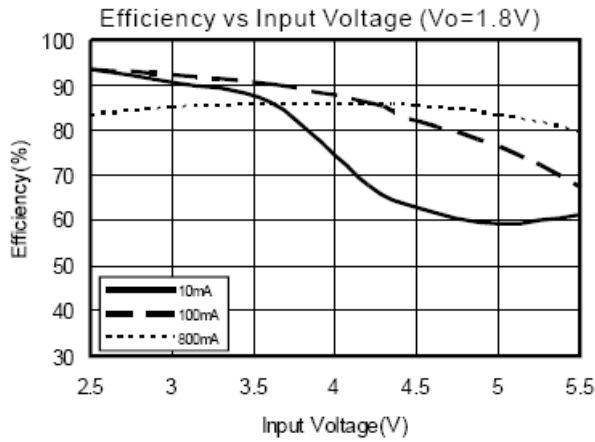
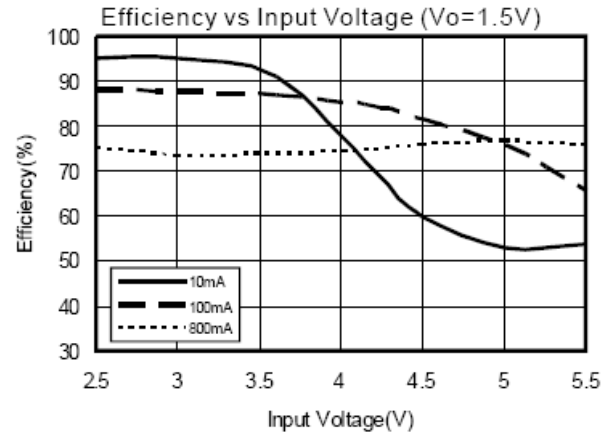
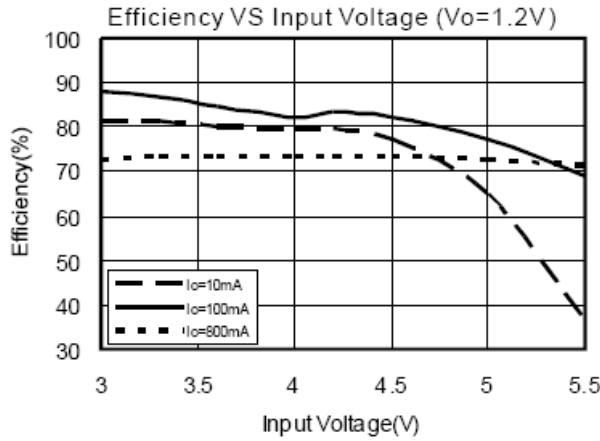

**Typical Performance Characteristics** (Cont.) (@ $T_A = +25^\circ\text{C}$ ,  $C_{IN} = 10\mu\text{F}$ ,  $C_O = 10\mu\text{F}$ ,  $L = 4.7\mu\text{H}$ , unless otherwise specified.)

NEW PRODUCT

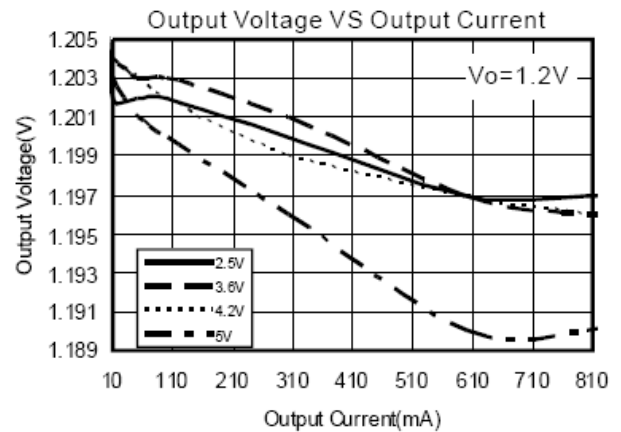
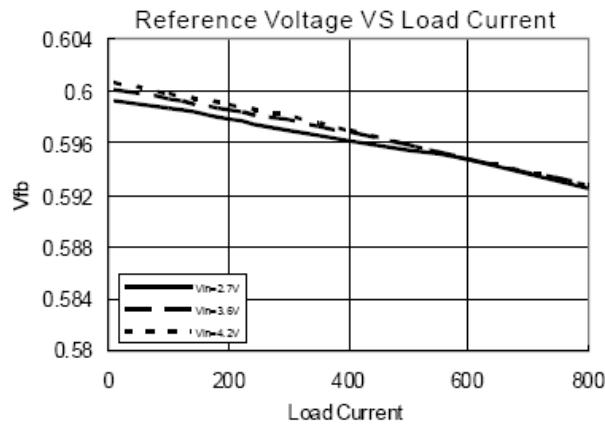
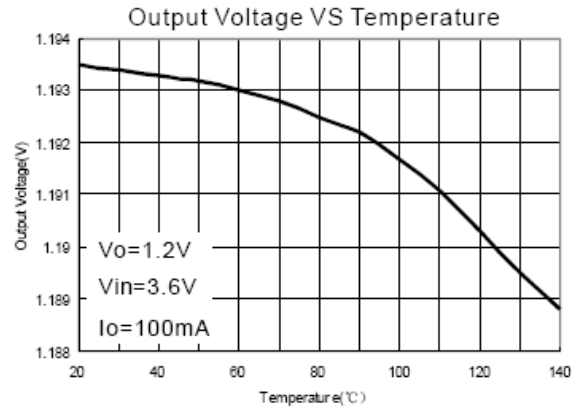
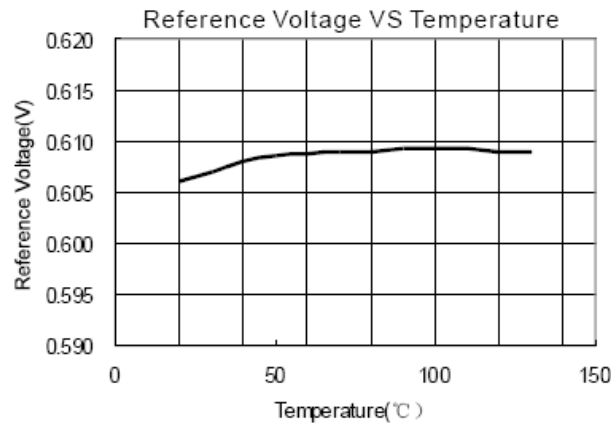
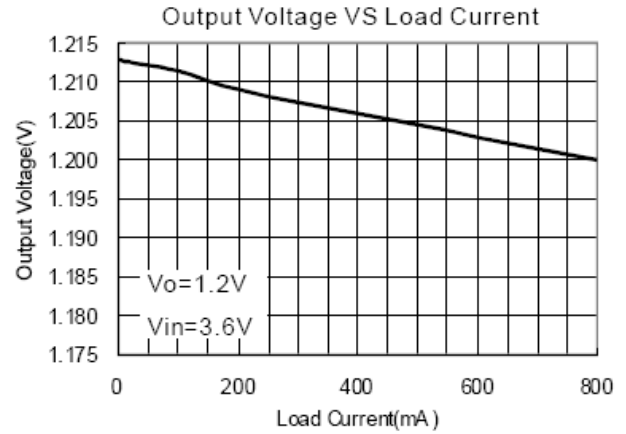
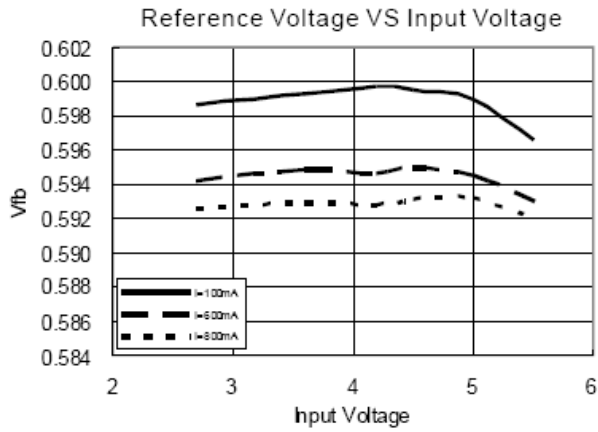

**Typical Performance Characteristics** (Cont.) (@ $T_A = +25^\circ\text{C}$ ,  $C_{IN} = 10\mu\text{F}$ ,  $C_O = 10\mu\text{F}$ ,  $L = 4.7\mu\text{H}$ , unless otherwise specified.)

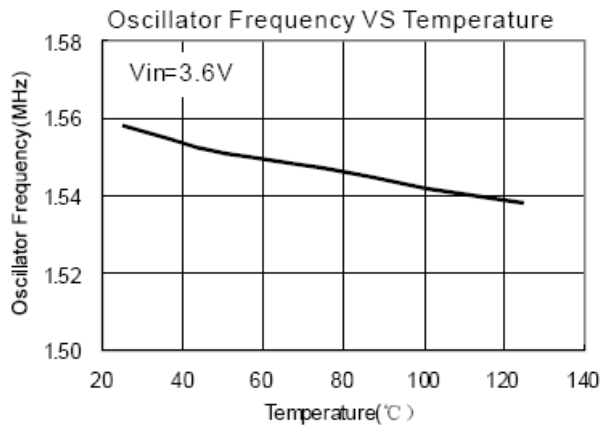
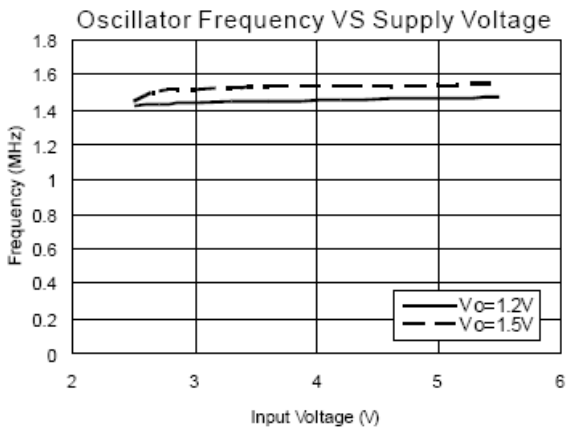
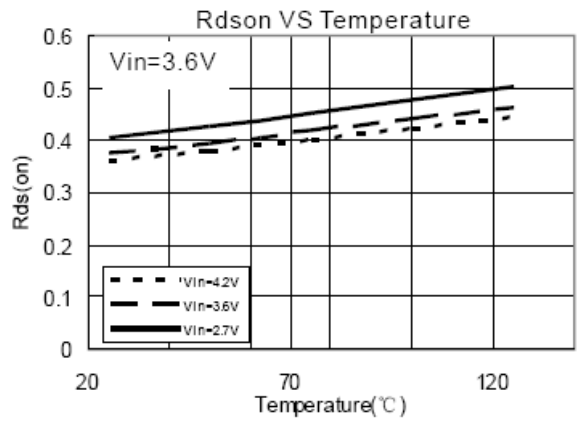
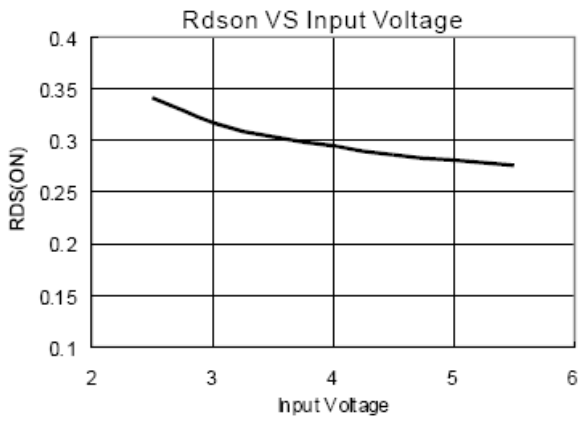
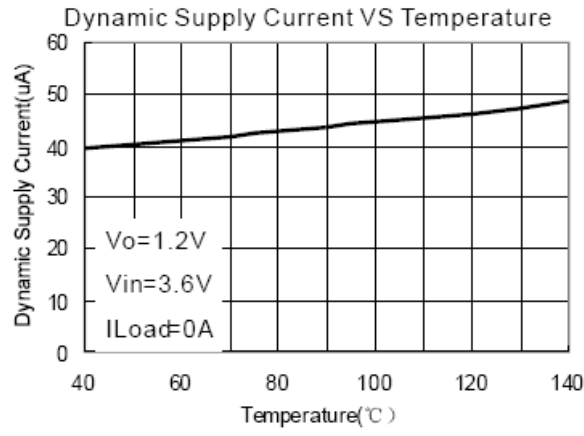
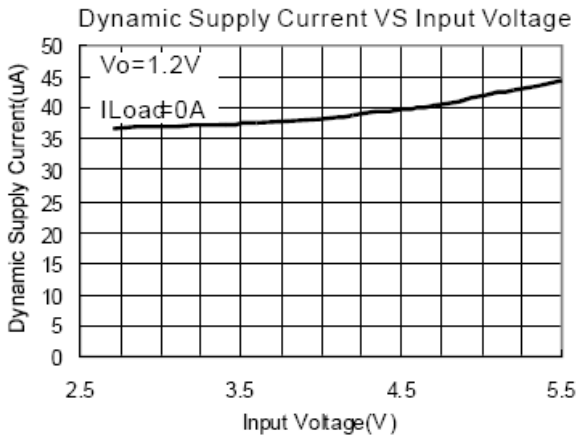



**Typical Performance Characteristics** (Cont.) (@ $T_A = +25^\circ\text{C}$ ,  $C_{IN} = 10\mu\text{F}$ ,  $C_O = 10\mu\text{F}$ ,  $L = 4.7\mu\text{H}$ , unless otherwise specified.)

Load Transient  
 $I_o=0-500\text{mA}$ ,  $V_o=3.3\text{V}$ ,  $V_{in}=5\text{V}$

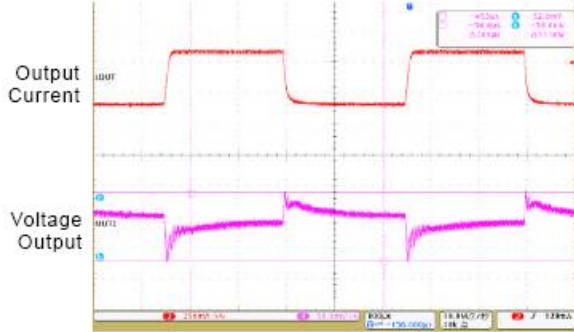

Load Transient  
 $I_o=0-1\text{A}$ ,  $V_o=1.2\text{V}$ ,  $V_{in}=3.6\text{V}$

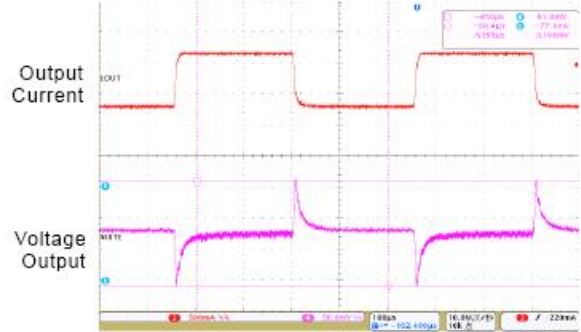

Start-up from Shutdown  
 $V_o=1.8\text{V}$ ,  $V_{in}=3.6\text{V}$

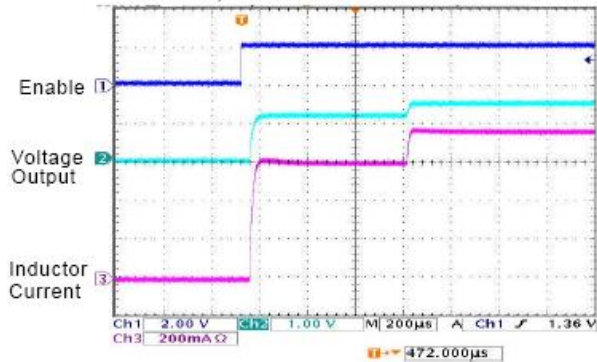

## Application Information

The basic PAM2312 application circuit is shown in Page 1. External component selection is determined by the load requirement, selecting L first and then C<sub>IN</sub> and C<sub>OUT</sub>.

### Inductor Selection

For most applications, the value of the inductor will fall in the range of 1μH to 4.7μH. Its value is chosen based on the desired ripple current. Large value inductors lower ripple current and small value inductors result in higher ripple currents. Higher V<sub>IN</sub> or V<sub>OUT</sub> also increases the ripple current as shown in Equation 1. A reasonable starting point for setting ripple current is ΔI<sub>L</sub> = 400mA (40% of 1A).

$$\Delta I_L = \frac{1}{f(L)} V_{OUT} \left( 1 - \frac{V_{OUT}}{V_{IN}} \right) \quad \text{Equation (1)}$$

The DC current rating of the inductor should be at least equal to the maximum load current plus half the ripple current to prevent core saturation. Thus, a 1.4A rated inductor should be enough for most applications (1A + 400mA). For better efficiency, choose a low DC-resistance inductor.

|                |       |       |       |       |       |
|----------------|-------|-------|-------|-------|-------|
| V <sub>O</sub> | 1.2V  | 1.5V  | 1.8V  | 2.5V  | 3.3V  |
| L              | 2.2μH | 2.2μH | 4.7μH | 4.7μH | 4.7μH |

### C<sub>IN</sub> and C<sub>OUT</sub> Selection

In continuous mode, the source current of the top MOSFET is a square wave of duty cycle V<sub>OUT</sub>/V<sub>IN</sub>. To prevent large voltage transients, a low ESR input capacitor sized for the maximum RMS current must be used. The maximum RMS capacitor current is given by:

$$C_{IN \text{ required}} I_{RMS} \cong I_{OMAX} \frac{[V_{OUT}(V_{IN} - V_{OUT})]^{1/2}}{V_{IN}}$$

This formula has a maximum at V<sub>IN</sub> = 2V<sub>OUT</sub>, where I<sub>RMS</sub> = I<sub>OUT</sub>/2. This simple worst-case condition is commonly used for design because even significant deviations do not offer much relief. Note that the capacitor manufacturer's ripple current ratings are often based on 2000 hours of life. This makes it advisable to further derate the capacitor, or choose a capacitor rated at a higher temperature than required. Consult the manufacturer if there is any question.

The selection of C<sub>OUT</sub> is driven by the required effective series resistance (ESR).

Typically, once the ESR requirement for C<sub>OUT</sub> has been met, the RMS current rating generally far exceeds the I<sub>RIPPLE</sub> (P-P) requirement. The output ripple ΔV<sub>OUT</sub> is determined by:

$$\Delta V_{OUT} \approx \Delta I_L \left( ESR + \frac{1}{8f C_{OUT}} \right)$$

Where f = operating frequency, C<sub>OUT</sub> = output capacitance and ΔI<sub>L</sub> = ripple current in the inductor. For a fixed output voltage, the output ripple is highest at maximum input voltage since ΔI<sub>L</sub> increases with input voltage.

### Using Ceramic Input and Output Capacitors

Higher values, lower cost ceramic capacitors are now becoming available in smaller case sizes. Their high ripple current, high voltage rating and low ESR make them ideal for switching regulator applications. Using ceramic capacitors can achieve very low output ripple and small circuit size.

When choosing the input and output ceramic capacitors, choose the X5R or X7R dielectric formulations. These dielectrics have the best temperature and voltage characteristics of all the ceramics for a given value and size.

### Thermal Consideration

Thermal protection limits power dissipation in the PAM2312. When the junction temperature exceeds +150°C, the OTP (Over Temperature Protection) starts the thermal shutdown and turns the pass transistor off. The pass transistor resumes operation after the junction temperature drops below +120°C.

For continuous operation, the junction temperature should be maintained below +125°C. The power dissipation is defined as:

$$P_D = I_O^2 \frac{V_O R_{DS(ON)H} + (V_{IN} - V_O) R_{DS(ON)L}}{V_{IN}} + (t_{SW} F_s I_O + I_Q) V_{IN}$$

I<sub>Q</sub> is the step-down converter quiescent current. The term t<sub>sw</sub> is used to estimate the full load step-down converter switching losses.

## Application Information (Cont.)

For the condition where the step-down converter is in dropout at 100% duty cycle, the total device dissipation reduces to:

$$P_D = I_O^2 R_{DS(ON)H} + I_Q V_{IN}$$

Since  $R_{DS(ON)}$ , quiescent current, and switching losses all vary with input voltage, the total losses should be investigated over the complete input voltage range. The maximum power dissipation depends on the thermal resistance of IC package, PCB layout, the rate of surrounding airflow and temperature difference between junction and ambient. The maximum power dissipation can be calculated by the following formula:

$$P_D = \frac{T_{J(MAX)} - T_A}{\theta_{JA}}$$

Where  $T_{J(MAX)}$  is the maximum allowable junction temperature +125°C.  $T_A$  is the ambient temperature and  $\theta_{JA}$  is the thermal resistance from the junction to the ambient. Based on the standard JEDEC for a two layers thermal test board, the thermal resistance  $\theta_{JA}$  of TSOT25 package is 250°C/W. The maximum power dissipation at  $T_A = +25^\circ\text{C}$  can be calculated by following formula:

$$P_D = (125^\circ\text{C} - 25^\circ\text{C}) / 250^\circ\text{C/W} = 0.4\text{W}$$

### Setting the Output Voltage

The internal reference is 0.6V (Typical). The output voltage is calculated as below:

The output voltage is given by Table 1.

$$V_O = 0.6 \times \left( 1 + \frac{R_1}{R_2} \right)$$

**Table 1:** Resistor selection for output voltage setting.

| $V_O$ | R1   | R2   |
|-------|------|------|
| 1.2V  | 100k | 100k |
| 1.5V  | 150k | 100k |
| 1.8V  | 200k | 100k |
| 2.5V  | 380k | 120k |
| 3.3V  | 540k | 120k |

### 100% Duty Cycle Operation

As the input voltage approaches the output voltage, the converter turns the P-channel transistor continuously on. In this mode the output voltage is equal to the input voltage minus the voltage drop across the P-Channel transistor:

$$V_{OUT} = V_{IN} - I_{LOAD}(R_{DS(ON)} + R_L)$$

where  $R_{DS(ON)}$  = P-Channel switch ON resistance,  $I_{LOAD}$  = Output Current,  $R_L$  = Inductor DC Resistance

### UVLO and Soft-Start

The reference and the circuit remain reset until the  $V_{IN}$  crosses its UVLO threshold. The PAM2312 has an internal soft-start circuit that limits the in-rush current during start-up. This prevents possible voltage drops of the input voltage and eliminates the output voltage overshoot. The soft-start acts as a digital circuit to increase the switch current in several steps to the P-channel current limit (1500mA).

### Short Circuit Protection

The switch peak current is limited cycle-by-cycle to a typical value of 1500mA. In the event of an output voltage short circuit, the device operates with a frequency of 500kHz and minimum duty cycle, therefore the average input current is typically 200mA.

### Thermal Shutdown

When the die temperature exceeds +150°C, a reset occurs and the reset remains until the temperature decrease to +120°C, at which time the circuit can be restarted.

**Application Information** (Cont.)

**PCB Layout Check List**

When laying out the printed circuit board, the following checklist should be used to ensure proper operation of the PAM2312. These items are also illustrated graphically in Figure 1. Check the following in your layout:

1. The power traces, consisting of the GND trace, the SW trace and the  $V_{IN}$  trace should be kept short, direct and wide.
2. Does the  $V_{FB}$  pin connect directly to the feedback resistors? The resistive divider R1/R2 must be connected between the (+) plate of  $C_{OUT}$  and ground.
3. Does the (+) plate of  $C_{IN}$  connect to  $V_{IN}$  as closely as possible? This capacitor provides the AC current to the internal power MOSFETs.
4. Keep the switching node, SW, away from the sensitive  $V_{FB}$  node.
5. Keep the (-) plates of  $C_{IN}$  and  $C_{OUT}$  as close as possible.

**Ordering Information**

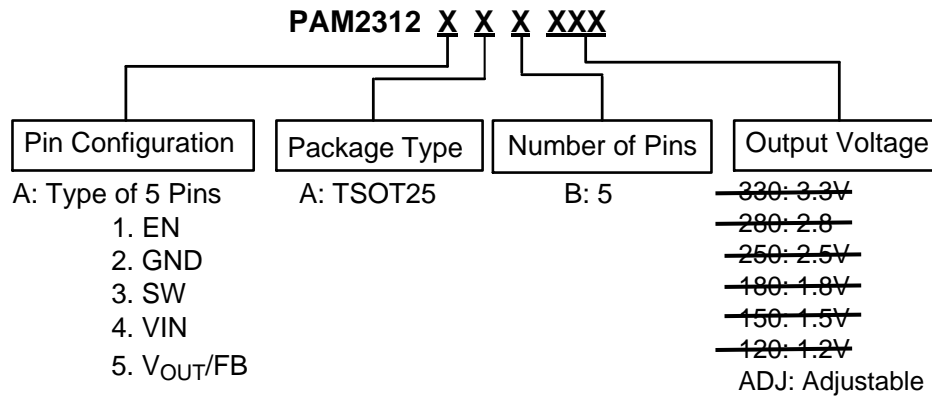

| Part Number   | Output Voltage (V) | Package (Note 6) | Tape and Reel Quantity | Status (Note 5) |
|---------------|--------------------|------------------|------------------------|-----------------|
| PAM2312AABADJ | ADJ                | TSOT25           | 3000                   | In Production   |

Notes: 5. All variants with output voltage of 1.2V, 1.5V, 1.8V, 2.5V, 2.8V and 3.3V are End of Life (EOL) with no replacement.  
6. For packaging details, go to our website at <https://www.diodes.com/design/support/packaging/diodes-packaging/>.

**Marking Information**

Top View

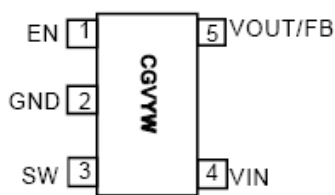

TSOT25

CG: Product Code of PAM2312  
V: Output Voltage  
Y: Year  
W: Week  
X: Internal Code

**Package Outline Dimensions** (All dimensions in mm.)

Please see <http://www.diodes.com/package-outlines.html> for the latest version.

**TSOT25**

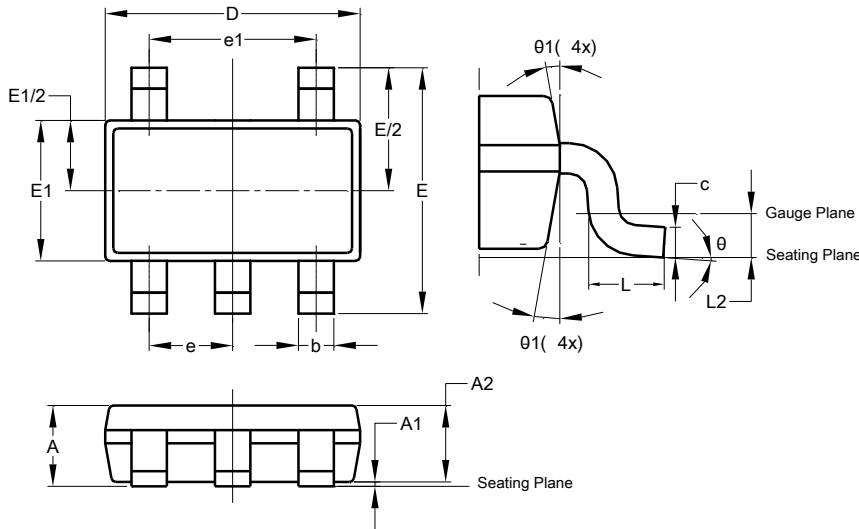

| TSOT25               |          |      |      |
|----------------------|----------|------|------|
| Dim                  | Min      | Max  | Typ  |
| A                    | -        | 1.00 | -    |
| A1                   | 0.01     | 0.10 | -    |
| A2                   | 0.84     | 0.90 | -    |
| b                    | 0.30     | 0.45 | -    |
| c                    | 0.12     | 0.20 | -    |
| D                    | -        | -    | 2.90 |
| E                    | -        | -    | 2.80 |
| E1                   | -        | -    | 1.60 |
| e                    | 0.95 BSC |      |      |
| e1                   | 1.90 BSC |      |      |
| L                    | 0.30     | 0.50 | -    |
| L2                   | 0.25 BSC |      |      |
| $\theta$             | 0°       | 8°   | 4°   |
| $\theta_1$           | 4°       | 12°  | -    |
| All Dimensions in mm |          |      |      |

**Suggested Pad Layout**

Please see <http://www.diodes.com/package-outlines.html> for the latest version.

**TSOT25**

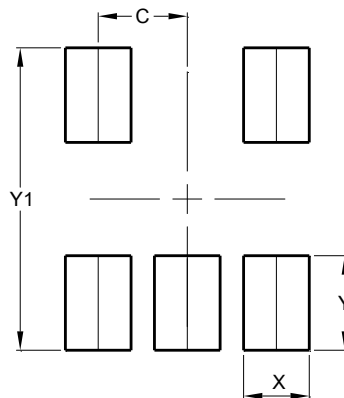

| Dimensions | Value (in mm) |
|------------|---------------|
| C          | 0.950         |
| X          | 0.700         |
| Y          | 1.000         |
| Y1         | 3.199         |

**IMPORTANT NOTICE**

DIODES INCORPORATED MAKES NO WARRANTY OF ANY KIND, EXPRESS OR IMPLIED, WITH REGARDS TO THIS DOCUMENT, INCLUDING, BUT NOT LIMITED TO, THE IMPLIED WARRANTIES OF MERCHANTABILITY AND FITNESS FOR A PARTICULAR PURPOSE (AND THEIR EQUIVALENTS UNDER THE LAWS OF ANY JURISDICTION).

Diodes Incorporated and its subsidiaries reserve the right to make modifications, enhancements, improvements, corrections or other changes without further notice to this document and any product described herein. Diodes Incorporated does not assume any liability arising out of the application or use of this document or any product described herein; neither does Diodes Incorporated convey any license under its patent or trademark rights, nor the rights of others. Any Customer or user of this document or products described herein in such applications shall assume all risks of such use and will agree to hold Diodes Incorporated and all the companies whose products are represented on Diodes Incorporated website, harmless against all damages.

Diodes Incorporated does not warrant or accept any liability whatsoever in respect of any products purchased through unauthorized sales channel. Should Customers purchase or use Diodes Incorporated products for any unintended or unauthorized application, Customers shall indemnify and hold Diodes Incorporated and its representatives harmless against all claims, damages, expenses, and attorney fees arising out of, directly or indirectly, any claim of personal injury or death associated with such unintended or unauthorized application.

Products described herein may be covered by one or more United States, international or foreign patents pending. Product names and markings noted herein may also be covered by one or more United States, international or foreign trademarks.

This document is written in English but may be translated into multiple languages for reference. Only the English version of this document is the final and determinative format released by Diodes Incorporated.

**LIFE SUPPORT**

Diodes Incorporated products are specifically not authorized for use as critical components in life support devices or systems without the express written approval of the Chief Executive Officer of Diodes Incorporated. As used herein:

A. Life support devices or systems are devices or systems which:

1. are intended to implant into the body, or
2. support or sustain life and whose failure to perform when properly used in accordance with instructions for use provided in the labeling can be reasonably expected to result in significant injury to the user.

B. A critical component is any component in a life support device or system whose failure to perform can be reasonably expected to cause the failure of the life support device or to affect its safety or effectiveness.

Customers represent that they have all necessary expertise in the safety and regulatory ramifications of their life support devices or systems, and acknowledge and agree that they are solely responsible for all legal, regulatory and safety-related requirements concerning their products and any use of Diodes Incorporated products in such safety-critical, life support devices or systems, notwithstanding any devices- or systems-related information or support that may be provided by Diodes Incorporated. Further, Customers must fully indemnify Diodes Incorporated and its representatives against any damages arising out of the use of Diodes Incorporated products in such safety-critical, life support devices or systems.

Copyright © 2018, Diodes Incorporated

[www.diodes.com](http://www.diodes.com)

# Mouser Electronics

Authorized Distributor

Click to View Pricing, Inventory, Delivery & Lifecycle Information:

[Diodes Incorporated:](#)

[PAM2312AABADJ](#)