

AK6 Series



Agency Approvals

AGENCY	AGENCY FILE NUMBER
	E128662

Maximum Ratings and Thermal Characteristics (T_A=25°C unless otherwise noted)

Parameter	Symbol	Value	Unit
Operating Storage Temperature Range	T _{STG}	-55 to 150	°C
Operating Junction Temperature Range	T _J	-55 to 125	°C
Current Rating ¹	I _{PP}	6	kA

Note:

1. Rated I_{PP} measured with 8/20µS pulse.

Functional Diagram

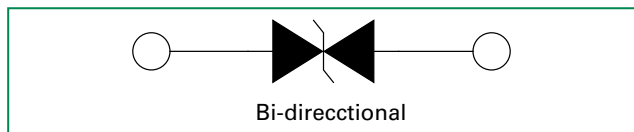

Description

The AK6 series of high power TVS diode is specially designed for meeting severe surge test environment of both AC and DC line protection applications. It features a very fast response and ultra low clamping characteristics over traditional metal oxide (MOV) solutions. They can be connected in series and / or parallel to create a very high surge current protection solution.

Features

- Very low clamping voltage
- Ultra compact: less than one-tenth the size of traditional discrete solutions
- Sharp breakdown voltage
- Low slope resistance
- Bi-directional
- Foldbak technology for superior clamping factor
- Symmetric in leads width for easier soldering during assembly.
- IEC-61000-4-2 ESD 15kV(Air), 8kV (Contact)
- ESD protection of data lines in accordance with IEC 61000-4-2
- EFT protection of data lines in accordance with IEC 61000-4-4
- Halogen-free
- RoHS compliant
- Glass passivated junction
- Pb-free E4 means 2nd level interconnect is Pb-free and the terminal finish material is silver

Additional Information



Datasheet



Resources



Samples

Part Numbers	Part Marking	Standoff Voltage (V _{SO}) Volts	Max. Reverse Leakage (I _R) @ V _{SO} µA	Typical I _R @ 85°C (µA)	Reverse Breakdown Voltage (V _{BR}) @ I _T		Test Current I _T (mA)	Max. Clamping Voltage Peak Pulse Current (I _{PP}) (Note 1)		Max. Temp Coefficient OF V _{BR} (%/°C)	Max. Capacitance 0 Bias 10kHz (nF)	Agency Approval 
					Min Volts	Max Volts		V _{CL} Volts	I _{PP} Amps			
AK6 - 030C	6 - 030C	30	10	15	32	37	10	90	6,000	0.1	11.0	X
AK6 - 058C	6 - 058C	58	10	15	64	70	10	110	6,000	0.1	8.0	X
AK6 - 066C	6 - 066C	66	10	15	72	80	10	120	6,000	0.1	6.0	X
AK6 - 076C	6 - 076C	76	10	15	85	95	10	140	6,000	0.1	6.5	X
AK6 - 170C	6 - 170C	170	10	15	180	220	10	260	6,000	0.1	2.8	X
AK6 - 190C	6 - 190C	190	10	15	200	245	10	290	6,000	0.1	2.5	X
AK6 - 240C	6 - 240C	240	10	15	250	285	10	340	6,000	0.1	2.0	X
AK6 - 380C	6 - 380C	380	10	15	401	443	10	520	6,000	0.1	1.4	X
AK6 - 430C	6 - 430C	430	10	15	440	490	10	625	6,000	0.1	1.0	X

Note: Using 8/20µS wave shape as defined in IEC 61000-4-5.

Physical Specifications

Weight	Contact manufacturer
Case	Epoxy encapsulated
Terminal	Silver plated leads, solderable per MIL-STD-750 Method 2026

Flow/Wave Soldering (Solder Dipping)

Peak Temperature :	265°C
Dipping Time :	10 seconds
Soldering :	1 time

Wave Solder Profile

Figure 1 - Non Lead-free Profile

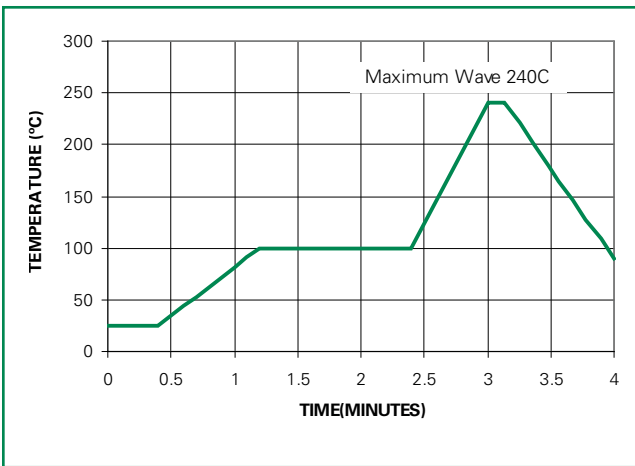
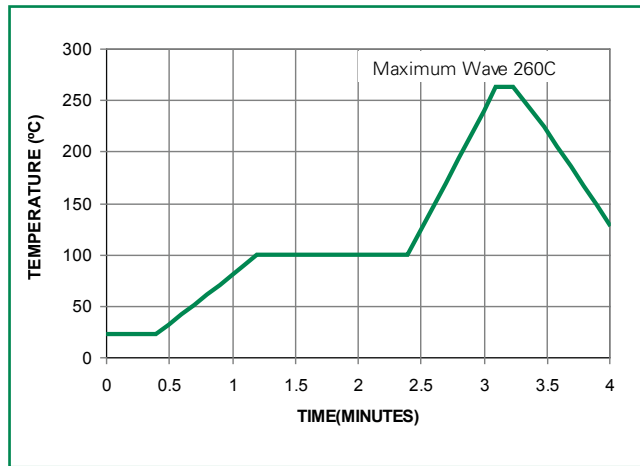

Figure 2 - Lead-free Profile



Ratings and Characteristic Curves (T_j=25°C unless otherwise noted)

Figure 3 - Peak Power Derating

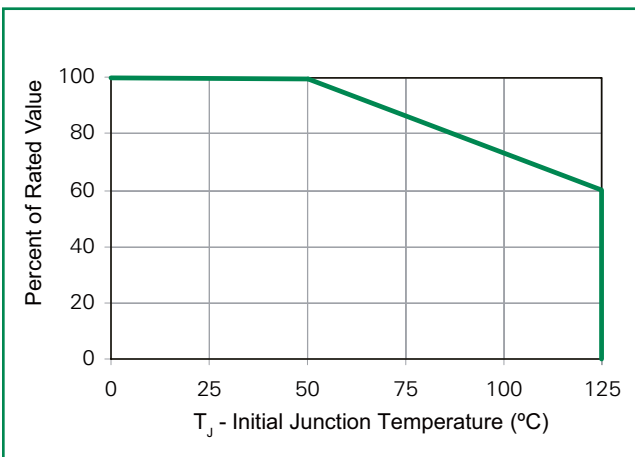
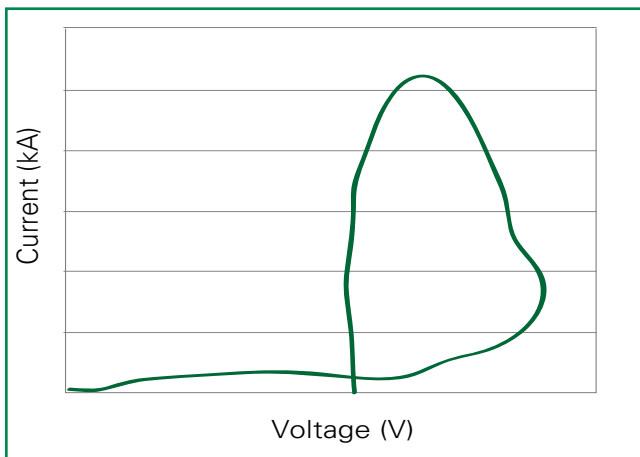

Figure 4 - Surge Response



continues on next page.

Ratings and Characteristic Curves ($T_A=25^\circ\text{C}$ unless otherwise noted) (Continued)

Figure 5 - Typical Peak Pulse Power Rating Curve

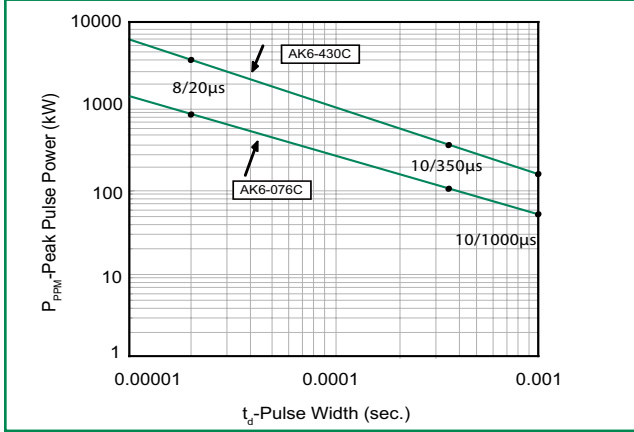

Figure 6 - Typical V_{BR} Vs Junction Temperature

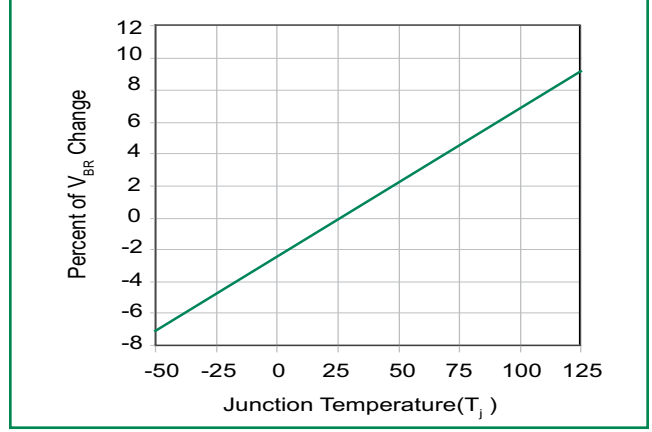
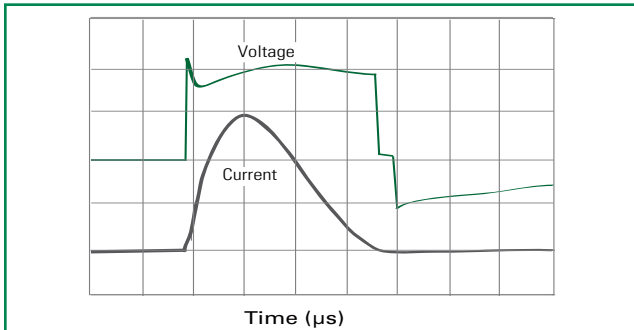

Figure 7 -Surge Response (8/20 Surge current waveform)



Note:

The power dissipation causes a change in avalanche voltage during the surge and the avalanche voltage eventually returns to the original value when the transient has passed.

Figure 8 - Pulse Waveform

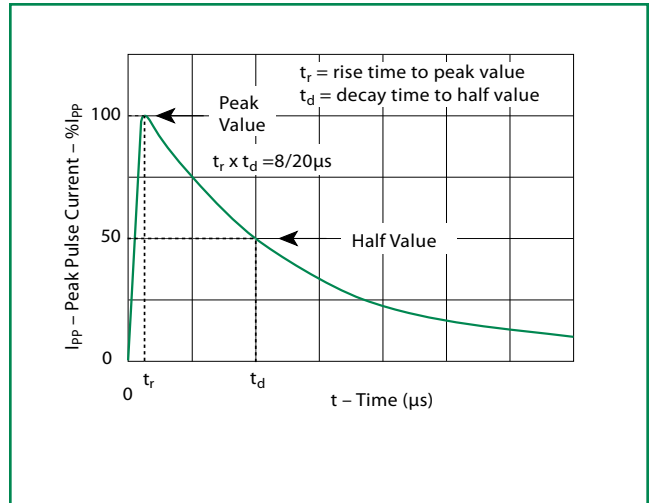

Dimensions

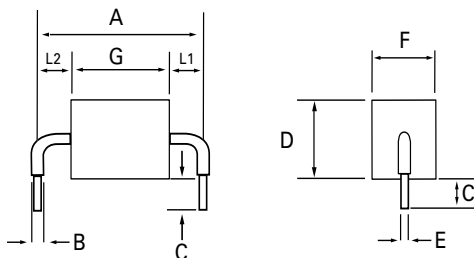

Dimensions	Inches	Millimeters
A	0.950 +/- 0.040	24.15 +/- 1.00
B	0.095 +/- 0.024	2.4 +/- 0.60
C	0.236 +/- 0.040	6.00 +/- 1.00
D	0.570 max.	14.48 max.
E	0.050 +/- 0.002	1.270 +/- 0.05
F	0.500 max.	12.70 max.
G - 030C	0.161 +/- 0.040	4.10 +/- 1.00
G - 058C/066C 076C	0.189 +/- 0.040	4.8 +/- 1.00
G - 170C/190C	0.320 +/- 0.040	8.13 +/- 1.00
G - 240C	0.370 +/- 0.040	9.4 +/- 1.00
G - 380C/430C	0.543 +/- 0.040	13.8 +/- 1.00
L1/L2	L1= L2 tolerance +/- 0.04 inch (1.0 mm)	

Part Marking System

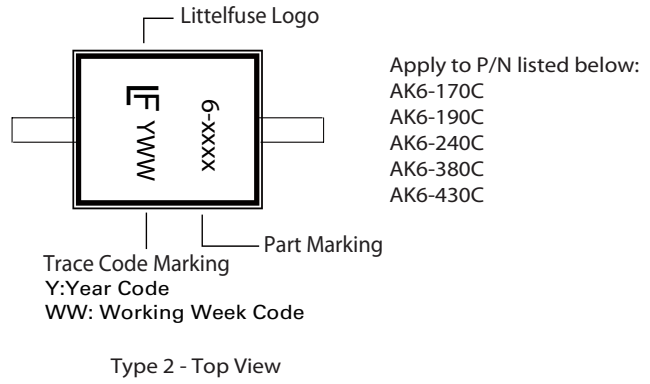
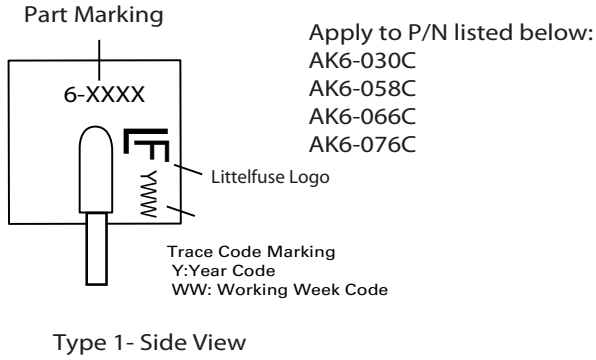

Part Numbering System

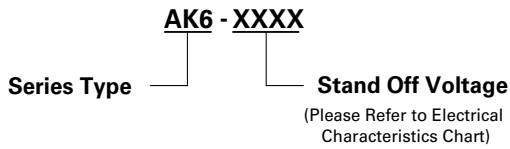

Packing Options

Part Number	Component Package	Quantity	Packaging Option
AK6-XXXX	AK Package	56pcs/Box	Bulk
AK6-XXXX-12	AK Package	12pcs/Box	Bulk