

# ECM40-60



- 40 & 60 Watt Models
- Small Size 2.0" x 4.0" x 1.2"
- Low Leakage Current
- Industrial & Medical Approvals
- Full Load Available Convection Cooled
- Wide Operating Temperature 0 °C to +70 °C
- Level B Conducted Emissions
- EN61000 Compliant
- Universal AC Input 90–264 VAC
- Input Frequency 47–63 & 440 Hz
- Single & Multiple Outputs
- Cover Kits Available
- Mating Connector & Loom Kits Available

Approved for Class I and Class II applications, the ECM range of single and multiple output AC-DC, 40-60 W power supplies from XP feature the world's smallest footprint for units of these ratings. Both are just 2" x 4" (50.8 mm x 101.6 mm) and 1.2" (30.48 mm) high. Furthermore, these high-density power supplies meet EN55032 Level B conducted emissions with maximum leakage currents of 100  $\mu$ A at 115 VAC or 200  $\mu$ A at 230 VAC. As a result, these switchers are equally suitable for industrial, IT and medical applications, with no price premium for meeting medical requirements.

The ECM40-60 series have single output versions from 5 V to 48 VDC, adjustable by  $\pm 10\%$ , and dual and triple output versions covering combinations of 3.3 V, 5 V, 12 V, 15 V and 24 V. They are dual-fused for compliance with IEC60601-1 and efficiency is 80-85%, depending upon the model, so minimal excess heat is generated.

The power supplies deliver full power between 0 °C and +50 °C and will operate at up to +70 °C with derating and only 5 CFM of cooling. Comprehensive overvoltage, overload and short circuit protection is built in. Covers, looms and connector kits are available.

## Input Characteristics

Characteristic	Minimum	Typical	Maximum	Units	Notes & Conditions
Input Voltage - Operating	90		264	VAC	120-370 VDC
Input Frequency	47	50/60	63	Hz	400 Hz operation available
Input Current - No load			41	mA	230 VAC
Input Current - Full load			1.38	A	90 VAC
Inrush Current			40	A	Cold start at 230 VAC
Power Factor		0.62			230 VAC
Earth Leakage Current			290	μA	264 VAC
Input Protection					T3.15 A/ 250 V internal fuse in line & neutral

All specifications are at nominal input, full resistance load at 25°C unless otherwise stated.

## Output Characteristics

Characteristic	Minimum	Typical	Maximum	Units	Notes & Conditions
Output Voltage	5.0		48.0	VDC	See modules table
Initial Set Accuracy			V <sup>1</sup> : ±1, V <sup>2</sup> & V <sup>3</sup> : ±5	%	
Output Voltage Trim	±10			%	V <sup>1</sup> (V <sup>2</sup> will track V <sup>1</sup> by the same %)
Minimum load	V <sup>1</sup> : 0.5, V <sup>2</sup> : 0.1			A	Not required on single output models
Start Up Delay			1.5	s	90 VAC
Start Up Rise Time			10	ms	
Hold Up Time	16		75	ms	115-230 VAC input
Drift			±0.2	%	
Line Regulation			±0.5	%	90-264 VAC
Load Regulation			±1.0	%	Single output
			V <sup>1</sup> : ±3, V <sup>2</sup> & V <sup>3</sup> : ±5	%	Dual output
Transient Response			4	%	Output voltage recovers to within 1% in less than 500 μs for 50% load change.
Ripple & Noise			1	%pk-pk	20 MHz bandwidth
Overvoltage Protection	115		135	VDC	Recycle input to reset
Overload Protection	110		170	% I <sub>max</sub>	Auto-recovery
Short Circuit Protection					Trip & restart (hiccup mode)
Temperature Coefficient			0.05	%/°C	

## General Specifications

Characteristic	Minimum	Typical	Maximum	Units	Notes & Conditions	
Efficiency	70			%	3.3 & 5 V single output versions	
	80				(at 230 VAC full load)	All other single output versions
	75					Dual output versions
Isolation Voltage		4000		VAC	Input to output	
		1500			Input to ground	
		500			Output to ground	
Switching Frequency		70		kHz	Fixed	
Power Density			6.25	W/In <sup>3</sup>	For 60 W version	
Weight		0.33 (150)		lbs (g)		
MTBF		600		kHrs	Mil HDBK 217F	

## Environmental

Characteristic	Minimum	Typical	Maximum	Units	Notes & Conditions
Operating Temperature	-0		+70	°C	See derating curves
Storage Temperature	-40		+85	°C	
Cooling		0		CFM	Convection-cooled
Operating Humidity			95	% RH	Non- condensing
Operating Altitude			3000	m	
Shock			30	Gpk	Half sine 6 axis
Vibration			2	G	5-500 Hz 3 axis

## Electromagnetic Compatibility & Immunity

Standard	Test Level	Criteria	Notes & Conditions
Emissions	EN55032	Class B Conducted	
	EN55032	Class A Radiated	
	EN60601-1-2	Class B Conducted	
Harmonic Currents	EN61000-3-2		
Voltage Flicker	EN61000-3-3		
ESD Immunity	EN61000-4-2	level 2, performance criteria A	
Radiated Immunity	EN61000-4-3	10 V/m, performance criteria A	
EFT/Burst	EN61000-4-4	level 2, performance criteria A	
Surge	EN61000-4-5	level 3, performance criteria A	
Conducted Immunity	EN61000-4-6	10 Vrms, performance criteria A	
Dips & Interruptions	EN61000-4-11	70% U <sup>T</sup> : performance criteria A	For 10 ms, 100% load
		40% U <sup>T</sup> : performance criteria B	For 100 ms, 100% load
		0% U <sup>T</sup> : performance criteria B	For 5000 ms, 100% load
Dips & Interruptions	EN61000-4-11 (Medical)	70% U <sub>t</sub> , performance criteria A	For 500 ms, Medical, 100% load
		40% U <sub>t</sub> , performance criteria A	For 100 ms, Medical, 60% load
		0% U <sub>t</sub> , performance criteria A	For 10 ms, Medical, 100% load
		0% U <sub>t</sub> , performance criteria B	For 5000 ms, Medical, 100% load

## Safety Approvals

Safety Agency	Safety Standard	Category
CB Report	IEC60950-1:2005 Ed 2 / IEC62368-1:2014	Information Technology
UL	UL 62368-1 & CAN/CSA C22.2 No. 62368-1-14	Information Technology
TUV	EN62368-1:2014/A11:2017	Information Technology
CE	LVD	

Safety Agency	Safety Standard	Category
CB Report	Certificate #US/18293 & 18269/UL, IEC60601-1 Ed 3 Including Risk Management	Medical
UL	UL File # E146893, ANSI/AAMI ES 60601-1:2005 & CSA C22.2 No. 60601-1:08	Medical
TUV	TUV Certificate # B12 01 57396 125, EN60601-1:2006	Medical

Means of Protection		Category
Primary to Secondary	1 x MOPP (Means of Patient Protection) Contact Sales for 2 x MOPP	IEC60601-1 Ed 3
Primary to Earth	1 x MOPP (Means of Patient Protection)	

Equipment Protection Class	Safety Standard	Notes & Conditions
Class I & Class II	IEC60950-1:2005 Ed 2 / IEC62368-1:2014	See safety agency conditions of acceptability for details

## Models & Ratings

Max Power	Outputs						Model Number
	V1	Imin/Imax <sup>③</sup>	V2	Imin/Imax	V3	Imin/Imax	
40 W	5.0V	0.0 A / 8.0 A					ECM40US05†*
	7.0V	0.0 A / 5.7 A					ECM40US07
	9.0V	0.0 A / 4.4 A					ECM40US09*
	12.0V	0.0 A / 3.5 A					ECM40US12†*
	15.0V	0.0 A / 2.7 A					ECM40US15†*
	18.0V	0.0 A / 2.2 A					ECM40US18
	24.0V	0.0 A / 1.7 A					ECM40US24†*
	33.0V	0.0 A / 1.2 A					ECM40US33
	48.0V	0.0 A / 0.9 A					ECM40US48†*
	+5.0V	0.5 A / 6.0 A	+12.0V	0.1 A / 2.0 A			ECM40UD21
	+5.0V	0.5 A / 6.0 A	+15.0V	0.1 A / 1.5 A			ECM40UD22
	+5.0V	0.5 A / 6.0 A	+12.0V	0.1 A / 2.0 A	-12.0V	0.0 A / 0.5 A	ECM40UT31†*
	+5.0V	0.5 A / 6.0 A	+24.0V	0.1 A / 1.0 A	-12.0V	0.0 A / 0.5 A	ECM40UT32†
	+5.0V	0.5 A / 6.0 A	+15.0V	0.1 A / 1.5 A	-15.0V	0.0 A / 0.5 A	ECM40UT33†*
	+3.3V	0.5 A / 6.0 A	+5.0V	0.1 A / 1.5 A	+12.0V	0.0 A / 0.5 A	ECM40UT34†*
	+5.0V	0.5 A / 6.0 A	+3.3V	0.1 A / 1.5 A	+12.0V	0.0 A / 0.5 A	ECM40UT35†

Max Power	Outputs						Model Number
	V1	Imin/Imax <sup>③</sup>	V2	Imin/Imax	V3	Imin/Imax	
60 W	5.0V	0.0 A / 12.00 A					ECM60US05†*
	7.0V	0.0 A / 8.60 A					ECM60US07
	9.0V	0.0 A / 6.70 A					ECM60US09*
	12.0V	0.0 A / 5.00 A					ECM60US12†*
	15.0V	0.0 A / 4.00 A					ECM60US15†*
	18.0V	0.0 A / 3.30 A					ECM60US18
	20.0V	0.0 A / 3.00 A					ECM60US20
	24.0V	0.0 A / 2.50 A					ECM60US24†*
	28.0V	0.0 A / 2.14 A					ECM60US28
	33.0V	0.0 A / 1.80 A					ECM60US33
	48.0V	0.0 A / 1.25 A					ECM60US48†*
	+5.0V	0.5 A / 8.00 A	+12.0V	0.1 A / 3.0 A			ECM60UD21
	+5.0V	0.5 A / 8.00 A	+15.0V	0.1 A / 2.5 A			ECM60UD22
	+5.0V	0.5 A / 8.00 A	+12.0V	0.1 A / 3.0 A	-12.0V	0.0 A / 0.5 A	ECM60UT31†*
	+5.0V	0.5 A / 8.00 A	+24.0V	0.1 A / 1.5 A	-12.0V	0.0 A / 0.5 A	ECM60UT32†
	+5.0V	0.5 A / 8.00 A	+15.0V	0.1 A / 2.5 A	-15.0V	0.0 A / 0.5 A	ECM60UT33†*
	+3.3V	0.5 A / 8.00 A	+5.0V	0.1 A / 1.5 A	+12.0V	0.0 A / 0.5 A	ECM60UT34†*
	+5.0V	0.5 A / 8.00 A	+3.3V	0.1 A / 1.5 A	+12.0V	0.0 A / 0.5 A	ECM60UT35†

### Notes

1. V2 will track a change in V1 by the same percentage change in voltage as V1 is trimmed.
2. To receive unit with cover fitted, add suffix '-C' to model number. For Class I operation only.
3. A 120% peak load can be taken for up to 100 ms with a 25% duty cycle. Average load not to exceed maximum power rating.

† Available from Farnell InOne.

\*Available from Newark InOne.

## Thermal Derating Curves

All ECM40 models convection-cooled

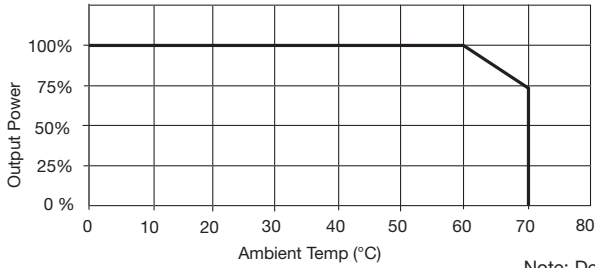

Note: Derate by 10% if cover is fitted

All ECM40 models with 5 CFM

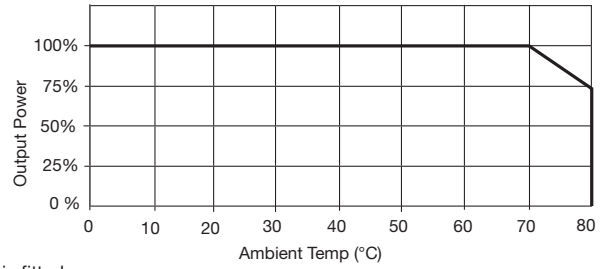

All ECM60 models convection-cooled

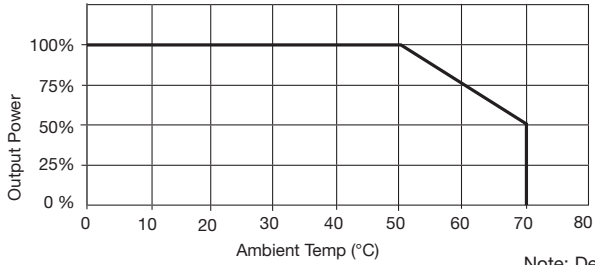

Note: Derate by 10% if cover is fitted

All ECM60 models with 5 CFM

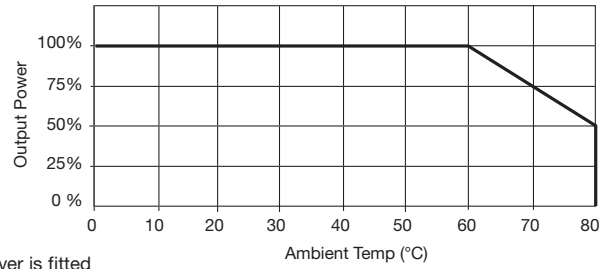

## Transient Response

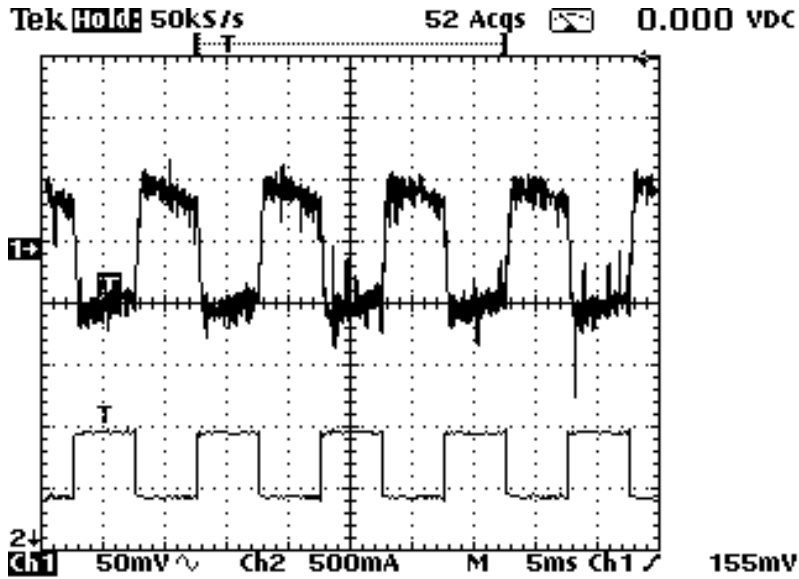

ECM60US24 25% load change

## Efficiency Versus Input Voltage

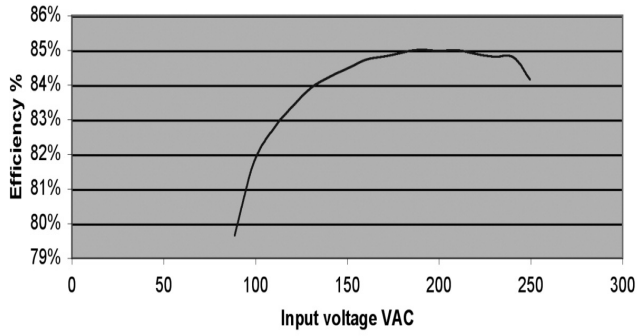

ECM60US24 with 60 W load

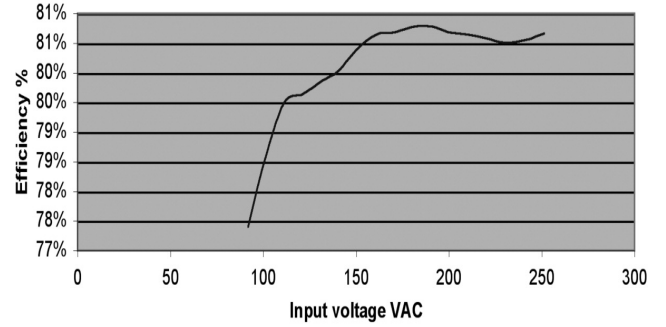

ECM60UT33 with 50 W load

## Efficiency Versus Output Load

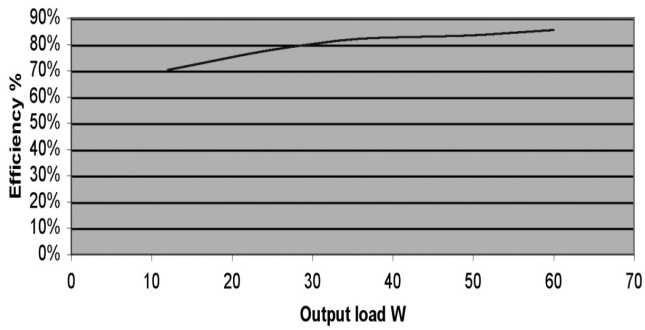

ECM60US24 at 230 VAC input

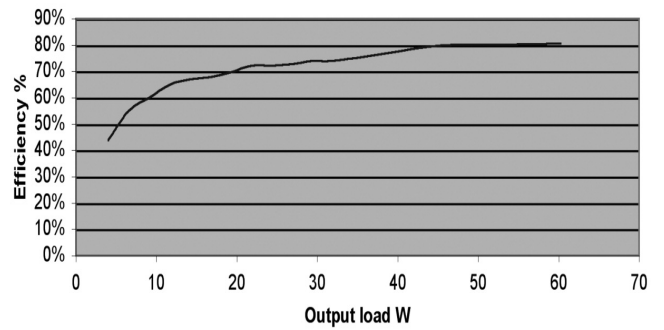

ECM60UT33 at 230 VAC input

## Start Up Delay

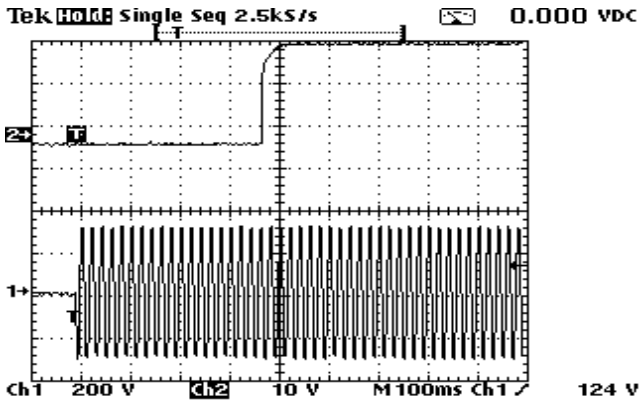

ECM60US24 with 60 W load

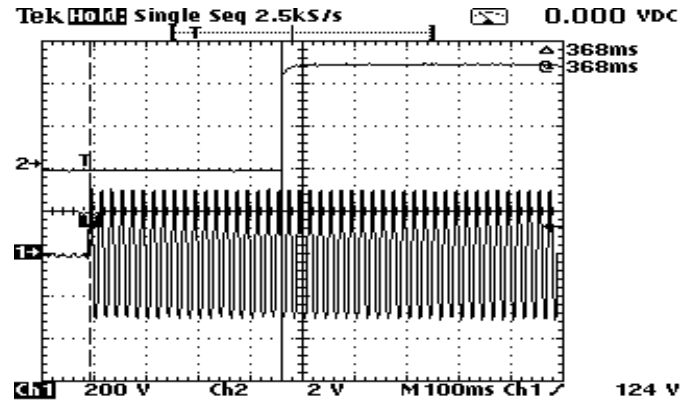

ECM60UT33 with 60 W load

## Hold Up Tme

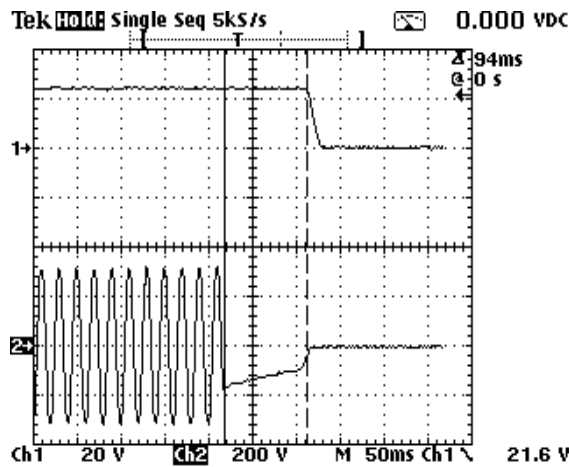

ECM60US24 with 60 W load at 230 VAC

## Overload Characteristics

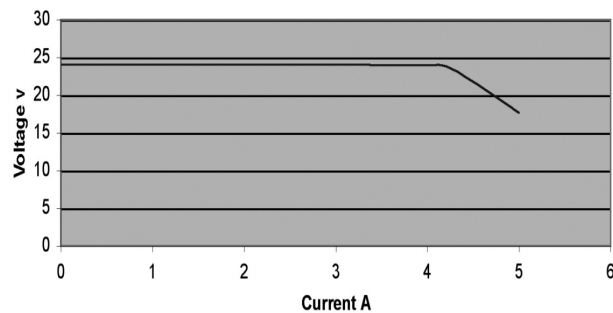

ECM60US24. When current reaches 5.4 A, output goes into trip and restart (hiccup) mode

## Ripple & Noise

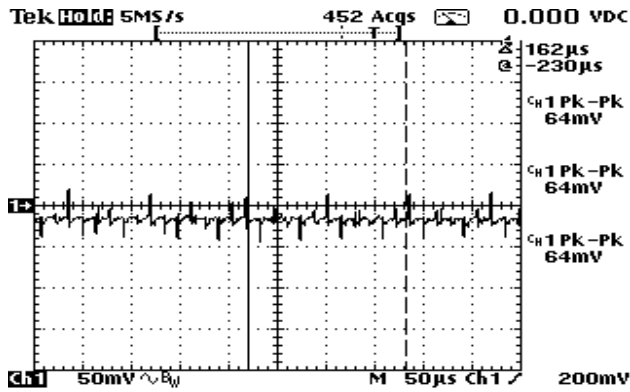

ECM60US24 with 60 W load  
 Noise measured is 64 mV pk-pk

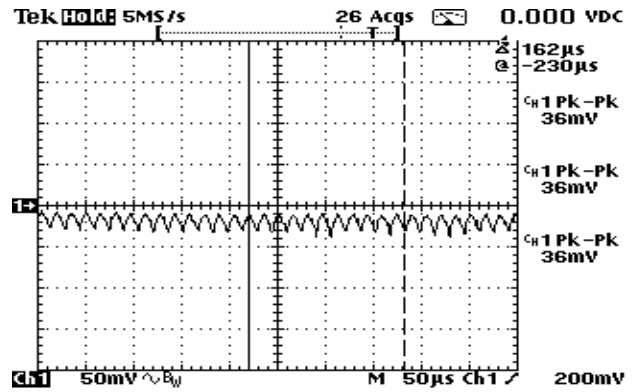

ECM60UT33 output 1 with 30 W load.  
 Noise measured is 36 mV pk-pk

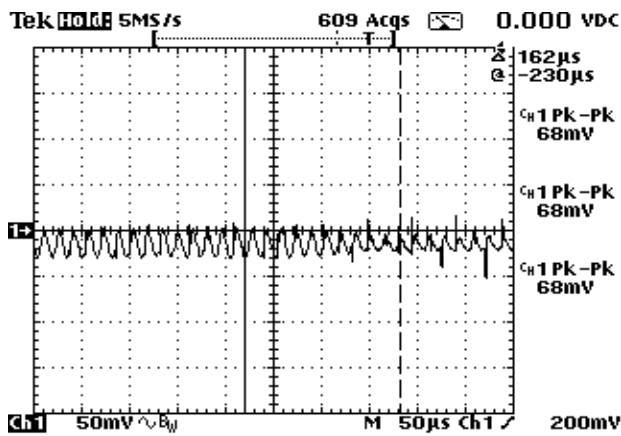

ECM60UT33 output 2 with 15 W load.  
 Noise measured is 68 mV pk-pk

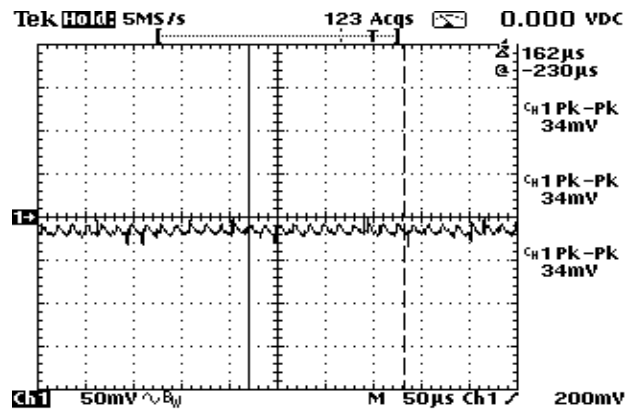

ECM60UT33 output 3 with 7 W load.  
 Noise measured is 34 mV pk-pk



# Conducted Noise

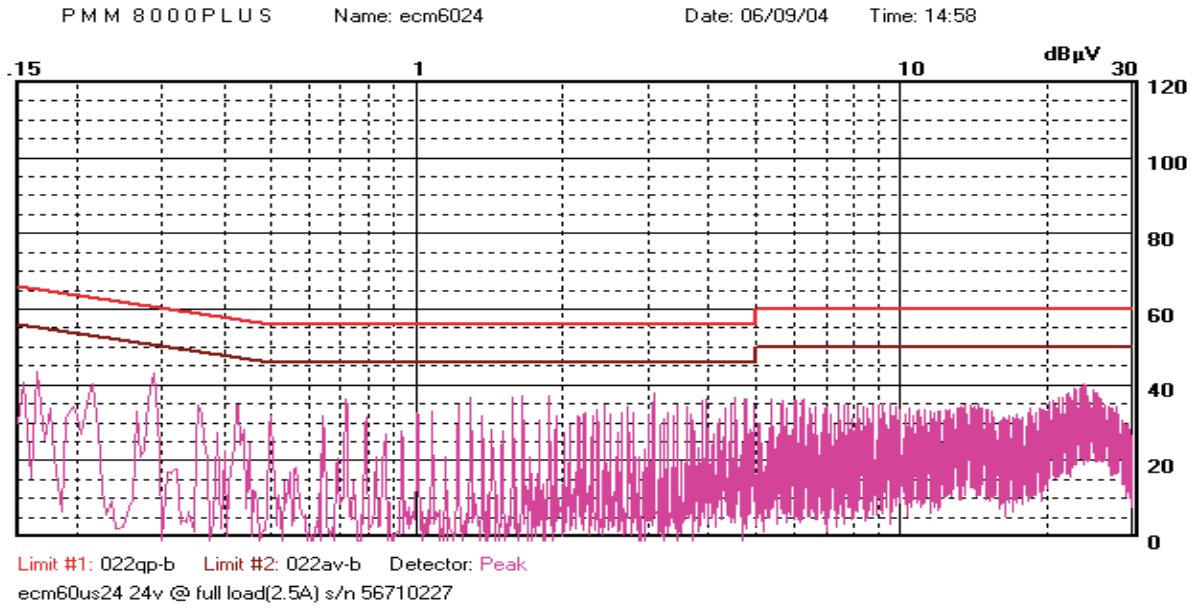

ECM60US24 at full load

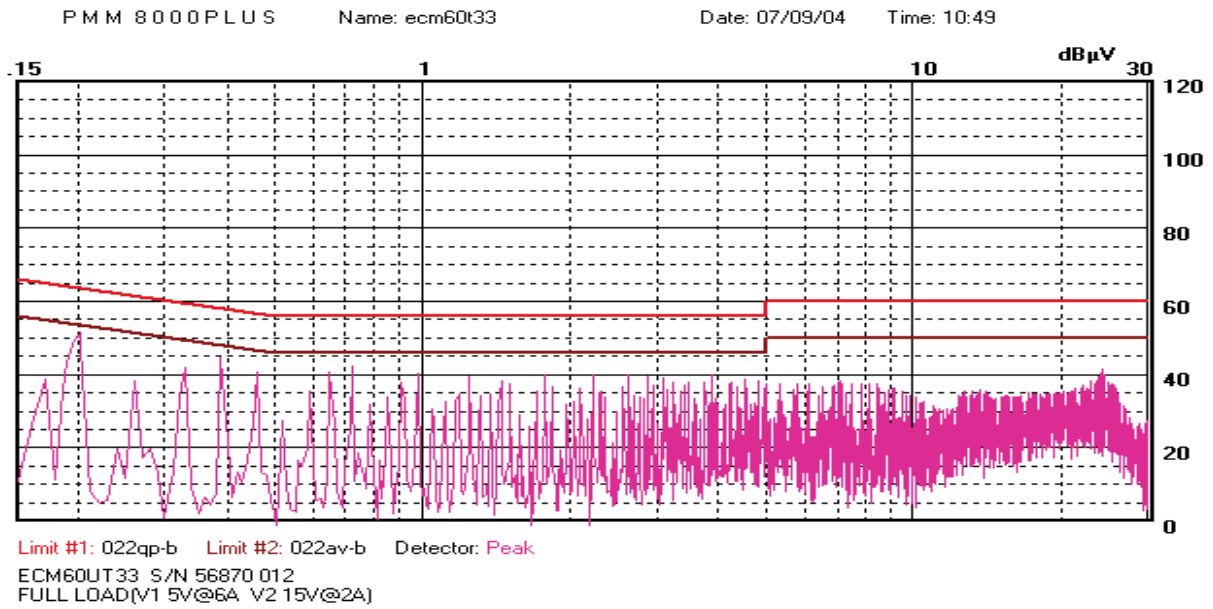

ECM60UT33 at full load

## Mechanical Details - Single Output Models

Weight: approx. 0.33 lb (150g)

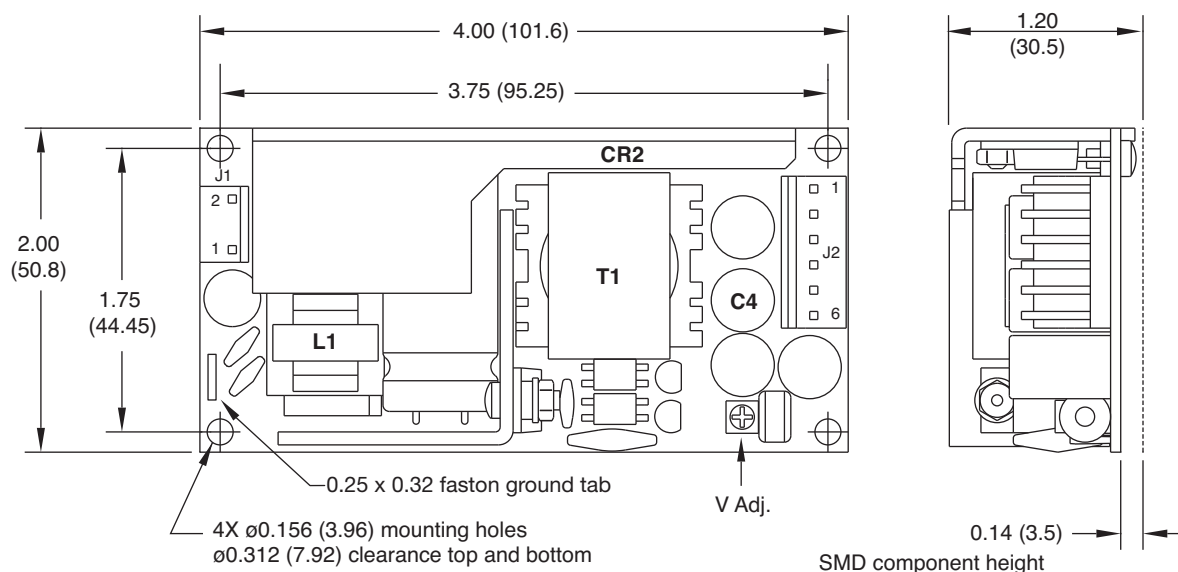

Input Connector J1	
Pin 1	Line
Pin 2	Neutral

J1 mates with Molex housing 43061-0003 and Molex series 5194 crimp terminals. Ground (0.25 faston) tab standard.

Output Connector J2	
Pin	Single
1	+V1
2	+V1
3	RTN
4	RTN
5	N.C.
6	N.C.

J2 mates with Molex housing 43061-0006 & Molex series 5194 crimp terminals.

### Notes

- All dimensions in inches (mm). Tolerance .xx = ±0.02 (0.50); .xxx = ±0.01 (0.25)
- Cable harnesses with 300mm wire available.  
For single output models, order part number ECM40/60S LOOM.  
For multi-output models, order part number ECM40/60DT LOOM .
- Mating connector kit available. Order part number ECM40/60 CONKIT.
- Covers available. Order part number ECM40/60 COVER. Cover dimensions are 4.49 x 2.52 x 1.52 (114 x 64 x 38.5)
- † All accessories available from Farnell InOne.

## Thermal Considerations

To ensure correct and safe operation of the PSU, the temperature of the components listed in the table below must not be exceeded. See mechanical details for component locations.

Component	Maximum Temperature
L1	110 °C
T1	110 °C
CR2	120 °C
C4	95 °C

## Mechanical Details - Single Output Models (3 x 5)

Weight: approx. 0.4 lb (180 g)

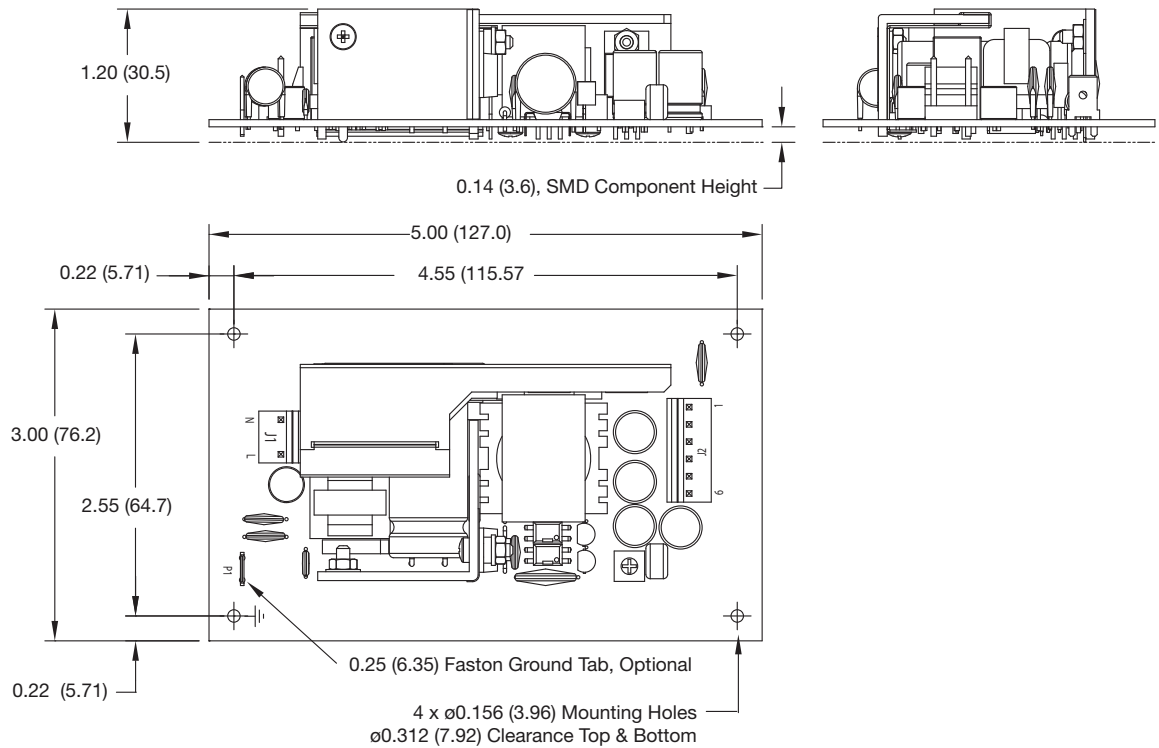

Input Connector J1	
Pin 1	Line
Pin 2	Neutral

J1 mates with Molex housing 43061-0003 and Molex series 5194 crimp terminals. Ground (0.25 faston) tab standard.

Output Connector J2	
Pin	Single
1	+V1
2	+V1
3	RTN
4	RTN
5	N.C.
6	N.C.

J2 mates with Molex housing 43061-0006 & Molex series 5194 crimp terminals.

### Notes

- All dimensions in inches (mm). Tolerance .xx = ±0.02 (0.50); .xxx = ±0.01 (0.25)
- Cable harnesses with 300mm wire available.  
For single output models, order part number ECM40/60S LOOM.  
For multi-output models, order part number ECM40/60DT LOOM .
- Mating connector kit available. Order part number ECM40/60 CONKIT.
- Covers available. Order part number ECM40/60 COVER. Cover dimensions are 4.49 x 2.52 x 1.52 (114 x 64 x 38.5)
- † All accessories available from Farnell InOne.

## Thermal Considerations

To ensure correct and safe operation of the PSU, the temperature of the components listed in the table below must not be exceeded. See mechanical details for component locations.

Component	Maximum Temperature
L1	110 °C
T1	110 °C
CR2	120 °C
C4	95 °C

## Mechanical Details - Multi Output Models

Weight: approx. 0.33 lb (150g)

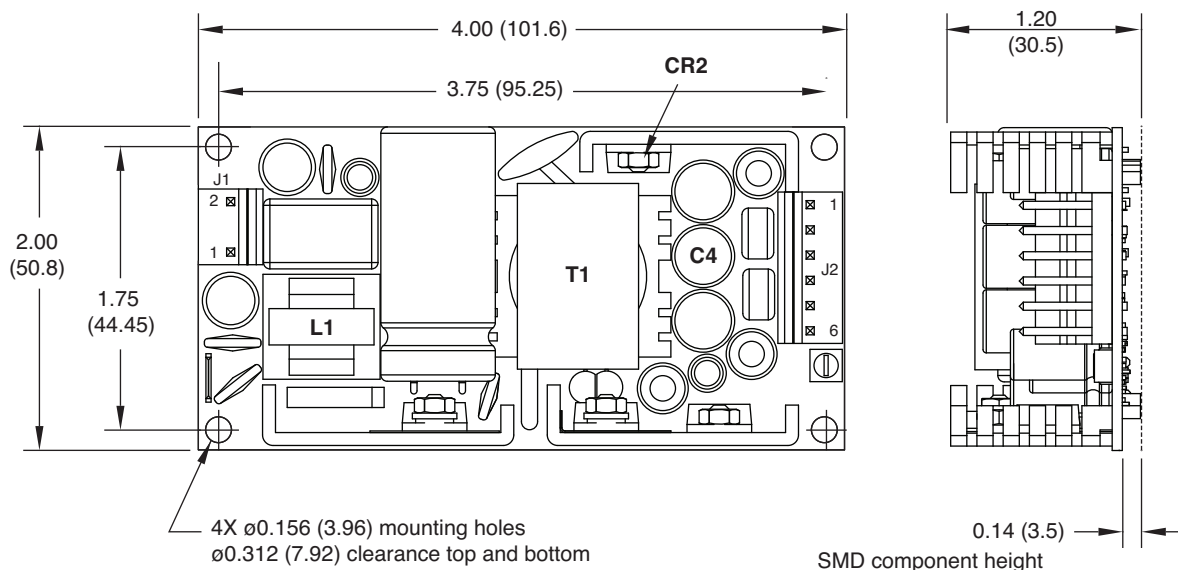

Input Connector J1	
Pin 1	Line
Pin 2	Neutral

J1 mates with Molex housing 43061-0003 and Molex series 5194 crimp terminals. Ground (0.25 faston) tab standard.

Output Connector J2	
Pin	Single
1	+V1
2	+V1
3	RTN
4	RTN
5	-V3
6	+V2

J2 mates with Molex housing 43061-0006 & Molex series 5194 crimp terminals.

### Notes

- All dimensions in inches (mm). Tolerance .xx = ±0.02 (0.50); .xxx = ±0.01 (0.25)
- Cable harnesses with 300mm wire available.  
For single output models, order part number ECM40/60S LOOM.  
For multi-output models, order part number ECM40/60DT LOOM .
- Mating connector kit available. Order part number ECM40/60 CONKIT.
- Covers available. Order part number ECM40/60 COVER. Cover dimensions are 4.49 x 2.52 x 1.52 (114 x 64 x 38.5)
- † All accessories available from Farnell InOne.

## Thermal Considerations

To ensure correct and safe operation of the PSU, the temperature of the components listed in the table below must not be exceeded. See mechanical details for component locations.

Component	Maximum Temperature
L1	110 °C
T1	110 °C
CR2	120 °C
C4	95 °C

# ECM100 Series

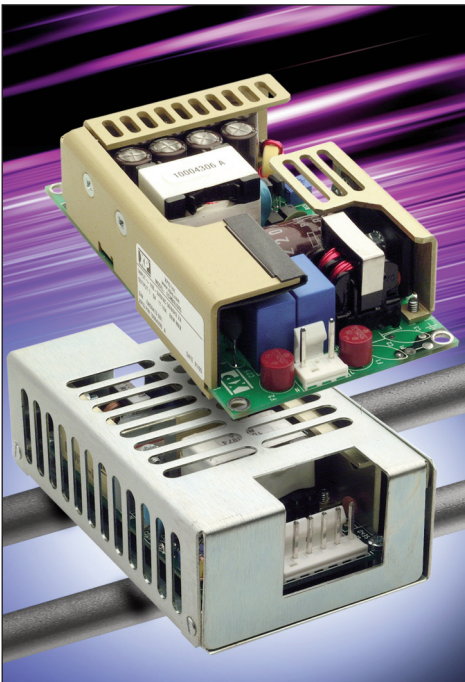

- 100 Watt Models
- Small Size 2.5" x 4.5" x 1.2"
- Low Leakage Current
- Industrial & Medical Approvals
- Convection & Force Cooled Ratings
- Wide Operating Temperature 0 °C to +70 °C
- Level B Conducted Emissions
- EN61000 Compliant
- Universal AC Input 90–264 VAC
- Input Frequency 47–63 & 440 Hz
- Cover Kits Available
- Mating Connector & Cable Harness Kits Available

Approved for Class I and Class II applications, the ECM100 range of single output AC-DC, 100 W power supplies from XP feature the world's smallest footprint for units of these ratings. Size is just 2.5" x 4.5" (63.5 mm x 114.3 mm) and 1.2" (30.48 mm) high. Furthermore, these high-density power supplies meet EN55032 Level B conducted emissions with maximum leakage currents of 125  $\mu$ A at 115 VAC or 210  $\mu$ A at 230 VAC. As a result, these switchers are equally suitable for industrial, IT and medical applications, with no price premium for meeting medical requirements.

The ECM100 series have single output versions from 3.3 V to 48 VDC, adjustable by  $\pm$ 10%. They are dual-fused for compliance with IEC60601-1 and efficiency is 80-85%, depending upon the model, so minimal excess heat is generated.

The power supplies deliver full power between 0 °C and +50 °C and will operate at up to +70 °C with derating and only 5 CFM of cooling. Comprehensive overvoltage, overload and short circuit protection is built in. Covers, cable harnesses and connector kits are available.

## Input Characteristics

Characteristic	Minimum	Typical	Maximum	Units	Notes & Conditions
Input Voltage - Operating	90		264	VAC	120-370 VDC
Input Frequency	47	50/60	63	Hz	400 Hz operation available
Power Factor		0.62			230 VAC
Input Current - No Load		40		mA	230 VAC
Input Current - Full Load		0.9		A	230 VAC
Inrush Current			40	A	230 VAC cold start
Earth Leakage Current			125/210	μA	115/230 VAC
Input Protection	T3.15 A/250 V internal fuse in both line and neutral				

## Output Characteristics

Characteristic	Minimum	Typical	Maximum	Units	Notes & Conditions
Output Voltage	3.3		48.0	VDC	See Models and Ratings Table
Initial Set Accuracy			V <sup>1</sup> : ±1. V <sup>2</sup> , V <sup>3</sup> & V <sup>4</sup> : ±5	%	
Output Voltage Adjustment	±5 ±10			%	3.3 & 5 V versions All other versions
Minimum Load				A	See model tables
Start Up Delay			1.5	s	90 VAC
Start Up Rise Time			50	ms	
Hold Up Time	16		75	ms	115-230 VAC input
Drift			±0.2	%	
Line Regulation			±0.5	%	90-264 VAC
Load Regulation			±1 V <sup>1</sup> & V <sup>2</sup> : ±1. V <sup>3</sup> & V <sup>4</sup> : ±5	%	Single output versions Multi output versions
Transient Response			4	%	Recovery to within 1% in less than 500 μs for a 25% load change
Ripple & Noise			1	%pk-pk	20 MHz bandwidth
Overvoltage Protection	115		135	%	V <sup>1</sup> only. Recycle input to reset
Overload Protection	110		170	%	Primary power limit, auto-recovery
Short Circuit Protection					Trip & restart (Hiccup mode)
Temperature Coefficient			0.05	%/°C	

## General Specifications

Characteristic	Minimum	Typical	Maximum	Units	Notes & Conditions
<b>Reliability and Service Life</b>					
<b>Isolation</b>					
Input to Output Test Voltage	4000			VAC	Test duration: 1 min
Input to Ground Test Voltage	1500			VAC	Test duration: 1 min
Output to Ground Test Voltage	500			VAC	Test duration: 1 min
<b>Other Specifications</b>					
Efficiency		80-85		%	See Efficiency Graphs
Switching Frequency		70		kHz	Fixed
Weight		0.4 (180)		lb (g)	
Power Density			7.40	W/in <sup>3</sup>	
MTBF		600		kHrs	MIL HDBK 217F

## Environmental

Characteristic	Minimum	Typical	Maximum	Units	Notes & Conditions
Operating Temperature	0		+70	°C	See derating curves
Storage Temperature	-40		+85	°C	
Cooling	5			CFM	For full power operation
Humidity			95	%RH	Non-condensing
Operating Altitude			3000	m	
Shock			30	G peak	Half sine 6 axis
Vibration			2	G rms	5 Hz to 500 Hz, 3 axis

## Electromagnetic Compatibility - Immunity

Phenomenon	Standard	Test Level	Criteria	Notes & Conditions
ESD	EN61000-4-2	3	A	
EFT	EN61000-4-4	3	A	
Radiated Field	EN61000-4-3	10 V/m	A	
Surges	EN61000-4-5	3	A	
Conducted	EN61000-4-6	10 Vrms	A	
Dips and Interruptions	EN61000-4-11 (Medical)	70% Ut	A	For 500 ms, Medical, 100% load
		40% Ut	A	For 100 ms, Medical, 60% load
		0% Ut	A	For 10 ms, Medical, 100% load
		0% Ut	B	For 5000 ms, Medical, 100% load
Dips and Interruptions	EN61000-4-11	70% Ut	A	For 10 ms, 100% load
		40% Ut	B	For 100 ms, 100% load
		<5% Ut	B	For 5000 ms, 100% load

## Electromagnetic Compatibility - Emissions

Phenomenon	Standard	Test Level	Criteria	Notes & Conditions
Conducted	EN55032/11	Class B		
Voltage Flicker	EN61000-3-3			
Harmonic Currents	EN61000-3-2	Class A		

## Safety Agency Approvals

Safety Agency	Safety Standard	Category
CB Report	IEC60950-1:2005 Ed 2 / IEC62368-1:2014	Information Technology
UL	UL 62368-1 & CAN/CSA C22.2 No. 62368-1-14	Information Technology
TUV	EN62368-1:2014/A11:2017	Information Technology
CE	LVD	

Safety Agency	Safety Standard	Category
CB Report	UL, IEC60601-1 Ed 3 Including Risk Management	Medical
UL	UL File # E146893, ANSI/AAMI ES 60601-1:2005 & CSA C22.2 No. 60601-1:08	Medical
TUV	EN60601-1:2006	Medical

Means of Protection		Category
Primary to Secondary (ECM100USxx Models)	2 x MOPP (Means of Patient Protection)	IEC60601-1 Ed 3
Primary to Secondary (ECM100UMxx Models)	1 x MOPP (Means of Patient Protection) Contact Sales for 2 x MOPP	
Primary to Earth	1 x MOPP (Means of Patient Protection)	

Equipment Protection Class	Safety Standard	Notes & Conditions
Class I & Class II	IEC60950-1:2005 Ed 2 / IEC62368-1:2014	See safety agency conditions of acceptability for details

## Models and Ratings

### Single Output Models

Output Voltage	Output Current Minimum	Output Current Maximum		Ripple & Noise	Model Number
		Convection cooled	5 CFM		
3.3 V	0.0 A	15.0 A	20.0 A	50 mV	ECM100US03
5.0 V	0.0 A	15.0 A	20.0 A	50 mV	ECM100US05
7.0 V	0.0 A	11.4 A	14.3 A	70 mV	ECM100US07
9.0 V	0.0 A	8.8 A	11.1 A	90 mV	ECM100US09
12.0 V	0.0 A	7.5 A	8.3 A	120 mV	ECM100US12
15.0 V	0.0 A	6.0 A	6.6 A	150 mV	ECM100US15
18.0 V	0.0 A	5.0 A	5.5 A	180 mV	ECM100US18
24.0 V	0.0 A	4.1 A	4.1 A	240 mV	ECM100US24
28.0 V	0.0 A	3.6 A	3.6 A	280 mV	ECM100US28
33.0 V	0.0 A	3.0 A	3.0 A	330 mV	ECM100US33
48.0 V	0.0 A	2.1 A	2.1 A	480 mV	ECM100US48

### Multi Output Models

Power Max Convection	Power Max 5 CFM	Output 1	Imin/Imax	Output 2	Imin/Imax	Output 3	Imin/Imax	Output 4	Imin/Imax	Model Number
80 W	100 W	+5.0V	0.0 A/12 A	+12.0V	0.00 A / 3.0 A					ECM100UD21
80 W	100 W	+5.0V	0.0 A/12 A	+15.0V	0.00 A / 3.0 A					ECM100UD22
75 W	100 W	+5.0V	0.5 A/10 A	+12.0V	0.00 A / 3.0 A	-12.0V	0.0 A / 0.8 A			ECM100UT31
80 W	100 W	+5.0V	0.5 A/10 A	+24.0V	0.00 A / 2.0 A	-12.0V	0.0 A / 0.8 A			ECM100UT32
80 W	100 W	+5.0V	0.5 A/10 A	+15.0V	0.00 A / 3.0 A	-15.0V	0.0 A / 0.8 A			ECM100UT33
65 W	100 W	+3.3V	0.5 A/10 A	+5.0V	0.00 A / 5.0 A	+12.0V	0.0 A / 0.8 A			ECM100UT34
70 W	100 W	+5.0V	0.5 A/10 A	+3.3V	0.00 A / 5.0 A	+12.0V	0.0 A / 0.8 A			ECM100UT35
80 W	100 W	+5.0V	0.5 A/10 A	+12.0V	0.00 A / 3.0 A	-5.0V	0.0 A / 0.8 A			ECM100UT36
70 W	100 W	+5.0V	0.5 A/10 A	+15.0V	0.00 A / 3.0 A	-5.0V	0.0 A / 0.8 A			ECM100UT37
65 W	100 W	+5.0V	0.5 A/10 A	+3.3V	0.10 A / 5.0 A	+12.0V	0.0 A / 0.8 A	-12.0V	0.0 A / 0.5 A	ECM100UQ41
60 W	100 W	+3.3V	0.5 A/10 A	+5.0V	0.10 A / 5.0 A	+12.0V	0.0 A / 0.8 A	-12.0V	0.0 A / 0.5 A	ECM100UQ42
80 W	100 W	+5.0V	0.5 A/10 A	+24.0V	0.10 A / 2.0 A	+12.0V	0.0 A / 0.8 A	-12.0V	0.0 A / 0.5 A	ECM100UQ43
80 W	100 W	+5.0V	0.5 A/10 A	+24.0V	0.10 A / 2.0 A	+15.0V	0.0 A / 0.8 A	-15.0V	0.0 A / 0.5 A	ECM100UQ44
80 W	100 W	+5.0V	0.5 A/10 A	+12.0V	0.10 A / 3.0 A	-12.0V	0.0 A / 0.8 A	-5.0V	0.0 A / 0.5 A	ECM100UQ45
80 W	100 W	+5.0V	0.5 A/10 A	+15.0V	0.10 A / 3.0 A	-15.0V	0.0 A / 0.8 A	-5.0V	0.0 A / 0.5 A	ECM100UQ46

### Notes

1. To receive unit with cover fitted, add suffix '-C' to model number.

2. Output 3 available with opposite polarity for OEM quantities.

## Derating Curves

All ECM100 single output models convection cooled

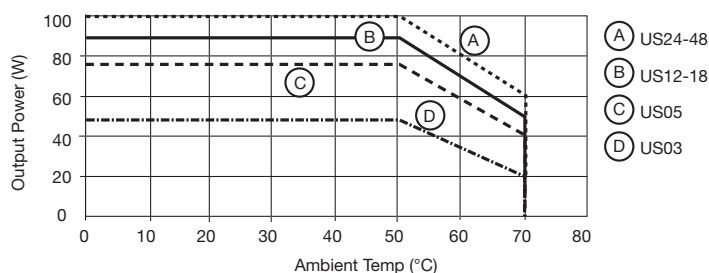

### Note:

1. Derate by 10% if cover is fitted.
2. For multi output convection-cooled operation above 50 °C derate linearly to 50% at 70 °C.

All ECM100 models with 5 CFM

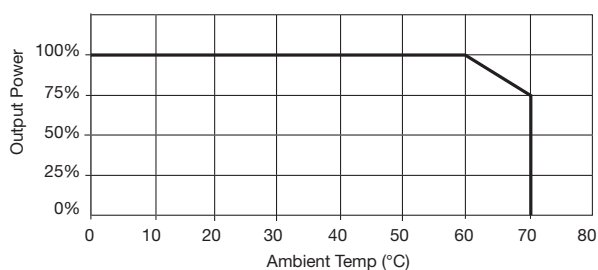



## Transient Response

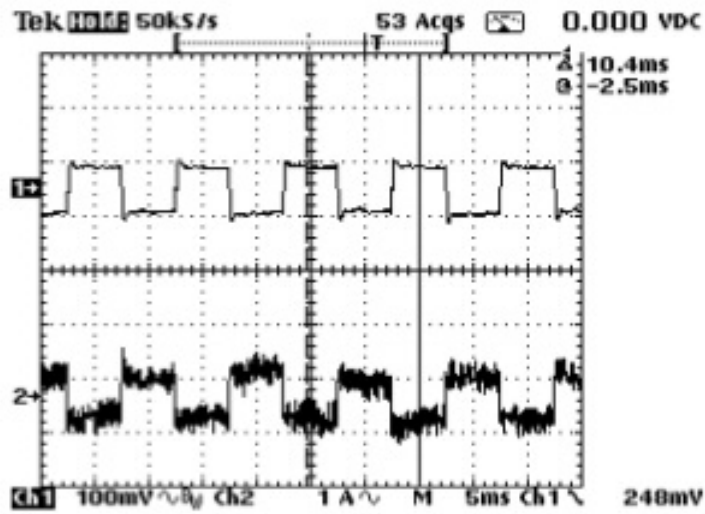

ECM100US24 25% load change

## Efficiency Versus Input Voltage

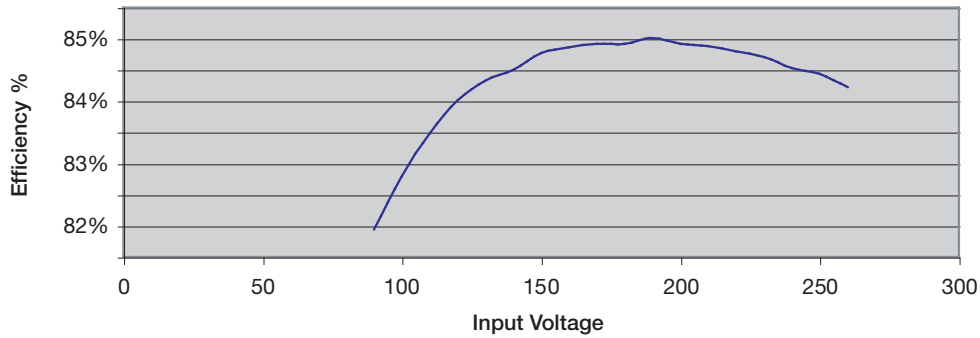

Efficiency shown for ECM100US24

## Efficiency Versus Output Load

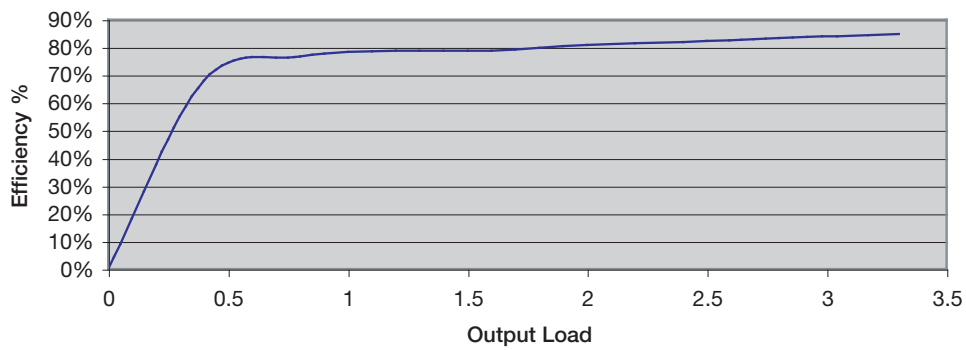

Efficiency shown for ECM100US24

### Start Up Delay

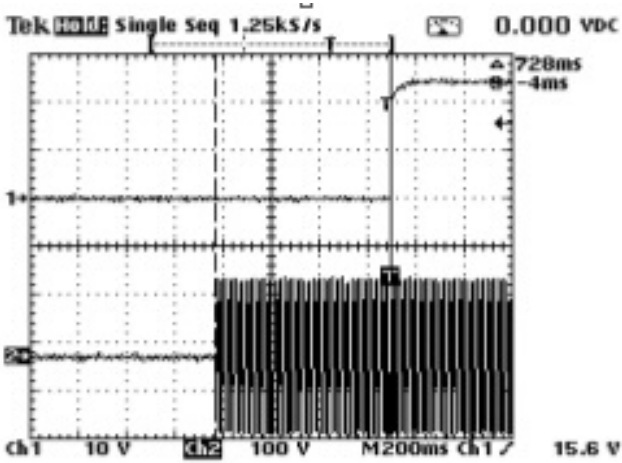

ECM100US24 start up 115 VAC at 100% load

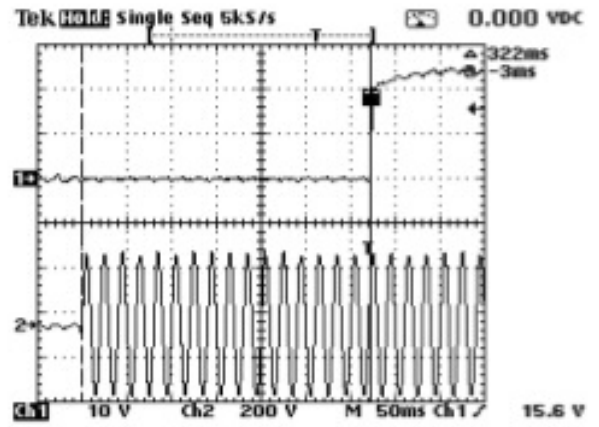

ECM100US24 start up 230 VAC at 100% load

### Hold Up Time

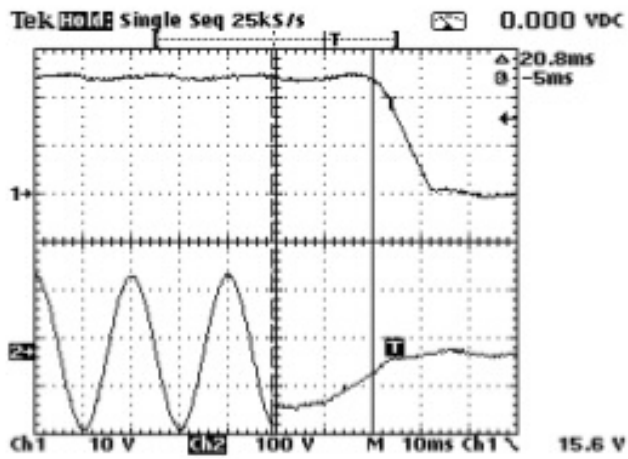

ECM100US24 hold up 115 VAC at 100% load  
Hold up time is 20.8 ms

### Overload Characteristics

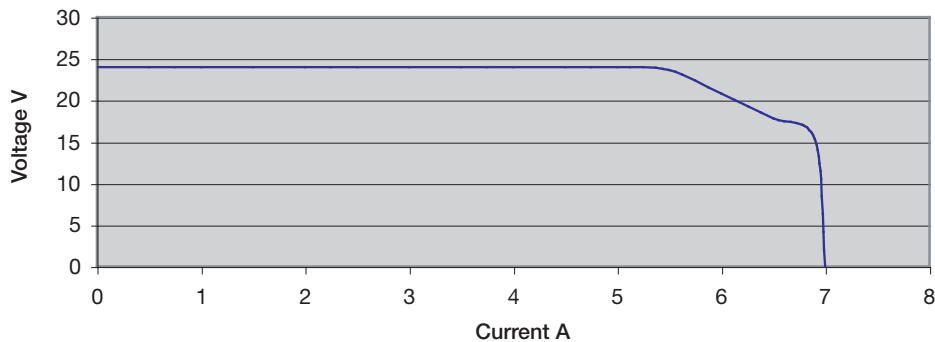

ECM100US24. When current reaches 6.9 A, output goes into trip & restart (Hiccup mode)

## Output Ripple & Noise

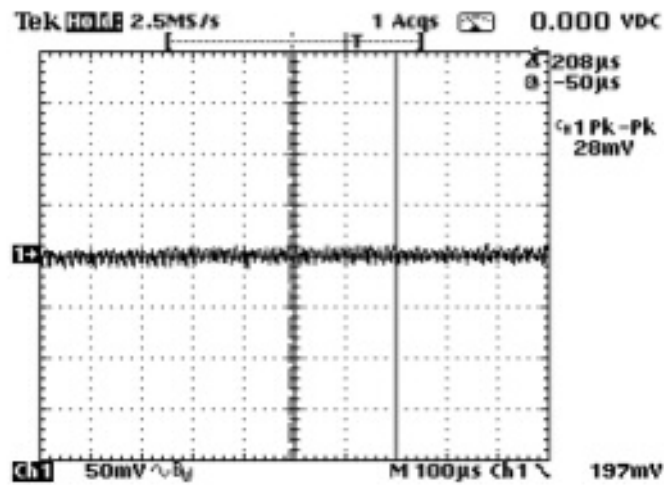

ECM100US24 with 100 W load  
Noise measured is 28 mV

## Conducted Noise

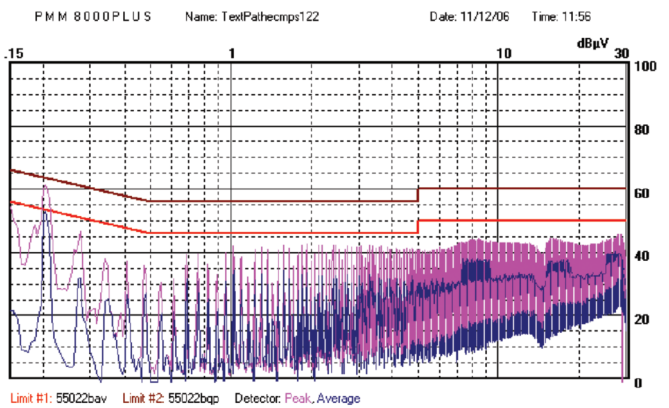

ECM100US12 Class I - Output floating (full load)

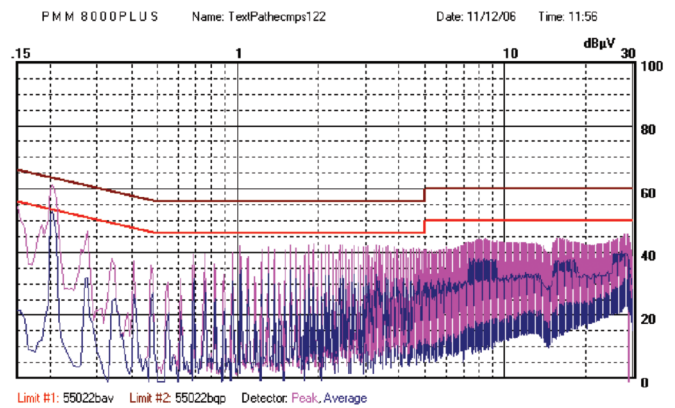

ECM100UQ44 Class I - Output floating (full load)

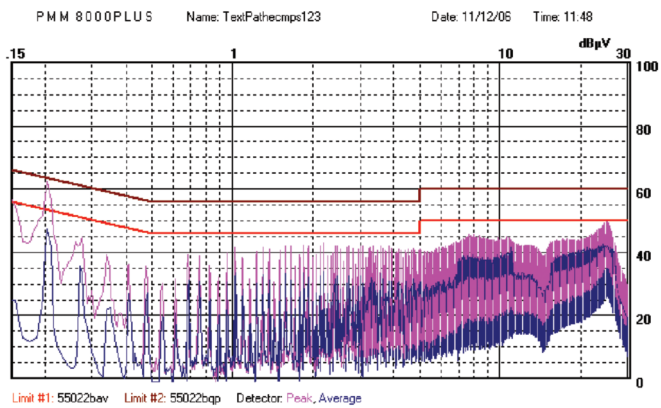

ECM100US12 Class I - Output grounded (full load)

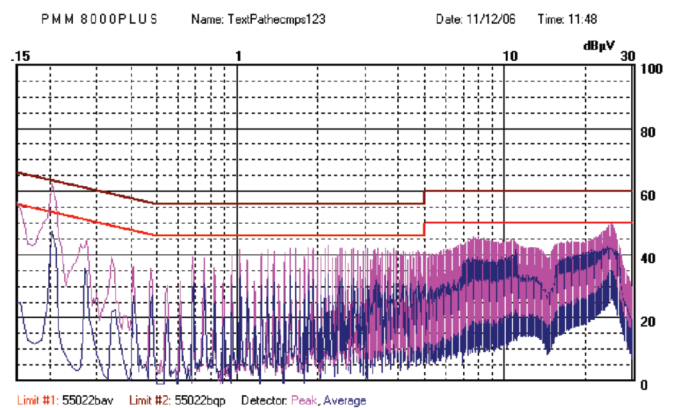

ECM100UQ44 Class I - Output grounded (full load)

## Mechanical Details - Single Output Models

Weight: approx. 0.4 lb (180g)

Cover dimensions are 4.98 x 3.01 x 1.54 (126.5 x 76.4 x 39.0)

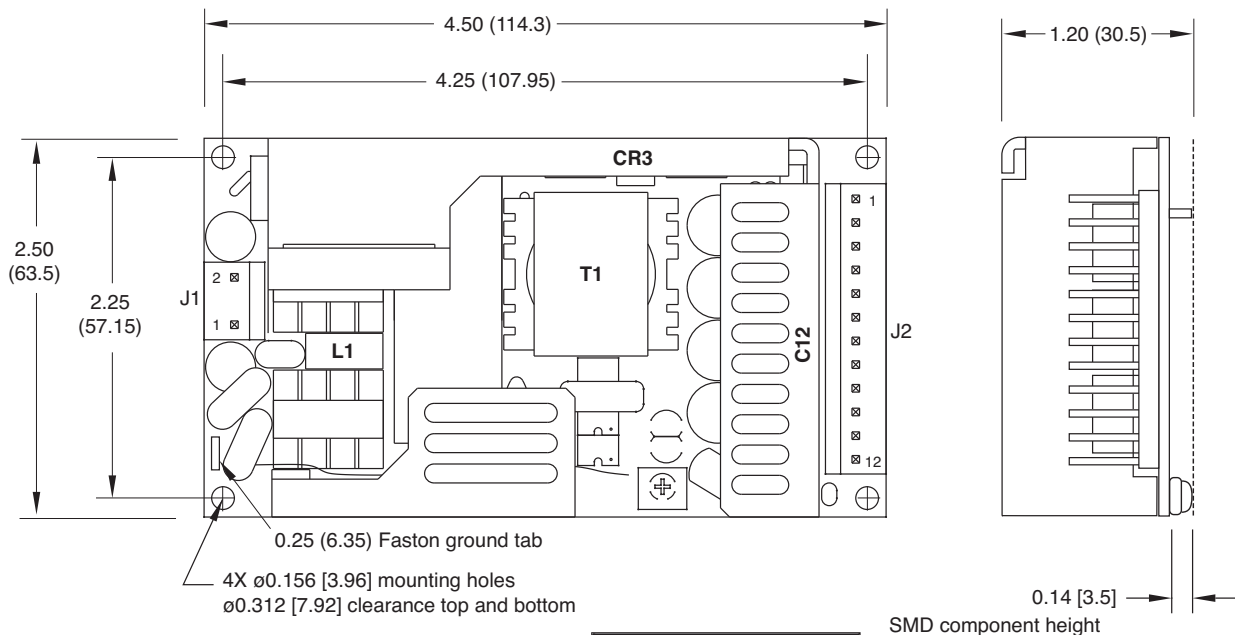

Input Connector J1	
Pin 1	Line
Pin 2	Neutral

J1 mates with Molex housing 43061-0003 and Molex series 5194 crimp terminals. Ground (0.25 faston) tab standard.

Output Connector J2	
Pin	Single
1	+V1
2	+V1
3	+V1
4	+V1
5	V1 RTN
6	V1 RTN
7	V1 RTN
8	V1 RTN
9	NOT USED
10	NOT USED
11	NOT USED
12	NOT USED

SMD component height

J2 mates with Molex housing 43061-0012 & Molex series 5194 crimp terminals

### Notes

1. All dimensions in inches (mm). Tolerance .xx = ±0.02 (0.50); .xxx = ±0.01 (0.25)
2. Cable harnesses with 300mm wire available. For single output models, order part number ECM100S LOOM.
3. Mating connector kit available. Order part number ECM100 CONKIT.
4. Covers available. Order part number ECM100 COVER.

## Thermal Considerations

To ensure correct and safe operation of the PSU, the temperature of the components listed in the table below must not be exceeded. See mechanical details for component locations.

Component	Maximum Temperature
L1	110 °C
T1	110 °C
CR3	120 °C
C12	95 °C

## Mechanical Details - Multi Output Models

Weight: approx. 0.4 lb (180g)

Cover dimensions are 4.98 x 3.01 x 1.54 (126.5 x 76.4 x 39.0)

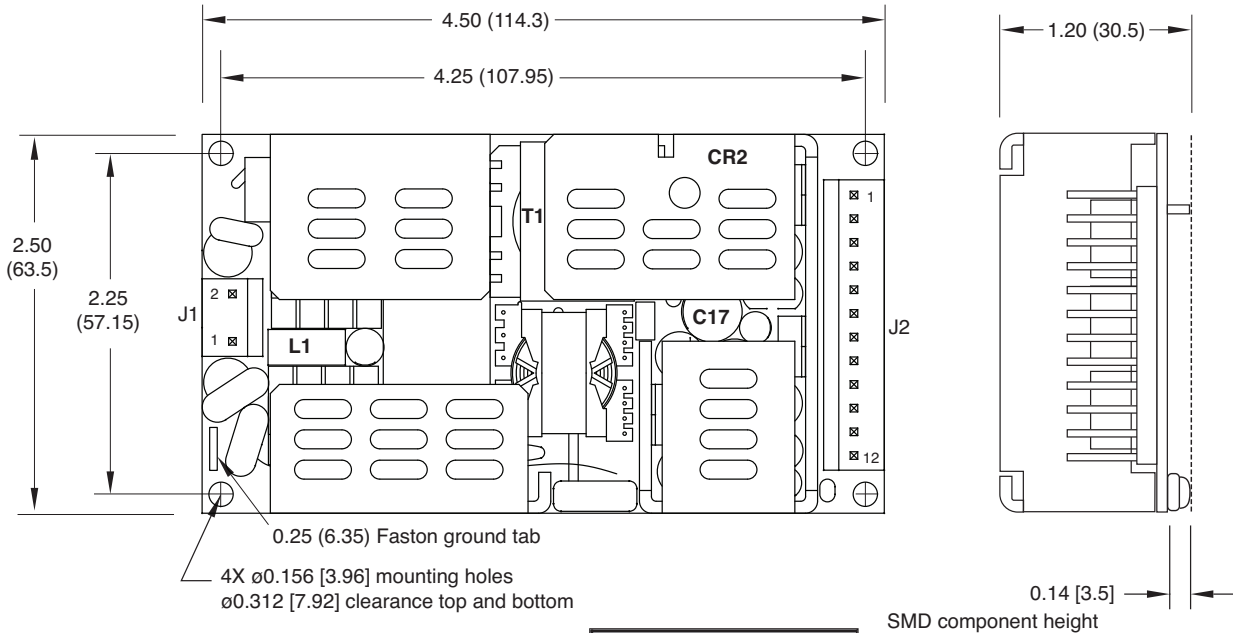

Input Connector J1	
Pin 1	Line
Pin 2	Neutral

J1 mates with Molex housing 43061-0003 and Molex series 5194 crimp terminals. Ground (0.25 faston) tab standard.

Output Connector J2	
Pin	Multi
1	+V1
2	+V1
3	+V1
4	+V1
5	RTN
6	RTN
7	RTN
8	RTN
9	+V2
10	+V2
11	±V3
12	-V4

J2 mates with Molex Housing 43061-0012 and Molex series 5194 crimp terminals

### Notes

1. All dimensions in inches (mm). Tolerance .xx = ±0.02 (0.50); .xxx = ±0.01 (0.25)
2. Cable harness with 300mm wire available. For multi output models (dual and triple output only), order part number ECM100DT LOOM.
3. Mating connector kit available. Order part number ECM100 CONKIT.
4. Covers available. Order part number ECM100 COVER.

## Thermal Considerations

To ensure correct and safe operation of the PSU, the temperature of the components listed in the table below must not be exceeded. See mechanical details for component locations.

Component	Maximum Temperature
L1	110 °C
T1	110 °C
CR2	120 °C
C17	95 °C