

## BACKUP-BATTERY SUPERVISORS FOR RAM RETENTION

### FEATURES

- Supply Current of 40  $\mu$ A (Max)
- Battery-Supply Current of 100 nA (Max)
- Precision Supply Voltage Monitor 3.3 V, 5 V, Other Options on Request
- Backup-Battery Voltage Can Exceed  $V_{DD}$
- Power On Reset Generator With Fixed 100-ms Reset Delay Time
- Voltage Monitor For Power-Fail or Low-Battery Monitoring
- Battery Freshness Seal (TPS3619)
- Pin-For-Pin Compatible With MAX819, MAX703, and MAX704
- 8-Pin MSOP Package
- Temperature Range  $-40^{\circ}\text{C}$  to  $+85^{\circ}\text{C}$

### APPLICATIONS

- Fax Machines
- Set-Top Boxes
- Advanced Voice Mail Systems
- Portable Battery-Powered Equipment
- Computer Equipment
- Advanced Modems
- Automotive Systems
- Portable Long-Time Monitoring Equipment
- Point-of-Sale Equipment

### DESCRIPTION

The TPS3619 and TPS3620 families of supervisory circuits monitor and control processor activity by providing backup-battery switchover for data retention of CMOS RAM.

During power on,  $\overline{\text{RESET}}$  is asserted when the supply voltage ( $V_{DD}$  or  $V_{BAT}$ ) becomes higher than 1.1 V. Thereafter, the supply voltage supervisor monitors  $V_{DD}$  and keeps  $\overline{\text{RESET}}$  output active as long as  $V_{DD}$  remains below the threshold voltage ( $V_{IT}$ ). An internal timer delays the return of the output to the inactive state (high) to ensure proper system reset. The delay time starts after  $V_{DD}$  has risen above  $V_{IT}$ . When the supply voltage drops below  $V_{IT}$ , the output becomes active (low) again.

The product spectrum is designed for supply voltages of 3.3 V and 5 V. The TPS3619 and TPS3620 are available in an 8-pin MSOP package and are characterized for operation over a temperature range of  $-40^{\circ}\text{C}$  to  $+85^{\circ}\text{C}$ .

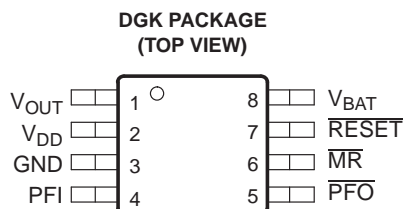

  
ACTUAL SIZE  
3,05 mm x 4,98 mm

### TYPICAL OPERATING CIRCUIT

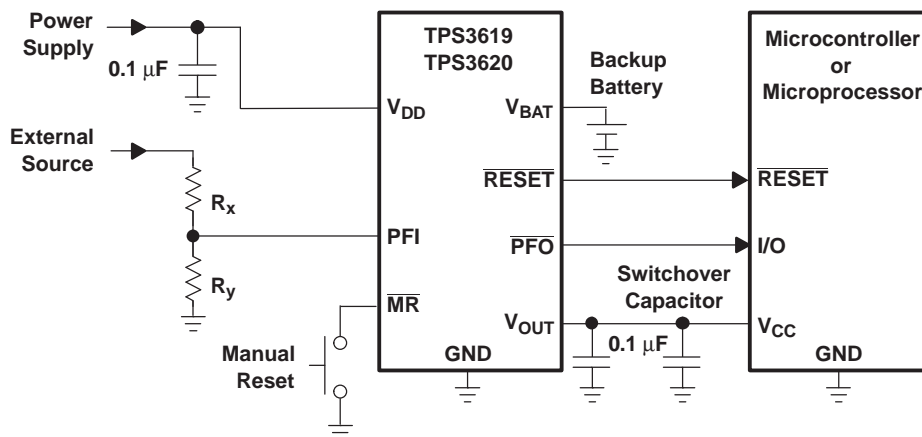

Please be aware that an important notice concerning availability, standard warranty, and use in critical applications of Texas Instruments semiconductor products and disclaimers thereto appears at the end of this data sheet.

All trademarks are the property of their respective owners.



This integrated circuit can be damaged by ESD. Texas Instruments recommends that all integrated circuits be handled with appropriate precautions. Failure to observe proper handling and installation procedures can cause damage.

ESD damage can range from subtle performance degradation to complete device failure. Precision integrated circuits may be more susceptible to damage because very small parametric changes could cause the device not to meet its published specifications.

### PACKAGE INFORMATION<sup>(1)</sup>

| PRODUCT    | SPECIFIED TEMPERATURE RANGE | PACKAGE MARKING | ORDERING NUMBER     | TRANSPORT MEDIA, QUANTITY |
|------------|-----------------------------|-----------------|---------------------|---------------------------|
| TPS3619-33 | -40°C to +85°C              | AFL             | TPS3619-33DGK       | Tube, 80                  |
|            |                             |                 | TPS3619-33DGKR      | Tape and Reel, 2500       |
| AFM        |                             | TPS3619-50DGK   | Tube, 80            |                           |
|            |                             | TPS3619-50DGKR  | Tape and Reel, 2500 |                           |
| TPS3620-33 |                             | ANL             | TPS3620-33DGKT      | Tape and Reel, 250        |
|            |                             |                 | TPS3620-33DGKR      | Tape and Reel, 2500       |
| TPS3620-50 | ANM                         | TPS3620-50DGKT  | Tape and Reel, 250  |                           |
|            |                             | TPS3620-50DGKR  | Tape and Reel, 2500 |                           |

(1) For the most current specifications and package information, see the Package Option Addendum located at the end of this data sheet or refer to our web site at [www.ti.com](http://www.ti.com).

### STANDARD AND APPLICATION SPECIFIC VERSIONS

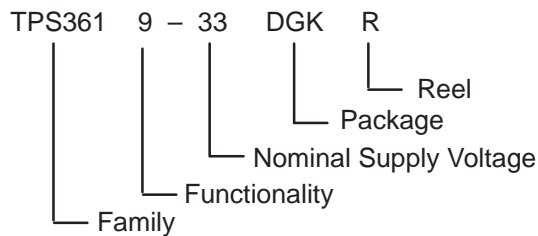

| DEVICE NAME    | NOMINAL VOLTAGE <sup>(1)</sup> , V <sub>NOM</sub> |
|----------------|---|
| TPS3619-33 DGK | 3.3 V   |
| TPS3619-50 DGK | 5.0 V   |
| TPS3620-33 DGK | 3.3 V   |
| TPS3620-50 DGK | 5.0 V   |

(1) For other threshold voltage versions, contact the local TI sales office for availability and lead-time.

### ABSOLUTE MAXIMUM RATINGS

Over operating free-air temperature (unless otherwise noted).<sup>(1)</sup>

|  |   | UNIT                                |
|--|---|-------------------------------------|
| Supply voltage:  | V <sub>DD</sub> <sup>(2)</sup>                | 7 V                                 |
|  | $\overline{MR}$ and PFI pins <sup>(2)</sup>   | -0.3 V to (V <sub>DD</sub> + 0.3 V) |
| Continuous output current:   | V <sub>OUT</sub> , I <sub>O</sub>             | 400 mA                              |
|  | All other pins, I <sub>O</sub> <sup>(2)</sup> | ±10 mA                              |
| Continuous total power dissipation                                     |   | See Dissipation Rating Table        |
| Operating free-air temperature range, T <sub>A</sub>                   |   | -40°C to +85°C                      |
| Storage temperature range, T <sub>stg</sub>                            |   | -65°C to +150°C                     |
| Lead temperature soldering 1,6 mm (1/16 inch) from case for 10 seconds |   | +260°C                              |

(1) Stresses beyond those listed under *absolute maximum ratings* may cause permanent damage to the device. These are stress ratings only, and functional operation of the device at these or any other conditions beyond those indicated under recommended operating conditions is not implied. Exposure to absolute-maximum-rated conditions for extended periods may affect device reliability.

(2) All voltage values are with respect to GND. For reliable operation, the device must not be operated at 7 V for more than t = 1000h continuously.

### DISSIPATION RATING TABLE

| PACKAGE | θ <sub>JC</sub> | θ <sub>JA</sub><br>(LOW-K) | θ <sub>JA</sub><br>(HIGH-K) | T <sub>A</sub> < 25°C<br>POWER RATING | DERATING<br>FACTOR ABOVE<br>T <sub>A</sub> = +25°C | T <sub>A</sub> = +70°C<br>POWER RATING | T <sub>A</sub> = +85°C<br>POWER RATING |
|---------|-----------------|----------------------------|-----------------------------|---------------------------------------|--|--|--|
| DGK     | 55°C/W          | 266°C/W                    | 180°C/W                     | 470 mW                                | 3.76 mW/°C   | 301 mW                                 | 241 mW                                 |

## RECOMMENDED OPERATING CONDITIONS

At specified temperature range.

|  | MIN                 | MAX                 | UNIT         |
|--|---------------------|---------------------|--------------|
| Supply voltage, $V_{DD}$                                 | 1.65                | 5.5                 | V            |
| Battery supply voltage, $V_{BAT}$                        | 1.5                 | 5.5                 | V            |
| Input voltage, $V_I$                                     | 0                   | $V_{DD} + 0.3$      | V            |
| High-level input voltage, $V_{IH}$                       | $0.7 \times V_{DD}$ |                     | V            |
| Low-level input voltage, $V_{IL}$                        |                     | $0.3 \times V_{DD}$ | V            |
| Continuous output current at $V_{OUT}$ , $I_O$           |                     | 300                 | mA           |
| Input transition rise and fall rate at $\overline{MR}$   |                     | 100                 | ns/V         |
| Slew rate at $V_{DD}$ or $V_{BAT}$ , $\Delta t/\Delta V$ |                     | 1                   | V/ $\mu$ s   |
| Operating free-air temperature range, $T_A$              | -40                 | +85                 | $^{\circ}$ C |

## ELECTRICAL CHARACTERISTICS

Over recommended operating conditions (unless otherwise noted).

| PARAMETER    |  |                                     | TEST CONDITIONS  | MIN                | TYP  | MAX | UNIT     |
|--------------|--|-------------------------------------|--|--------------------|------|-----|----------|
| $V_{OH}$     | High-level output voltage                                    | $\overline{RESET}$                  | $V_{DD} = 1.8$ V, $I_{OH} = -400$ $\mu$ A                    | $V_{DD} - 0.2$ V   |      |     | V        |
|              |  |                                     | $V_{DD} = 3.3$ V, $I_{OH} = -2$ mA                           | $V_{DD} - 0.4$ V   |      |     |          |
|              |  |                                     | $V_{DD} = 5$ V, $I_{OH} = -3$ mA                             | $V_{DD} - 0.4$ V   |      |     |          |
|              |  | $\overline{PFO}$                    | $V_{DD} = 1.8$ V, $I_{OH} = -20$ $\mu$ A                     | $V_{DD} - 0.3$ V   |      |     | V        |
|              |  |                                     | $V_{DD} = 3.3$ V, $I_{OH} = -80$ $\mu$ A                     | $V_{DD} - 0.4$ V   |      |     |          |
|              |  |                                     | $V_{DD} = 5$ V, $I_{OH} = -120$ $\mu$ A                      | $V_{DD} - 0.4$ V   |      |     |          |
| $V_{OL}$     | Low-level output voltage                                     | $\overline{RESET}$ $\overline{PFO}$ | $V_{DD} = 1.8$ V, $I_{OL} = -400$ $\mu$ A                    |                    |      | 0.2 | V        |
|              |  |                                     | $V_{DD} = 3.3$ V, $I_{OL} = 2$ mA                            |                    |      | 0.4 |          |
|              |  |                                     | $V_{DD} = 5$ V, $I_{OL} = 3$ mA                              |                    |      | 0.4 |          |
| $V_{res}$    | Power-up reset voltage (see <sup>(1)</sup> )                 |                                     | $I_{OL} = 20$ $\mu$ A, $V_{BAT} > 1.1$ V or $V_{DD} > 1.1$ V |                    |      | 0.4 | V        |
| $V_{OUT}$    | Normal mode  |                                     | $I_{OUT} = 8.5$ mA, $V_{BAT} = 0$ V, $V_{DD} = 1.8$ V        | $V_{DD} - 50$ mV   |      |     | V        |
|              |  |                                     | $I_{OUT} = 125$ mA, $V_{BAT} = 0$ V, $V_{DD} = 3.3$ V        | $V_{DD} - 150$ mV  |      |     |          |
|              |  |                                     | $I_{OUT} = 200$ mA, $V_{BAT} = 0$ V, $V_{DD} = 5$ V          | $V_{DD} - 200$ mV  |      |     |          |
|              | Battery-backup mode  |                                     | $I_{OUT} = 0.5$ mA, $V_{BAT} = 1.5$ V, $V_{DD} = 0$ V        | $V_{BAT} - 20$ mV  |      |     | V        |
|              |  |                                     | $I_{OUT} = 7.5$ mA, $V_{BAT} = 3.3$ V, $V_{DD} = 0$ V        | $V_{BAT} - 113$ mV |      |     |          |
| $r_{DS(on)}$ | $V_{DD}$ to $V_{OUT}$ on-resistance                          |                                     | $V_{DD} = 5$ V   |                    | 0.6  | 1   | $\Omega$ |
|              | $V_{BAT}$ to $V_{OUT}$ on-resistance                         |                                     | $V_{DD} = 3.3$ V   |                    | 8    | 15  |          |
| $V_{IT-}$    | Negative-going input threshold voltage (see <sup>(2)</sup> ) | TPS3619-33                          | $T_A = -40^{\circ}$ C to $85^{\circ}$ C                      | 2.88               | 2.93 | 3   | V        |
| TPS3619-50   |  | 4.46                                |  | 4.55               | 4.64 |     |          |
| PFI          |  | 1.13                                |  | 1.15               | 1.17 |     |          |
| $V_{hys}$    | Hysteresis   | $V_{IT}$                            | $1.65$ V $< V_{IT} < 2.5$ V                                  |                    | 20   |     | mV       |
|              |  |                                     | $2.5$ V $< V_{IT} < 3.5$ V                                   |                    | 40   |     |          |
|              |  |                                     | $3.5$ V $< V_{IT} < 5.5$ V                                   |                    | 60   |     |          |
|              |  | PFI                                 |  | 12                 |      |     |          |
|              |  | VBSW (see <sup>(3)</sup> )          | $V_{DD} = 1.8$ V   |                    | 55   |     |          |

 (1) The lowest supply voltage at which RESET becomes active.  $t_{r,VDD} \geq 15$   $\mu$ s/V.

 (2) To ensure the best stability of the threshold voltage, a bypass capacitor (ceramic, 0.1  $\mu$ F) should be placed near the supply terminals.

 (3) For  $V_{DD} < 1.6$  V,  $V_{OUT}$  switches to  $V_{BAT}$  regardless of  $V_{BAT}$ .

## ELECTRICAL CHARACTERISTICS (continued)

Over recommended operating conditions (unless otherwise noted).

| PARAMETER   |                          |                  | TEST CONDITIONS                     |                         | MIN  | TYP  | MAX  | UNIT          |
|-------------|--------------------------|------------------|-------------------------------------|-------------------------|------|------|------|---------------|
| $I_{IH}$    | High-level input current | $\overline{MR}$  | $\overline{MR} = 0.7 \times V_{DD}$ | $V_{DD} = 5\text{ V}$   | -33  |      | -76  | $\mu\text{A}$ |
| $I_{IL}$    | Low-level input current  |                  | $\overline{MR} = 0\text{ V}$        |                         | -110 | -255 |      |               |
| $I_i$       | Input current            | PFI              |                                     |                         | -25  |      | 25   | nA            |
| $I_{OS}$    | Short-circuit current    | $\overline{PFO}$ | $\overline{PFO} = 0\text{ V}$       | $V_{DD} = 1.8\text{ V}$ |      |      | -0.3 | mA            |
|             |                          |                  |                                     | $V_{DD} = 3.3\text{ V}$ |      |      | -1.1 |               |
|             |                          |                  |                                     | $V_{DD} = 5\text{ V}$   |      |      | -2.4 |               |
| $I_{DD}$    | $V_{DD}$ supply current  |                  | $V_{OUT} = V_{DD}$                  |                         |      |      | 40   | $\mu\text{A}$ |
|             |                          |                  | $V_{OUT} = V_{BAT}$                 |                         |      |      | 40   |               |
| $I_{(BAT)}$ | $V_{BAT}$ supply current |                  | $V_{OUT} = V_{DD}$                  |                         | -0.1 |      | 0.1  | $\mu\text{A}$ |
|             |                          |                  | $V_{OUT} = V_{BAT}$                 |                         |      |      | 0.5  |               |
| $C_i$       | Input capacitance        |                  | $V_i = 0\text{ V to } 5\text{ V}$   |                         |      | 5    |      | pF            |

## TIMING REQUIREMENTS

At  $R_L = 1\text{ M}\Omega$ ,  $C_L = 50\text{ pF}$ ,  $T_A = -40^\circ\text{C to } +85^\circ\text{C}$ .

| PARAMETER |             |                    | TEST CONDITIONS  |  | MIN | TYP | MAX | UNIT          |
|-----------|-------------|--------------------|--|--|-----|-----|-----|---------------|
| $t_w$     | Pulse width | at $V_{DD}$        | $V_{IH} = V_{IT} + 0.2\text{ V}$ , $V_{IL} = V_{IT} - 0.2\text{ V}$                            |  | 6   |     |     | $\mu\text{s}$ |
|           |             | at $\overline{MR}$ | $V_{DD} = V_{IT} + 0.2\text{ V}$ , $V_{IL} = 0.3 \times V_{DD}$ , $V_{IH} = 0.7 \times V_{DD}$ |  | 100 |     |     | ns            |

## SWITCHING CHARACTERISTICS

At  $R_L = 1\text{ M}\Omega$ ,  $C_L = 50\text{ pF}$ ,  $T_A = -40^\circ\text{C to } +85^\circ\text{C}$ .

| PARAMETER |  |                                       | TEST CONDITIONS  |  | MIN | TYP | MAX | UNIT          |
|-----------|--|---------------------------------------|--|--|-----|-----|-----|---------------|
| $t_d$     | Delay time   |                                       | $V_{DD} \geq V_{IT} + 0.2\text{ V}$ , $\overline{MR} \geq 0.7 \times V_{DD}$<br>See <a href="#">timing diagram</a> |  | 60  | 100 | 140 | ms            |
| $t_{PHL}$ | Propagation (delay) time, high-to-low level output | $V_{DD}$ to $\overline{RESET}$        | $V_{IL} = V_{IT} - 0.2\text{ V}$ , $V_{IH} = V_{IT} + 0.2\text{ V}$  |  |     | 2   | 5   | $\mu\text{s}$ |
|           |  | PFI to $\overline{PFO}$ delay         | $V_{IL} = V_{PFI} - 0.2\text{ V}$ , $V_{IH} = V_{PFI} + 0.2\text{ V}$  |  |     | 3   | 5   |               |
|           |  | $\overline{MR}$ to $\overline{RESET}$ | $V_{DD} \geq V_{IT} + 0.2\text{ V}$ , $V_{IL} = 0.3 \times V_{DD}$ ,<br>$V_{IH} = 0.7 \times V_{DD}$               |  |     | 0.1 | 1   |               |

**TIMING DIAGRAM**

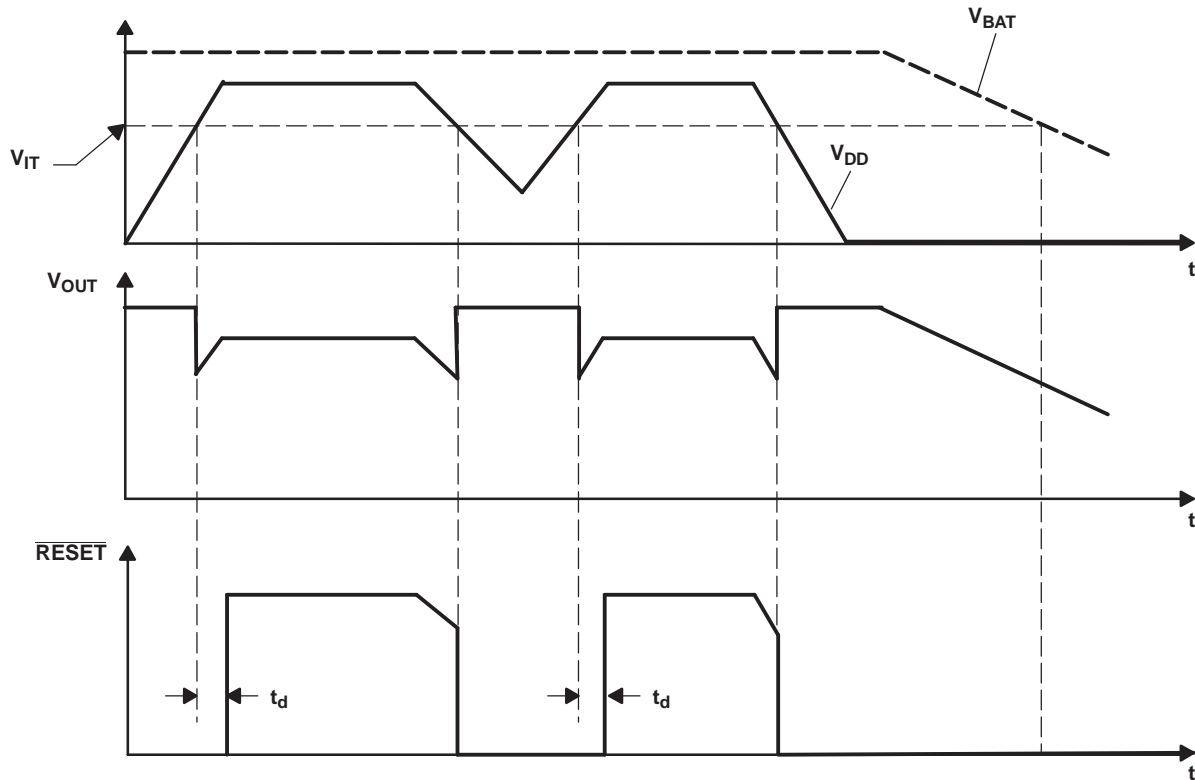

**Table 1. FUNCTION TABLE**

| $V_{DD} > V_{IT}$ | $V_{DD} > V_{BAT}$ | $\overline{MR}$ | $V_{OUT}$ | $\overline{RESET}$ |
|-------------------|--------------------|-----------------|-----------|--------------------|
| 0                 | 0                  | 0               | $V_{BAT}$ | 0                  |
| 0                 | 0                  | 1               | $V_{BAT}$ | 0                  |
| 0                 | 1                  | 0               | $V_{DD}$  | 0                  |
| 0                 | 1                  | 1               | $V_{DD}$  | 0                  |
| 1                 | 0                  | 0               | $V_{DD}$  | 0                  |
| 1                 | 0                  | 1               | $V_{DD}$  | 1                  |
| 1                 | 1                  | 0               | $V_{DD}$  | 0                  |
| 1                 | 1                  | 1               | $V_{DD}$  | 1                  |

| $PFI > V_{PFI}$ | $PFO$ |
|-----------------|-------|
| 0               | 0     |
| 1               | 1     |

CONDITION.:  $V_{DD} > V_{DD\_MIN}$

Table 2. TERMINAL FUNCTIONS

| TERMINAL                  |     | I/O | DESCRIPTION                  |
|---------------------------|-----|-----|------------------------------|
| NAME                      | NO. |     |                              |
| GND                       | 3   | I   | Ground                       |
| $\overline{\text{MR}}$    | 6   | I   | Manual reset input           |
| PFI                       | 4   | I   | Power-fail comparator input  |
| $\overline{\text{PFO}}$   | 5   | O   | Power-fail comparator output |
| $\overline{\text{RESET}}$ | 7   | O   | Active-low reset output      |
| $V_{\text{BAT}}$          | 8   | I   | Backup-battery input         |
| $V_{\text{DD}}$           | 2   | I   | Input supply voltage         |
| $V_{\text{OUT}}$          | 1   | O   | Supply output                |

FUNCTIONAL BLOCK DIAGRAM

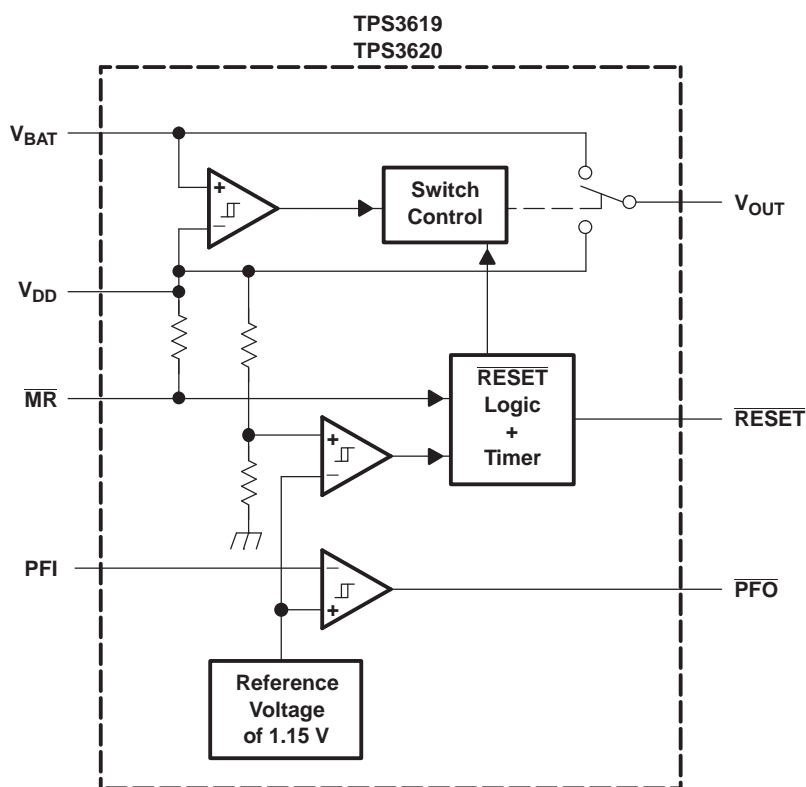

## TYPICAL CHARACTERISTICS

**STATIC DRAIN-SOURCE ON-STATE RESISTANCE  
 ( $V_{DD}$  to  $V_{OUT}$ )  
 vs  
 OUTPUT CURRENT**

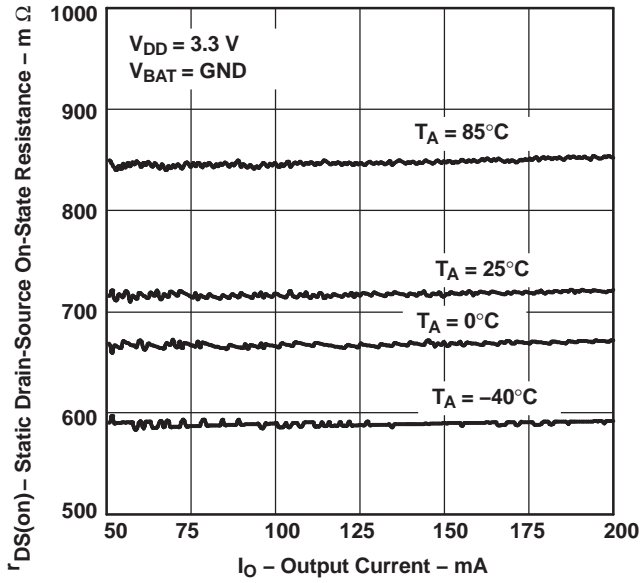

Figure 1.

**STATIC DRAIN-SOURCE ON-STATE RESISTANCE  
 ( $V_{BAT}$  to  $V_{OUT}$ )  
 vs  
 OUTPUT CURRENT**

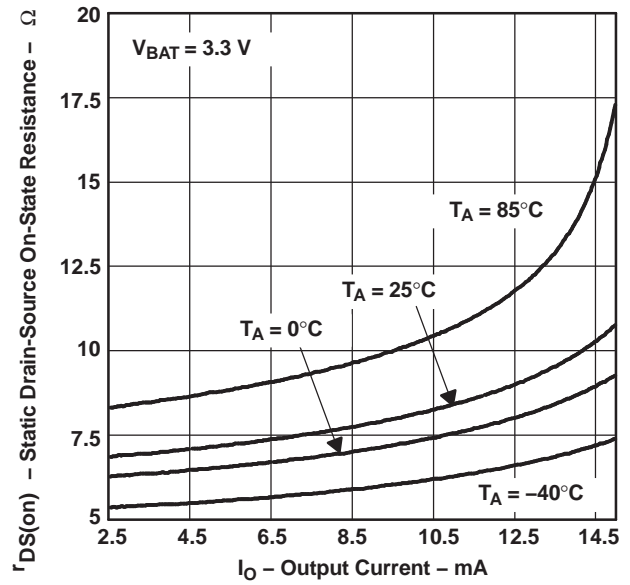

Figure 2.

**SUPPLY CURRENT  
 vs  
 SUPPLY VOLTAGE**

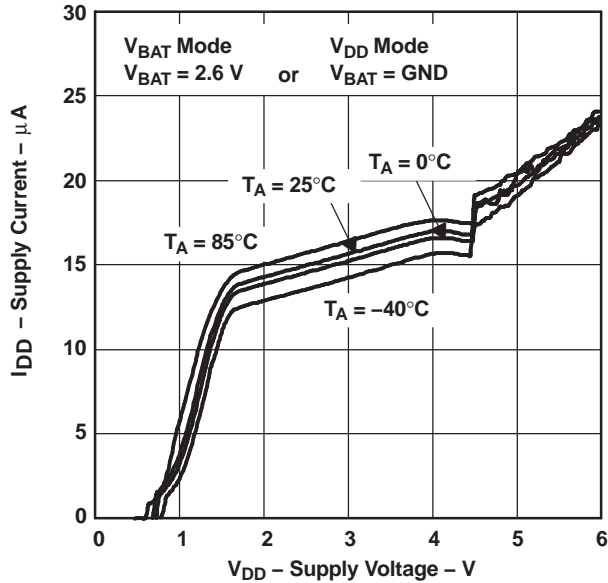

Figure 3.

**NORMALIZED THRESHOLD AT RESET  
 vs  
 FREE-AIR TEMPERATURE**

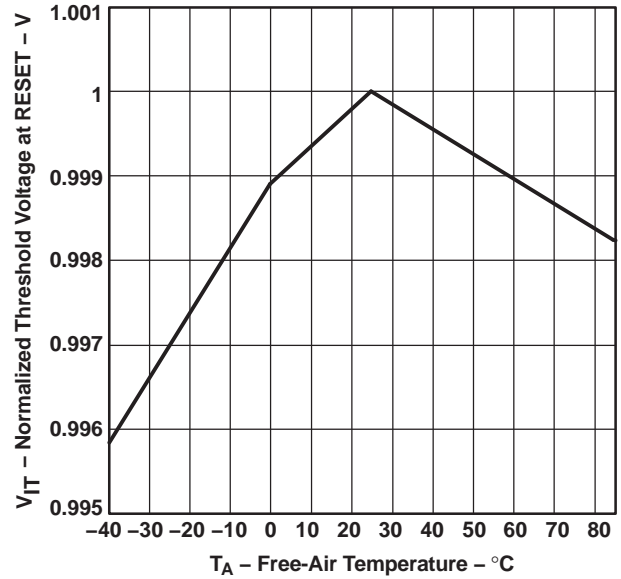

Figure 4.

TYPICAL CHARACTERISTICS (continued)

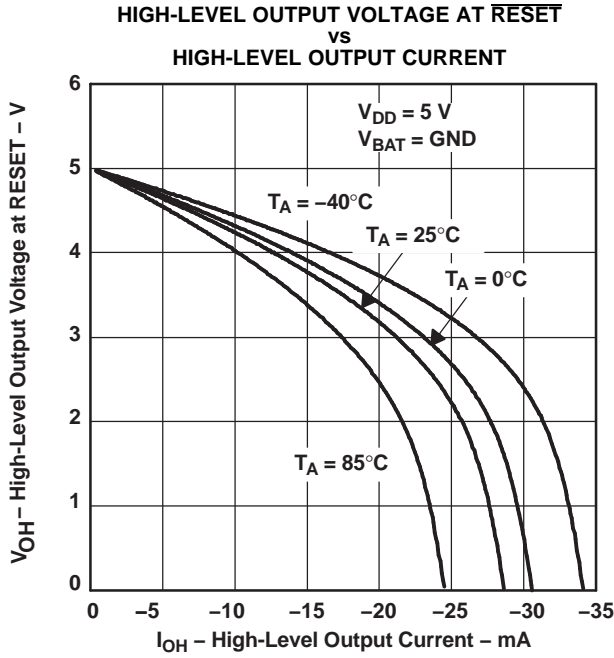

Figure 5.

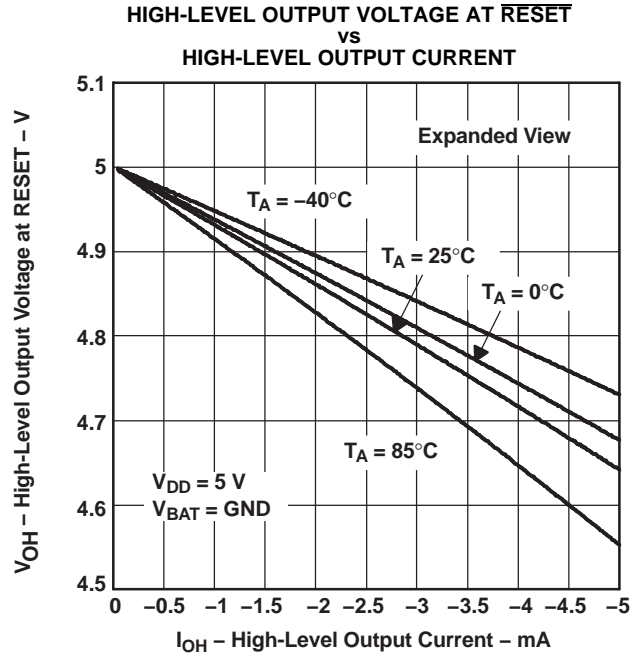

Figure 6.

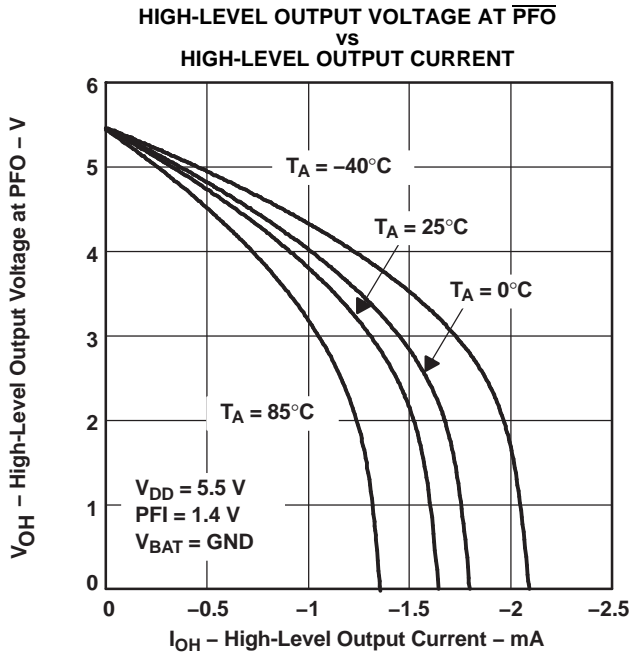

Figure 7.

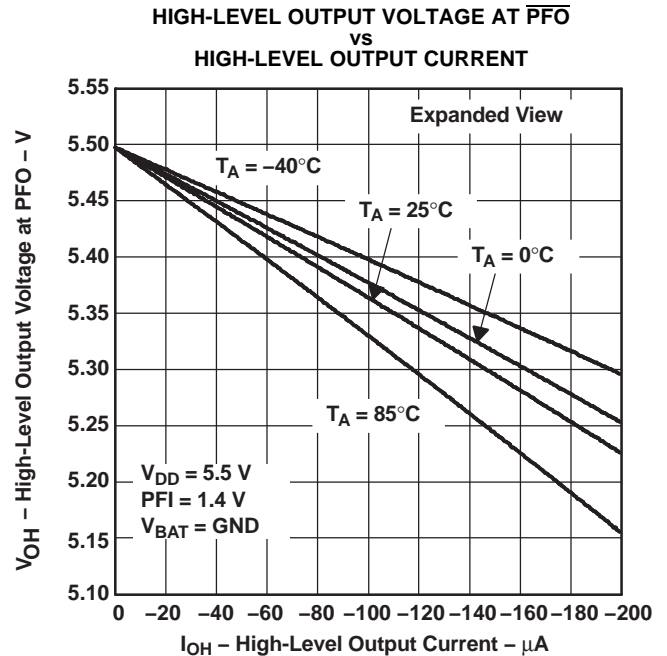

Figure 8.



**TYPICAL CHARACTERISTICS (continued)**

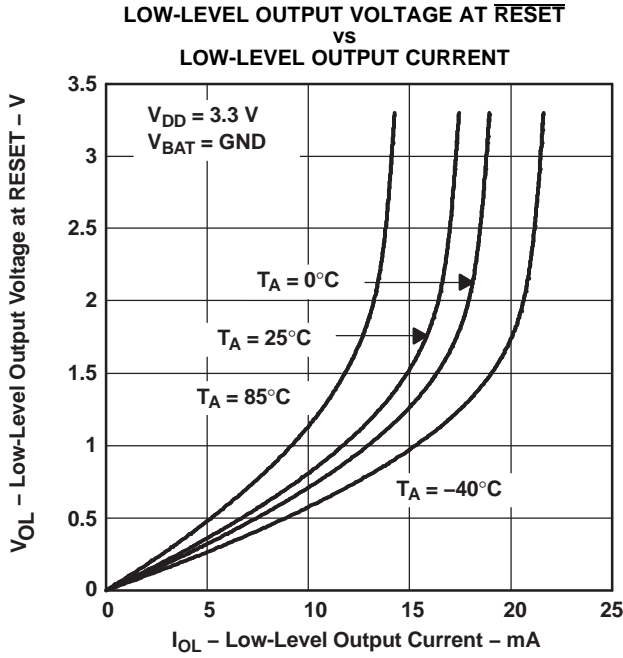

Figure 9.

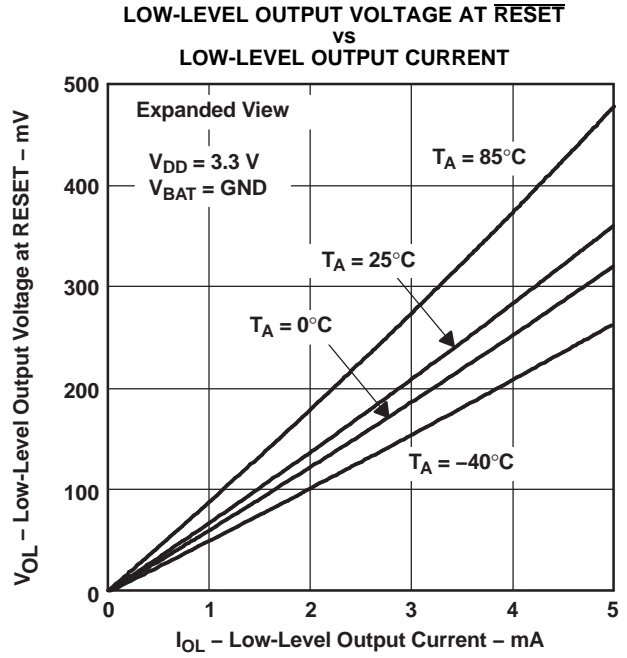

Figure 10.

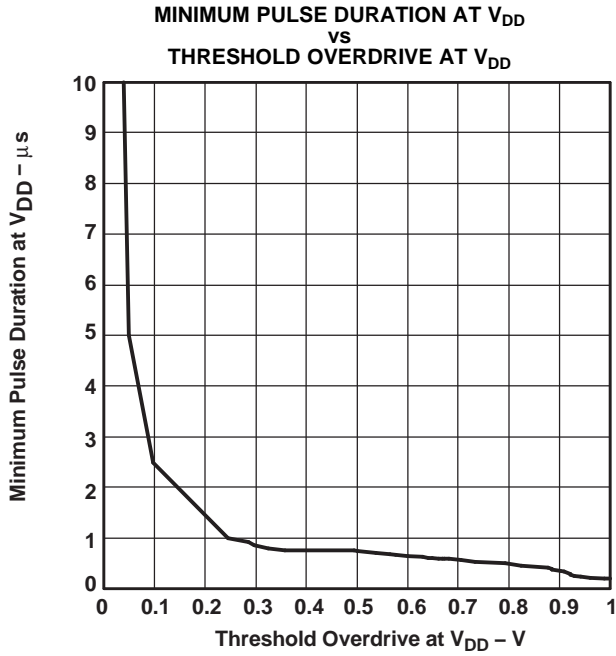

Figure 11.

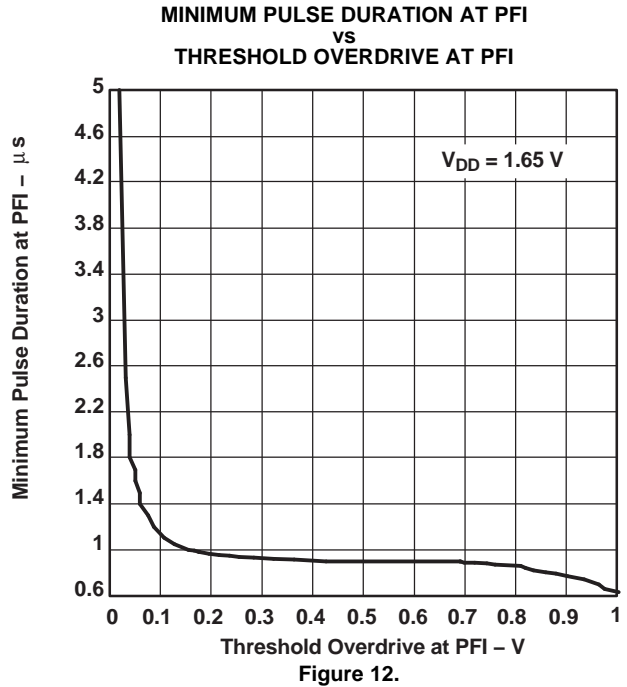

Figure 12.

## DETAILED DESCRIPTION

### Battery Freshness Seal (TPS3619)

The battery freshness seal of the TPS3619 family disconnects the backup-battery from internal circuitry until it is needed. This function prevents the backup-battery from being discharged until the final product is put to use. The following steps explain how to enable the freshness seal mode.

1. Connect  $V_{BAT}$  ( $V_{BAT} > V_{BAT\ min}$ )
2. Ground  $\overline{PFO}$
3. Connect PFI to  $V_{DD}$  ( $PFI = V_{DD}$ )
4. Connect  $V_{DD}$  to power supply ( $V_{DD} > V_{IT}$ ) and keep connected for  $5\ ms < t < 35\ ms$

The battery freshness seal mode is automatically removed by the positive-going edge of  $\overline{RESET}$  when  $V_{DD}$  is applied.

### Power-Fail Comparator (PFI and $\overline{PFO}$ )

An additional comparator is provided to monitor voltages other than the nominal supply voltage. The power-fail-input (PFI) is compared with an internal voltage reference of 1.15 V. If the input voltage falls below the power-fail threshold  $V_{IT(PFI)}$  of typical 1.15 V, the power-fail output ( $\overline{PFO}$ ) goes low. If  $V_{IT(PFI)}$  goes above  $V_{(PFI)}$ , plus about 12-mV hysteresis, the output returns to high. By connecting two external resistors, it is possible to supervise any voltages above  $V_{(PFI)}$ . The sum of both resistors should be about 1 M $\Omega$ , to minimize power consumption and also to assure that the current in the PFI pin can be ignored compared with the current through the resistor network. The tolerance of the external resistors should be not more than 1% to ensure minimal variation of sensed voltage. If the power-fail comparator is unused, PFI should be connected to ground and  $\overline{PFO}$  left unconnected.

### Backup-Battery Switchover

In case of a brownout or power failure, it may be necessary to preserve the contents of RAM. If a backup battery is installed at  $V_{BAT}$ , the device automatically switches the connected RAM to backup power when  $V_{DD}$  fails. In order to allow the backup battery (e.g., a 3.6-V lithium cell) to have a higher voltage than  $V_{DD}$ , these supervisors do not connect  $V_{BAT}$  to  $V_{OUT}$  when  $V_{BAT}$  is greater than  $V_{DD}$ .  $V_{BAT}$  only connects to  $V_{OUT}$  (through a 15- $\Omega$  switch) when  $V_{DD}$  falls below  $V_{IT}$  and  $V_{BAT}$  is greater than  $V_{DD}$ . When  $V_{DD}$  recovers, switchover is deferred either until  $V_{DD}$  crosses  $V_{BAT}$ , or until  $V_{DD}$  rises above the reset threshold  $V_{IT}$ .  $V_{OUT}$  connects to  $V_{DD}$  through a 1- $\Omega$  (max) PMOS switch when  $V_{DD}$  crosses the reset threshold.

| FUNCTION TABLE     |                   |           |
|--------------------|-------------------|-----------|
| $V_{DD} > V_{BAT}$ | $V_{DD} > V_{IT}$ | $V_{OUT}$ |
| 1                  | 1                 | $V_{DD}$  |
| 1                  | 0                 | $V_{DD}$  |
| 0                  | 1                 | $V_{DD}$  |
| 0                  | 0                 | $V_{BAT}$ |

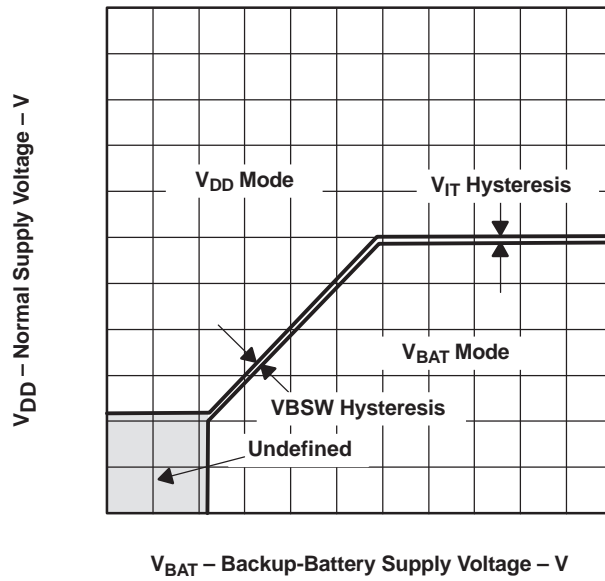

**Figure 13. Normal Supply Voltage vs Backup-Battery Supply Voltage**

**PACKAGING INFORMATION**

| Orderable Device | Status<br>(1) | Package Type | Package Drawing | Pins | Package Qty | Eco Plan<br>(2)         | Lead/Ball Finish<br>(6) | MSL Peak Temp<br>(3) | Op Temp (°C) | Device Marking<br>(4/5) | Samples                 |
|------------------|---------------|--------------|-----------------|------|-------------|-------------------------|-------------------------|----------------------|--------------|-------------------------|-------------------------|
| TPS3619-33DGK    | ACTIVE        | VSSOP        | DGK             | 8    | 80          | Green (RoHS & no Sb/Br) | CU NIPDAU               | Level-1-260C-UNLIM   | -40 to 85    | AFL                     | <a href="#">Samples</a> |
| TPS3619-33DGKG4  | ACTIVE        | VSSOP        | DGK             | 8    | 80          | Green (RoHS & no Sb/Br) | CU NIPDAU               | Level-1-260C-UNLIM   | -40 to 85    | AFL                     | <a href="#">Samples</a> |
| TPS3619-33DGKR   | ACTIVE        | VSSOP        | DGK             | 8    | 2500        | Green (RoHS & no Sb/Br) | CU NIPDAU               | Level-1-260C-UNLIM   | -40 to 85    | AFL                     | <a href="#">Samples</a> |
| TPS3619-33DGKRG4 | ACTIVE        | VSSOP        | DGK             | 8    | 2500        | Green (RoHS & no Sb/Br) | CU NIPDAU               | Level-1-260C-UNLIM   | -40 to 85    | AFL                     | <a href="#">Samples</a> |
| TPS3619-50DGK    | ACTIVE        | VSSOP        | DGK             | 8    | 80          | Green (RoHS & no Sb/Br) | CU NIPDAU               | Level-1-260C-UNLIM   | -40 to 85    | AFM                     | <a href="#">Samples</a> |
| TPS3619-50DGKR   | ACTIVE        | VSSOP        | DGK             | 8    | 2500        | Green (RoHS & no Sb/Br) | CU NIPDAU               | Level-1-260C-UNLIM   | -40 to 85    | AFM                     | <a href="#">Samples</a> |
| TPS3619-50DGKRG4 | ACTIVE        | VSSOP        | DGK             | 8    | 2500        | Green (RoHS & no Sb/Br) | CU NIPDAU               | Level-1-260C-UNLIM   | -40 to 85    | AFM                     | <a href="#">Samples</a> |
| TPS3620-33DGKR   | ACTIVE        | VSSOP        | DGK             | 8    | 2500        | Green (RoHS & no Sb/Br) | CU NIPDAU               | Level-1-260C-UNLIM   | -40 to 85    | ANL                     | <a href="#">Samples</a> |
| TPS3620-33DGKT   | ACTIVE        | VSSOP        | DGK             | 8    | 250         | Green (RoHS & no Sb/Br) | CU NIPDAU               | Level-1-260C-UNLIM   | -40 to 85    | ANL                     | <a href="#">Samples</a> |
| TPS3620-50DGKR   | ACTIVE        | VSSOP        | DGK             | 8    | 2500        | Green (RoHS & no Sb/Br) | CU NIPDAU               | Level-1-260C-UNLIM   | -40 to 85    | ANM                     | <a href="#">Samples</a> |
| TPS3620-50DGKT   | ACTIVE        | VSSOP        | DGK             | 8    | 250         | Green (RoHS & no Sb/Br) | CU NIPDAU               | Level-1-260C-UNLIM   | -40 to 85    | ANM                     | <a href="#">Samples</a> |

(1) The marketing status values are defined as follows:

**ACTIVE:** Product device recommended for new designs.

**LIFEBUY:** TI has announced that the device will be discontinued, and a lifetime-buy period is in effect.

**NRND:** Not recommended for new designs. Device is in production to support existing customers, but TI does not recommend using this part in a new design.

**PREVIEW:** Device has been announced but is not in production. Samples may or may not be available.

**OBSOLETE:** TI has discontinued the production of the device.

(2) **RoHS:** TI defines "RoHS" to mean semiconductor products that are compliant with the current EU RoHS requirements for all 10 RoHS substances, including the requirement that RoHS substance do not exceed 0.1% by weight in homogeneous materials. Where designed to be soldered at high temperatures, "RoHS" products are suitable for use in specified lead-free processes. TI may reference these types of products as "Pb-Free".

**RoHS Exempt:** TI defines "RoHS Exempt" to mean products that contain lead but are compliant with EU RoHS pursuant to a specific EU RoHS exemption.

**Green:** TI defines "Green" to mean the content of Chlorine (Cl) and Bromine (Br) based flame retardants meet JS709B low halogen requirements of <=1000ppm threshold. Antimony trioxide based flame retardants must also meet the <=1000ppm threshold requirement.

- (3) MSL, Peak Temp. - The Moisture Sensitivity Level rating according to the JEDEC industry standard classifications, and peak solder temperature.
- (4) There may be additional marking, which relates to the logo, the lot trace code information, or the environmental category on the device.
- (5) Multiple Device Markings will be inside parentheses. Only one Device Marking contained in parentheses and separated by a "~" will appear on a device. If a line is indented then it is a continuation of the previous line and the two combined represent the entire Device Marking for that device.
- (6) Lead/Ball Finish - Orderable Devices may have multiple material finish options. Finish options are separated by a vertical ruled line. Lead/Ball Finish values may wrap to two lines if the finish value exceeds the maximum column width.

**Important Information and Disclaimer:**The information provided on this page represents TI's knowledge and belief as of the date that it is provided. TI bases its knowledge and belief on information provided by third parties, and makes no representation or warranty as to the accuracy of such information. Efforts are underway to better integrate information from third parties. TI has taken and continues to take reasonable steps to provide representative and accurate information but may not have conducted destructive testing or chemical analysis on incoming materials and chemicals. TI and TI suppliers consider certain information to be proprietary, and thus CAS numbers and other limited information may not be available for release.

In no event shall TI's liability arising out of such information exceed the total purchase price of the TI part(s) at issue in this document sold by TI to Customer on an annual basis.

**TAPE AND REEL INFORMATION**

**QUADRANT ASSIGNMENTS FOR PIN 1 ORIENTATION IN TAPE**

\*All dimensions are nominal

| Device         | Package Type | Package Drawing | Pins | SPQ  | Reel Diameter (mm) | Reel Width W1 (mm) | A0 (mm) | B0 (mm) | K0 (mm) | P1 (mm) | W (mm) | Pin1 Quadrant |
|----------------|--------------|-----------------|------|------|--------------------|--------------------|---------|---------|---------|---------|--------|---------------|
| TPS3619-33DGKR | VSSOP        | DGK             | 8    | 2500 | 330.0              | 12.4               | 5.3     | 3.4     | 1.4     | 8.0     | 12.0   | Q1            |
| TPS3619-50DGKR | VSSOP        | DGK             | 8    | 2500 | 330.0              | 12.4               | 5.3     | 3.4     | 1.4     | 8.0     | 12.0   | Q1            |
| TPS3620-33DGKR | VSSOP        | DGK             | 8    | 2500 | 330.0              | 12.4               | 5.3     | 3.4     | 1.4     | 8.0     | 12.0   | Q1            |
| TPS3620-33DGKT | VSSOP        | DGK             | 8    | 250  | 330.0              | 12.4               | 5.3     | 3.4     | 1.4     | 8.0     | 12.0   | Q1            |
| TPS3620-50DGKR | VSSOP        | DGK             | 8    | 2500 | 330.0              | 12.4               | 5.3     | 3.4     | 1.4     | 8.0     | 12.0   | Q1            |
| TPS3620-50DGKT | VSSOP        | DGK             | 8    | 250  | 330.0              | 12.4               | 5.3     | 3.4     | 1.4     | 8.0     | 12.0   | Q1            |

**TAPE AND REEL BOX DIMENSIONS**

\*All dimensions are nominal

| Device         | Package Type | Package Drawing | Pins | SPQ  | Length (mm) | Width (mm) | Height (mm) |
|----------------|--------------|-----------------|------|------|-------------|------------|-------------|
| TPS3619-33DGKR | VSSOP        | DGK             | 8    | 2500 | 358.0       | 335.0      | 35.0        |
| TPS3619-50DGKR | VSSOP        | DGK             | 8    | 2500 | 358.0       | 335.0      | 35.0        |
| TPS3620-33DGKR | VSSOP        | DGK             | 8    | 2500 | 358.0       | 335.0      | 35.0        |
| TPS3620-33DGKT | VSSOP        | DGK             | 8    | 250  | 358.0       | 335.0      | 35.0        |
| TPS3620-50DGKR | VSSOP        | DGK             | 8    | 2500 | 358.0       | 335.0      | 35.0        |
| TPS3620-50DGKT | VSSOP        | DGK             | 8    | 250  | 358.0       | 335.0      | 35.0        |

DGK (S-PDSO-G8)

PLASTIC SMALL-OUTLINE PACKAGE



- NOTES:
- A. All linear dimensions are in millimeters.
  - B. This drawing is subject to change without notice.
  - C. Body length does not include mold flash, protrusions, or gate burrs. Mold flash, protrusions, or gate burrs shall not exceed 0.15 per end.
  - D. Body width does not include interlead flash. Interlead flash shall not exceed 0.50 per side.
  - E. Falls within JEDEC MO-187 variation AA, except interlead flash.



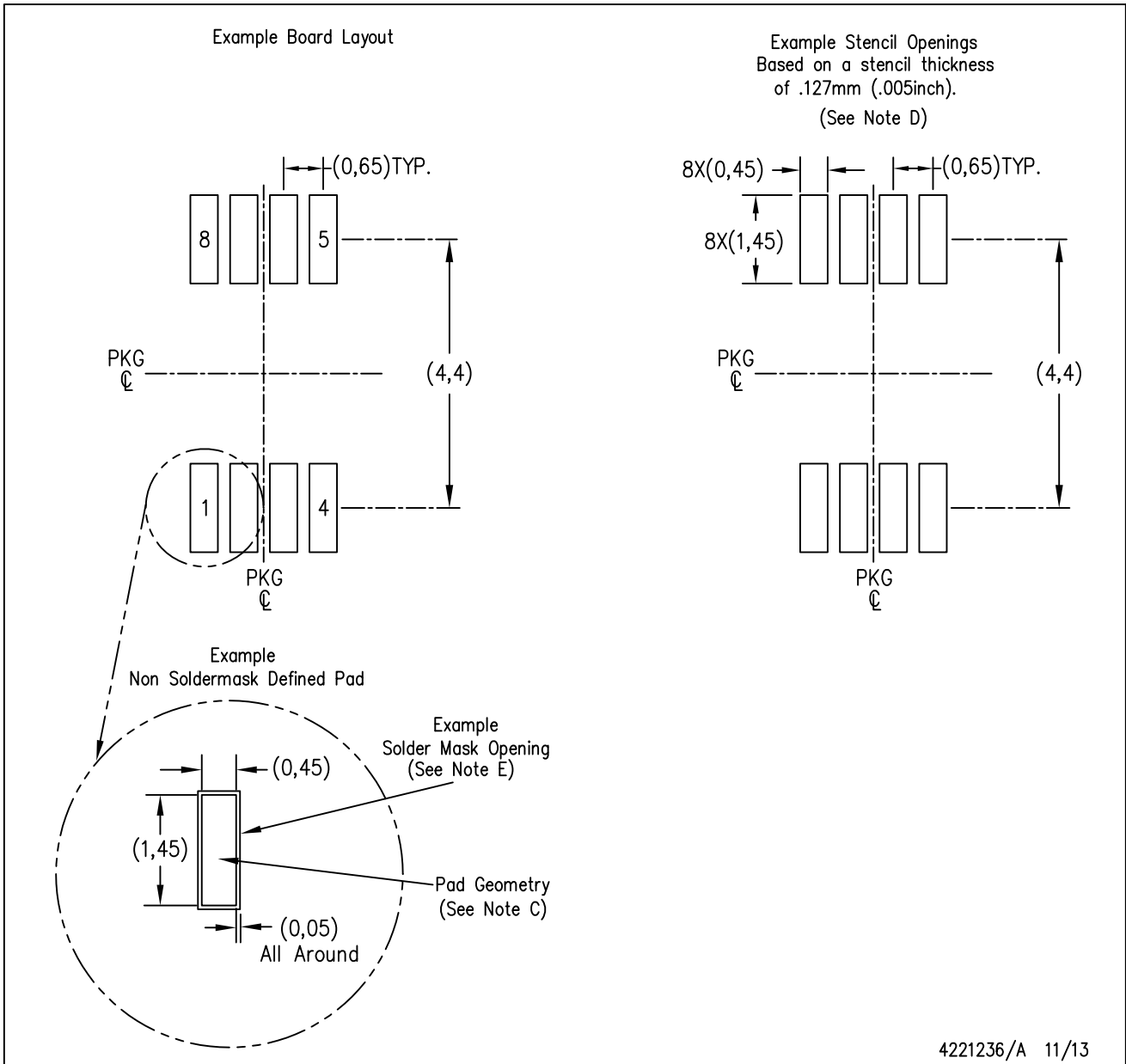

- NOTES:
- A. All linear dimensions are in millimeters.
  - B. This drawing is subject to change without notice.
  - C. Publication IPC-7351 is recommended for alternate designs.
  - D. Laser cutting apertures with trapezoidal walls and also rounding corners will offer better paste release. Customers should contact their board assembly site for stencil design recommendations. Refer to IPC-7525 for other stencil recommendations.
  - E. Customers should contact their board fabrication site for solder mask tolerances between and around signal pads.

## IMPORTANT NOTICE AND DISCLAIMER

TI PROVIDES TECHNICAL AND RELIABILITY DATA (INCLUDING DATASHEETS), DESIGN RESOURCES (INCLUDING REFERENCE DESIGNS), APPLICATION OR OTHER DESIGN ADVICE, WEB TOOLS, SAFETY INFORMATION, AND OTHER RESOURCES "AS IS" AND WITH ALL FAULTS, AND DISCLAIMS ALL WARRANTIES, EXPRESS AND IMPLIED, INCLUDING WITHOUT LIMITATION ANY IMPLIED WARRANTIES OF MERCHANTABILITY, FITNESS FOR A PARTICULAR PURPOSE OR NON-INFRINGEMENT OF THIRD PARTY INTELLECTUAL PROPERTY RIGHTS.

These resources are intended for skilled developers designing with TI products. You are solely responsible for (1) selecting the appropriate TI products for your application, (2) designing, validating and testing your application, and (3) ensuring your application meets applicable standards, and any other safety, security, or other requirements. These resources are subject to change without notice. TI grants you permission to use these resources only for development of an application that uses the TI products described in the resource. Other reproduction and display of these resources is prohibited. No license is granted to any other TI intellectual property right or to any third party intellectual property right. TI disclaims responsibility for, and you will fully indemnify TI and its representatives against, any claims, damages, costs, losses, and liabilities arising out of your use of these resources.

TI's products are provided subject to TI's Terms of Sale ([www.ti.com/legal/termsofsale.html](http://www.ti.com/legal/termsofsale.html)) or other applicable terms available either on [ti.com](http://ti.com) or provided in conjunction with such TI products. TI's provision of these resources does not expand or otherwise alter TI's applicable warranties or warranty disclaimers for TI products.

Mailing Address: Texas Instruments, Post Office Box 655303, Dallas, Texas 75265  
Copyright © 2019, Texas Instruments Incorporated