

# TPS24720 2.5-V to 18-V High-Efficiency Adjustable Power-Limiting Hot-Swap Controller With Current Monitor and Overvoltage Protection

## 1 Features

- 2.5-V to 18-V Operation
- Accurate Current Limiting for Startup
- Programmable FET SOA Protection
- Adjustable Current Sense Threshold
- Programmable Fault Timer
- Power-Good Output
- Fast Breaker for Short-Circuit Protection
- Analog Load-Current Monitor Output
- Programmable UV and OV
- Low-current Standby Mode
- FET Fault Detection Flag
- 3-mm × 3-mm, 16-Pin QFN package

## 2 Applications

- Server Backplanes
- Storage Area Networks (SAN)
- Telecommunications Mezzanine Cards
- Medical Systems
- Plug-In Modules
- Base Stations

## 3 Description

The TPS24720 is an easy-to-use, full-featured protection device for 2.5-V to 18-V power rails. This hot-swap controller drives an external N-channel MOSFET, while protecting source, load and external MOSFET against multiple potentially damaging events. During startup, load current and MOSFET power dissipation are limited to user-selected values. After startup, currents above the user-selected limit will be allowed to flow until programmed timeout – except in extreme overload events when load is immediately disconnected from source.

Programmable power limiting ensures the external MOSFET operates inside its safe operating area (SOA) at all times. This allows use of smaller FETs while improving system reliability. Power good, Fault, FET Fault, and current monitor outputs are provided for system status monitoring and downstream load control.

### Device Information<sup>(1)</sup>

PART NUMBER	PACKAGE	BODY SIZE (NOM)
TPS24720	VQFN (16)	3.00 mm × 3.00 mm

(1) For all available packages, see the orderable addendum at the end of the data sheet.

### Typical Application (12 V at 10 A)

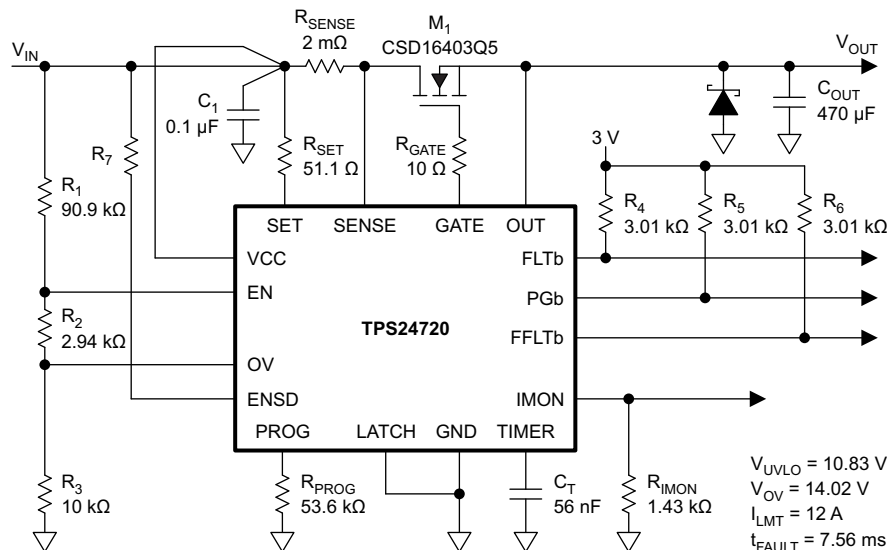

Copyright © 2016, Texas Instruments Incorporated



## Table of Contents

<b>1 Features</b> .....	1	7.3 Feature Description.....	13
<b>2 Applications</b> .....	1	7.4 Device Functional Modes.....	17
<b>3 Description</b> .....	1	<b>8 Application and Implementation</b> .....	24
<b>4 Revision History</b> .....	2	8.1 Application Information.....	24
<b>5 Pin Configuration and Functions</b> .....	4	8.2 Typical Application .....	24
<b>6 Specifications</b> .....	5	<b>9 Power Supply Recommendations</b> .....	30
6.1 Absolute Maximum Ratings .....	5	<b>10 Layout</b> .....	31
6.2 ESD Ratings .....	5	10.1 Layout Guidelines .....	31
6.3 THERMAL INFORMATION.....	5	10.2 Layout Example .....	31
6.4 Recommended Operating Conditions.....	5	<b>11 Device and Documentation Support</b> .....	32
6.5 Electrical Characteristics.....	6	11.1 Documentation Support .....	32
6.6 Timing Requirements.....	8	11.2 Trademarks .....	32
6.7 Typical Characteristics.....	9	11.3 Electrostatic Discharge Caution.....	32
<b>7 Detailed Description</b> .....	13	11.4 Glossary .....	32
7.1 Overview .....	13	<b>12 Mechanical, Packaging, and Orderable Information</b> .....	32
7.2 Functional Block Diagram .....	13		

## 4 Revision History

NOTE: Page numbers for previous revisions may differ from page numbers in the current version.

### Changes from Revision D (March 2015) to Revision E Page

- Changed the Part Number From TPS247120 To: TPS24720 in the *Device Information* table..... 1

### Changes from Revision C (September 2013) to Revision D Page

- Added *ESD Rating* table, *Feature Description* section, *Device Functional Modes*, *Application and Implementation* section, *Power Supply Recommendations* section, *Layout* section, *Device and Documentation Support* section, and *Mechanical, Packaging, and Orderable Information* section. .... 1
- Changed the Input voltage range, PROG - MAX value in the *Absolute Maximum Ratings* table From: 0.3 To: 3.6 ..... 5
- Deleted External capacitance - GATE from the *Recommended Operating Conditions*..... 5
- Deleted text from the last paragraph in the *GATE* section "If used, any capacitor connecting GATE and GND should not exceed 1  $\mu$ F and it should be connected in series with a resistor of no less than 1 k $\Omega$ ."..... 15
- Deleted section: *Alternative Design Example: GATE Capacitor (dV/dt) Control in Inrush Mode*..... 29
- Deleted text from the *High-Gate-Capacitance Applications* section "When gate capacitor dV/dt control is used, ... then a Zener diode is not necessary."..... 29

### Changes from Revision B (May 2011) to Revision C Page

- Added Note to Supply Current Disabled .....
- Added Note to Fast-turnoff delay.....
- Changed Gate Comparator 6 V to 5.9 V in *Functional Block Diagram*.....
- Changed text From : (6 V for  $V_{VCC} = 12$  V) To: (5.9 V for  $V_{VCC} = 12$  V) in the GATE pin description .....
- Changed [Equation 1](#) .....
- Changed text in the INRUSH OPERATION section.....
- Changed [Equation 8](#).....
- Added text and new [Equation 9](#) .....
- Changed [Equation 11](#) .....
- Changed text From:  $V_{GS}$  rises 6 V To:  $V_{GS}$  rises 5.9 V .....
- Changed text following [Equation 11](#), From: 1.23 ms To 1.22 ms .....

• Changed <i>Equation 15</i> .....	29
• Changed text describing <i>Equation 15</i> and <i>Equation 16</i> in the <i>Alternative Design Example</i> section. ( <i>Equation 15</i> and <i>Equation 16</i> deleted by revision F.).....	29

---

<b>Changes from Revision A (April 2011) to Revision B</b>	<b>Page</b>
---	-------------

---

• Changed voltages in PGb pin description from 140 mV and 340 mV to 170 mV and 240 mV.....	15
• Changed $R_{IMON}$ equation .....	26

---

<b>Changes from Original (March 2011) to Revision A</b>	<b>Page</b>
---	-------------

---

• Corrected voltages shown <i>Functional Block Diagram</i> .....	13
--	----

---

## 5 Pin Configuration and Functions

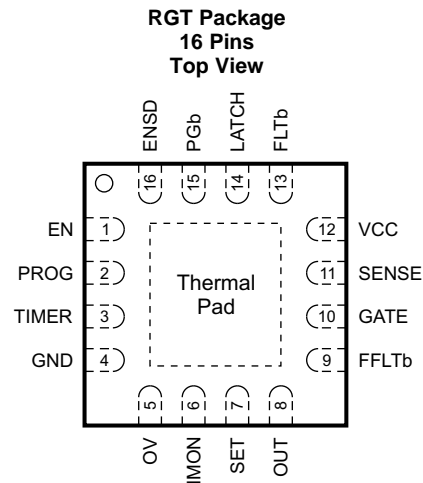

### Pin Functions

PIN		I/O	DESCRIPTION
NAME	NO.		
EN	1	I	Active-high enable input. Logic input. Connects to resistor divider.
ENSD	16	I	Pull low to put device into low-current standby mode. Logic input.
FFLTb	9	O	Active-low, open-drain FET fault indicator. Indicates shorted MOSFET when output is off.
FLTb	13	O	Active-low, open-drain output indicates overload fault timer has turned MOSFET off.
GATE	10	O	Gate driver output for external MOSFET
GND	4	–	Ground
IMON	6	O	Analog load current limit program point. Connect R <sub>IMON</sub> to ground.
LATCH	14	I	Latch or retry mode select input. Latch when floating or connected to a logic-level voltage; retry when connected to GND.
OUT	8	I	Output voltage sensor for monitoring MOSFET power.
OV	5	I	Overvoltage comparator input. Connects to resistor divider. GATE is pulled low when OV exceeds the threshold.
PGb	15	O	Active-low, open-drain power-good indicator. Status is determined by the voltage across the MOSFET.
PROG	2	I	Power-limiting programming pin. A resistor from this pin to GND sets the maximum power dissipation for the FET.
SENSE	11	I	Current-sensing input for resistor shunt from VCC to SENSE.
SET	7	I	Current-limit programming set pin. A resistor is connected from this pin to VCC.
TIMER	3	I/O	A capacitor connected from this pin to GND provides a fault timing function.
VCC	12	I	Input-voltage sense and power supply
Thermal pad	—	—	Tied to GND

## 6 Specifications

### 6.1 Absolute Maximum Ratings

over operating free-air temperature range, all voltages referred to GND (unless otherwise noted)

		MIN	MAX	UNIT
Input voltage range	EN, FFLTb <sup>(1)</sup> , FLTb <sup>(1)</sup> , GATE, OUT, PGb <sup>(1)</sup> , SENSE, SET <sup>(1)</sup> , VCC	-0.3	30	V
	ENSD, OV	-0.3	20	
	PROG <sup>(1)</sup>	-0.3	3.6	
	[SET, SENSE] to VCC	-0.3	0.3	
	IMON, LATCH, TIMER	-0.3	5	
Sink current	FFLTb, FLTb, PGb		5	mA
Source current	PROG	Internally limited		
	IMON		5	mA
Temperature	Maximum junction, T <sub>J</sub>	Internally limited		°C

(1) Do not apply voltage directly to these pins.

### 6.2 ESD Ratings

			VALUE	UNIT	
V <sub>(ESD)</sub>	Electrostatic discharge	Human-body model (HBM), per ANSI/ESDA/JEDEC JS-001 <sup>(1)</sup>	All pins except PGb	±2000	V
			PIN PGb	±500	V
		Charged-device model (CDM), per JEDEC specification JESD22-C101 <sup>(2)</sup>		±500	V

(1) JEDEC document JEP155 states that 500-V HBM allows safe manufacturing with a standard ESD control process.

(2) JEDEC document JEP157 states that 250-V CDM allows safe manufacturing with a standard ESD control process.

### 6.3 THERMAL INFORMATION

THERMAL METRIC <sup>(1)</sup>		TPS24720	UNIT
		QFN (16) PINS	
R <sub>θJA</sub>	Junction-to-ambient thermal resistance	47.3	°C/W
R <sub>θJctop</sub>	Junction-to-case (top) thermal resistance	63.8	°C/W
R <sub>θJB</sub>	Junction-to-board thermal resistance	20.9	°C/W
Ψ <sub>JT</sub>	Junction-to-top characterization parameter	1.6	°C/W
Ψ <sub>JB</sub>	Junction-to-board characterization parameter	21	°C/W
R <sub>θJcbot</sub>	Junction-to-case (bottom) thermal resistance	5.1	°C/W

(1) For more information about traditional and new thermal metrics, see the *Semiconductor and IC Package Thermal Metrics* application report ([SPRA953](#)).

### 6.4 Recommended Operating Conditions

over operating free-air temperature range (unless otherwise noted)

		MIN	NOM	MAX	UNIT
Input voltage range	ENSD, OV	0		16	V
	SENSE, SET <sup>(1)</sup> , VCC	2.5		18	
	EN, FFLTb, FLTb, PGb, OUT	0		18	
Sink current	FFLTb, FLTb, PGb	0		2	mA
Source current	IMON	0		1	mA
Resistance	PROG	4.99		500	kΩ
External capacitance	TIMER	1			nF
Operating junction temperature range, T <sub>J</sub>		-40		125	°C

(1) Do not apply voltage directly to these pins.

## 6.5 Electrical Characteristics

–40°C ≤ T<sub>J</sub> ≤ 125°C, V<sub>CC</sub> = 12 V, V<sub>EN</sub> = 3 V, V<sub>ENSD</sub> = 3 V, R<sub>SET</sub> = 190 Ω, R<sub>IMON</sub> = 5 kΩ, and R<sub>PROG</sub> = 50 kΩ to GND.

All voltages referenced to GND, unless otherwise noted.

PARAMETER	CONDITIONS	MIN	NOM	MAX	UNIT
<b>VCC</b>					
UVLO threshold, rising		2.2	2.32	2.45	V
UVLO threshold, falling		2.1	2.22	2.35	V
UVLO hysteresis <sup>(1)</sup>			0.1		V
Supply current	Enabled — I <sub>OUT</sub> + I <sub>VCC</sub> + I <sub>SENSE</sub>		1	1.4	mA
	Disabled <sup>(1)</sup> — EN = 0 V, I <sub>OUT</sub> + I <sub>VCC</sub> + I <sub>SENSE</sub>		0.45		mA
	Shutdown — ENSD = 0 V, I <sub>OUT</sub> + I <sub>VCC</sub> + I <sub>SENSE</sub>		1.7	10	μA
<b>EN</b>					
Threshold voltage, falling		1.2	1.3	1.4	V
Hysteresis <sup>(1)</sup>			50		mV
Input leakage current	0 V ≤ V <sub>EN</sub> ≤ 30 V	–1	0	1	μA
<b>ENSD</b>					
Threshold voltage	Rising or falling edge	0.3	0.7	1.4	V
Pullup current	V <sub>ENSD</sub> = 5 V	0.5	1.2	2	μA
<b>OV</b>					
Threshold voltage, rising		1.25	1.35	1.45	V
Hysteresis <sup>(1)</sup>			60		mV
Input leakage current	0 V ≤ V <sub>OV</sub> ≤ 30 V	–1	0	1	μA
Deglintch time	OV rising	0.5	1.2	1.5	μs
<b>FLTb</b>					
Output low voltage	Sinking 2 mA		0.11	0.25	V
Input leakage current	V <sub>FLTb</sub> = 0 V, 30 V	–1	0	1	μA
<b>PGb</b>					
Threshold	V <sub>(SENSE – OUT)</sub> rising, PGb going high	140	240	340	mV
Hysteresis <sup>(1)</sup>	Measured V <sub>(SENSE – OUT)</sub> falling, PGb going low		70		mV
Output low voltage	Sinking 2 mA		0.11	0.25	V
Input leakage current	V <sub>PGb</sub> = 0 V, 30 V	–1	0	1	μA
<b>FFLTb</b>					
V <sub>IMON</sub> threshold	Measured V <sub>IMON</sub> to GND	90	103	115	mV
Output low voltage	Sinking 2 mA		0.11	0.25	V
Input leakage current	FFLTb = 0 V, 30 V	–1	0	1	μA
<b>PROG</b>					
Bias voltage	Sourcing 10 μA	0.65	0.678	0.7	V
Input leakage current	V <sub>PROG</sub> = 1.5 V	–0.2	0	0.2	μA
<b>TIMER</b>					
Sourcing current	V <sub>TIMER</sub> = 0 V	8	10	12	μA
Sinking current	V <sub>TIMER</sub> = 2 V	8	10	12	μA
	V <sub>EN</sub> = 0 V, V <sub>TIMER</sub> = 2 V	2	4.5	7	mA
Upper threshold voltage		1.3	1.35	1.4	V
Lower threshold voltage		0.33	0.35	0.37	V
Timer activation voltage	Raise GATE until I <sub>TIMER</sub> sinking, measure V <sub>(GATE – VCC)</sub> , V <sub>VCC</sub> = 12 V	5	5.9	7	V
Bleed-down resistance	V <sub>ENSD</sub> = 0 V, V <sub>TIMER</sub> = 2 V	70	104	130	kΩ
<b>IMON</b>					
Summing threshold	Current limit in regulation	660	675	690	mV

(1) Parameters are provided for reference only, and do not constitute part of TI's published specifications for purposes of TI product warranty.

**Electrical Characteristics (continued)**
 $-40^{\circ}\text{C} \leq T_J \leq 125^{\circ}\text{C}$ ,  $V_{CC} = 12\text{ V}$ ,  $V_{EN} = 3\text{ V}$ ,  $V_{ENSD} = 3\text{ V}$ ,  $R_{SET} = 190\ \Omega$ ,  $R_{IMON} = 5\text{ k}\Omega$ , and  $R_{PROG} = 50\text{ k}\Omega$  to GND.

All voltages referenced to GND, unless otherwise noted.

PARAMETER	CONDITIONS	MIN	NOM	MAX	UNIT
<b>OUT</b>					
Input bias current	$V_{OUT} = 12\text{ V}$		16	30	$\mu\text{A}$
<b>SET</b>					
Input referred offset	Measure SET to SENSE	-1.5	0	1.5	mV
<b>GATE</b>					
Output voltage	$V_{OUT} = 12\text{ V}$	23.5	25.8	28	V
Clamp voltage	Inject $10\ \mu\text{A}$ into GATE, measure $V_{(GATE - V_{CC})}$	12	13.9	15.5	V
Sourcing current	$V_{GATE} = 12\text{ V}$	20	30	40	$\mu\text{A}$
Sinking current	Fast turnoff, $V_{GATE} = 14\text{ V}$	0.5	1	1.4	A
	Sustained, $V_{GATE} = 4\text{ V to }23\text{ V}$	6	11	20	mA
	In inrush current limit, $V_{GATE} = 4\text{ V to }23\text{ V}$	20	30	40	$\mu\text{A}$
Pulldown resistance	Thermal shutdown or $V_{ENSD} = 0\text{ V}$	14	20	26	k $\Omega$
<b>SENSE</b>					
Input bias current	$V_{SENSE} = 12\text{ V}$ , sinking current		30	40	$\mu\text{A}$
Current limit threshold	$V_{OUT} = 12\text{ V}$	22.5	25	27.5	mV
Power limit threshold	$V_{OUT} = 7\text{ V}$ , $R_{PROG} = 50\text{ k}\Omega$	10	12.5	15	mV
	$V_{OUT} = 2\text{ V}$ , $R_{PROG} = 25\text{ k}\Omega$	10	12.5	15	
Fast-trip threshold		52	60	68	mV
<b>LATCH</b>					
Threshold, rising		0.3	0.9	1.4	V
Pullup current	$V_{LATCH} = 0\text{ V}$	7	10	13	$\mu\text{A}$
<b>OTSD</b>					
Threshold, rising		130	140		$^{\circ}\text{C}$
Hysteresis <sup>(1)</sup>			10		$^{\circ}\text{C}$

### 6.6 Timing Requirements

		MIN	NOM	MAX	UNIT
<b>EN</b>					
Turnoff time	EN ↓ to $V_{GATE} < 1\text{ V}$ , $C_{GATE} = 33\text{ nF}$	20	60	150	μs
Deglintch time	EN ↑	8	14	18	μs
Disable delay	EN ↓ to GATE ↓, $C_{GATE} = 0$ , $t_{pff50-90}$ , See <a href="#">Figure 1</a>	0.1	0.4	1	μs
<b>ENSD</b>					
Disable delay	ENSD to GATE, $t_{pff50-90}$ , See <a href="#">Figure 1</a>		0.75	1	μs
<b>FFLTb</b>					
Delay	FFLTb falling	60	115	140	ms
<b>PG, PGb</b>					
Delay (deglintch) time	Rising or falling edge	2	3.4	6	ms
<b>GATE</b>					
Turn on delay	$V_{VCC}$ rising to GATE sourcing, $t_{prf50-50}$ , See <a href="#">Figure 3</a>		100	250	μs
<b>SENSE</b>					
Fast-turnoff duration		8	13.5	18	μs
Fast-turnoff delay (1)	$V_{(VCC - SENSE)} = 80\text{ mV}$ , $C_{GATE} = 0\text{ pF}$ , $t_{prf50-50}$ , See <a href="#">Figure 4</a>		200		ns

(1) Parameters are provided for reference only, and do not constitute part of TI's published specifications for purposes of TI product warranty.

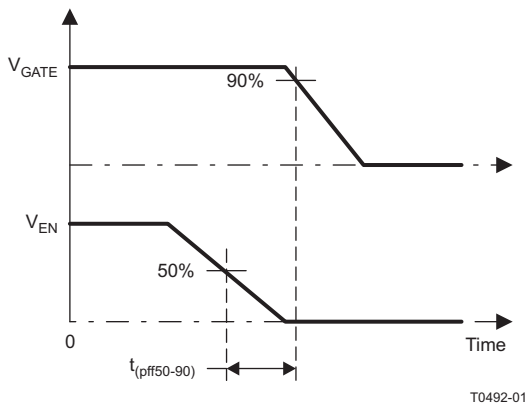

Figure 1.  $t_{pff50-90}$  Timing Definition

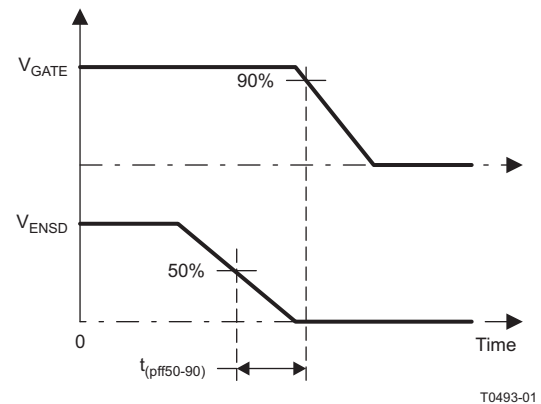

Figure 2.  $t_{pff50-90}$  Timing Definition

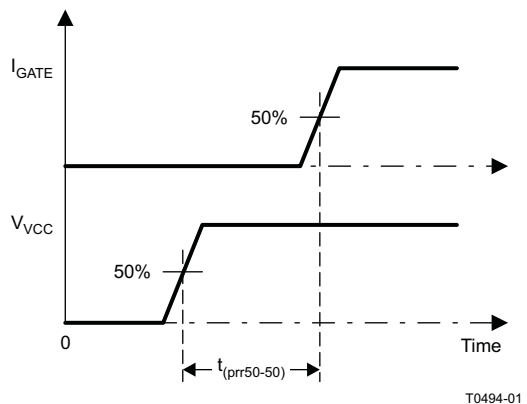

Figure 3.  $t_{prf50-50}$  Timing Definition

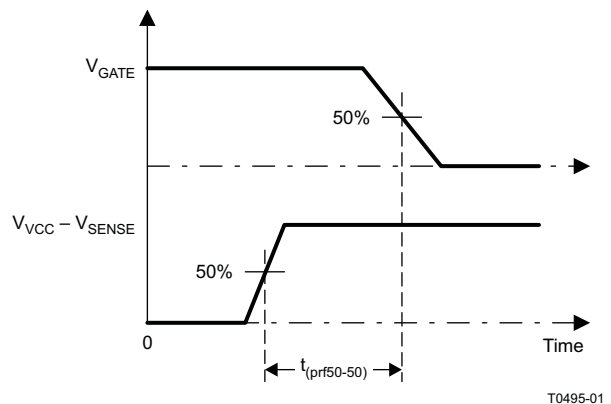

Figure 4.  $t_{prf50-50}$  Timing Definition



### 6.7 Typical Characteristics

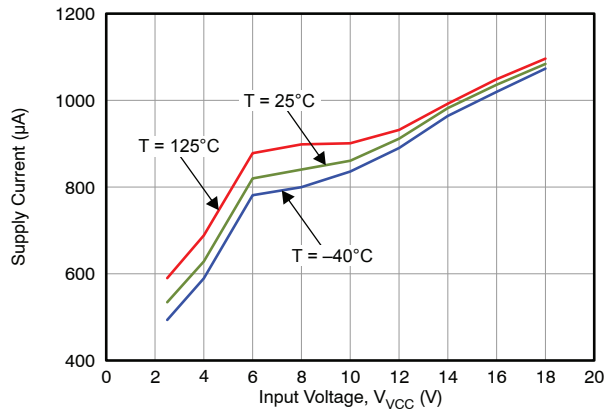

Figure 5. Supply Current vs Input Voltage at Normal Operation (EN = High)

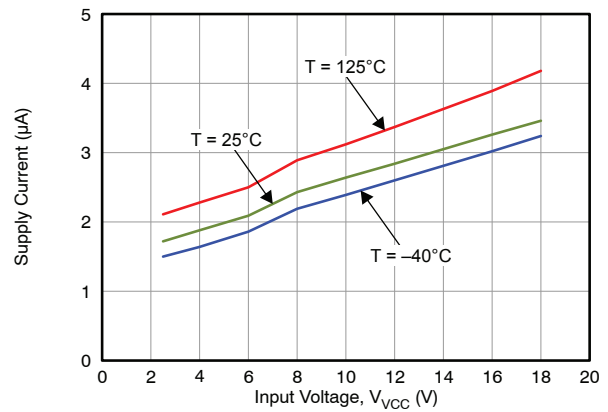

Figure 6. Supply Current vs Input Voltage at Shutdown (EN = 0 V)

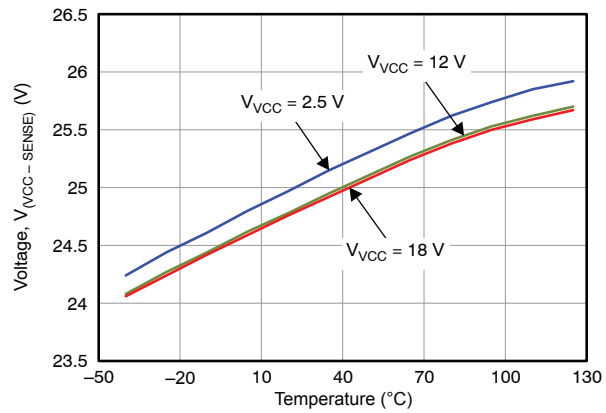

Figure 7. Voltage Across  $R_{SENSE}$  in Inrush Current Limiting vs Temperature

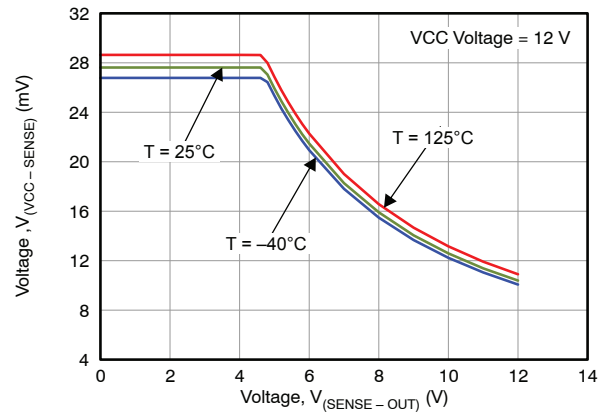

Figure 8. Voltage Across  $R_{SENSE}$  in Inrush Power Limiting vs  $V_{DS}$  of Pass MOSFET

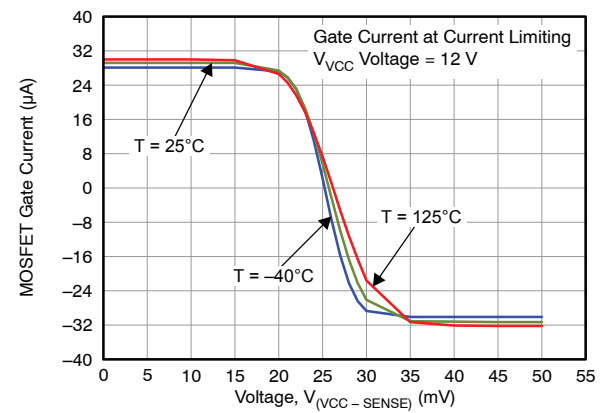

Figure 9. MOSFET Gate Current vs Voltage Across  $R_{SENSE}$  During Inrush Power Limiting

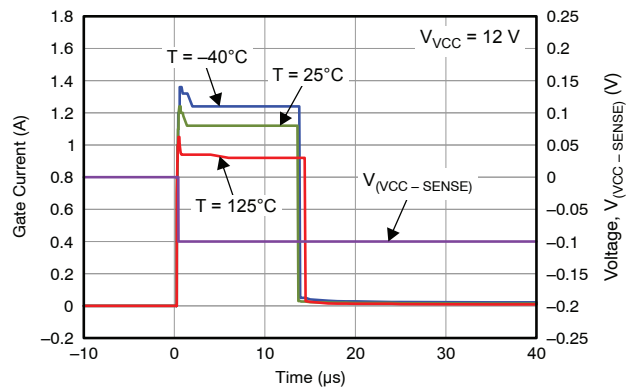
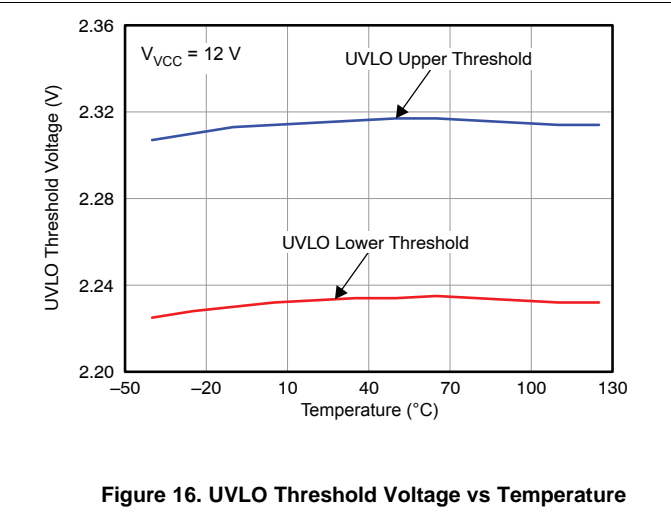
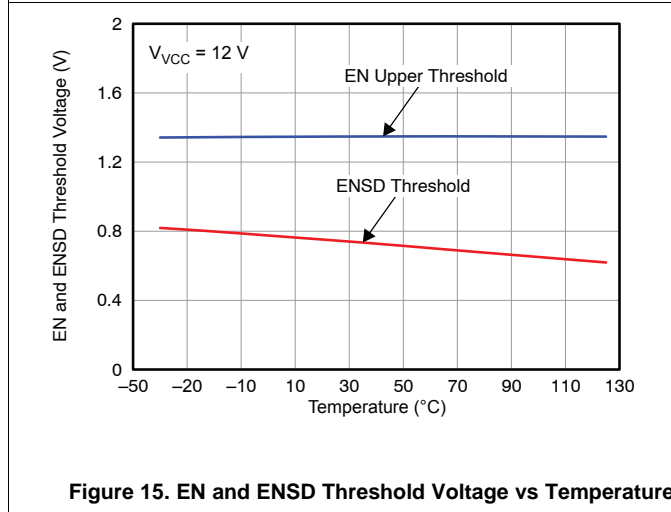
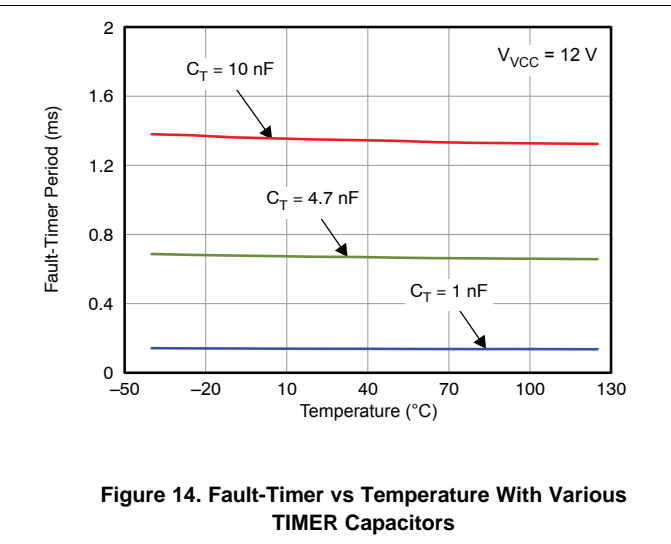
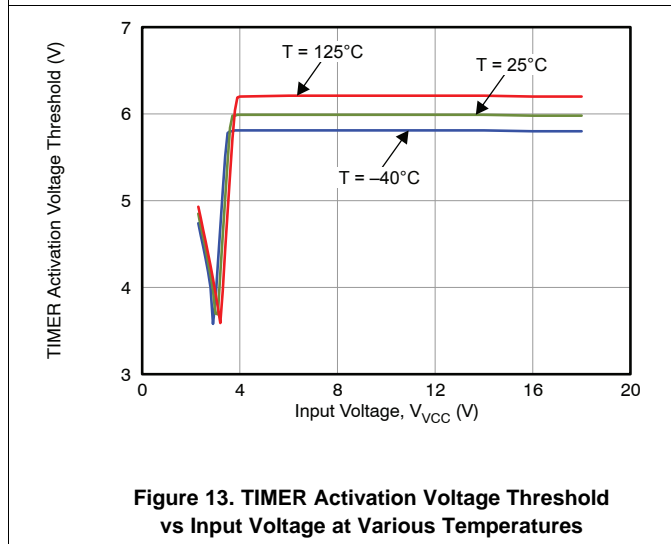
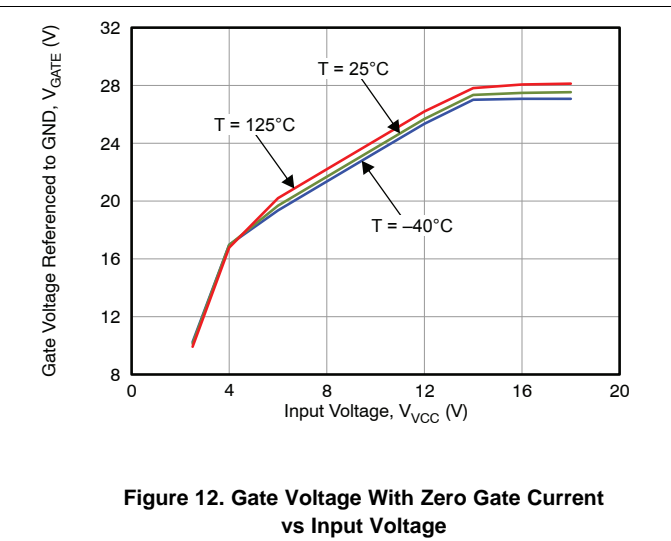
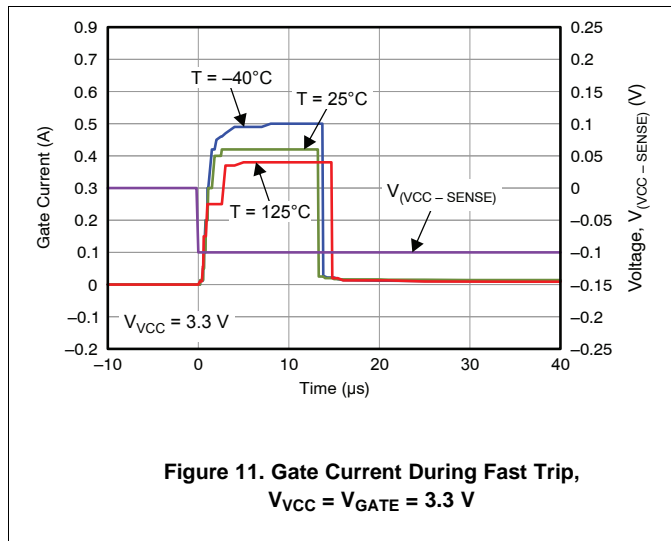
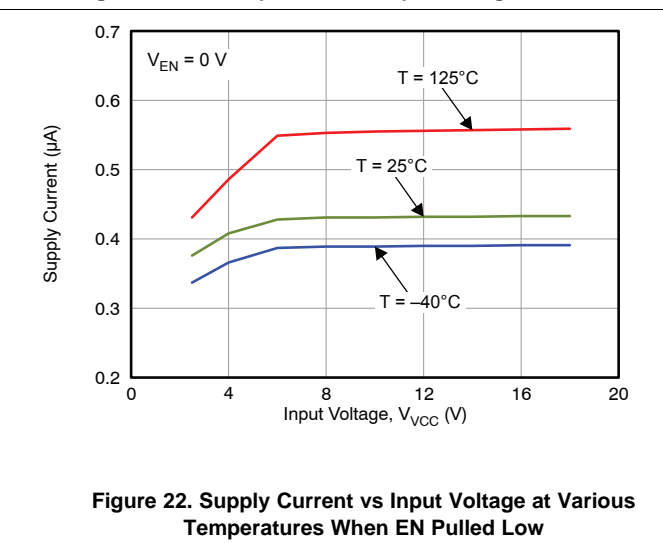
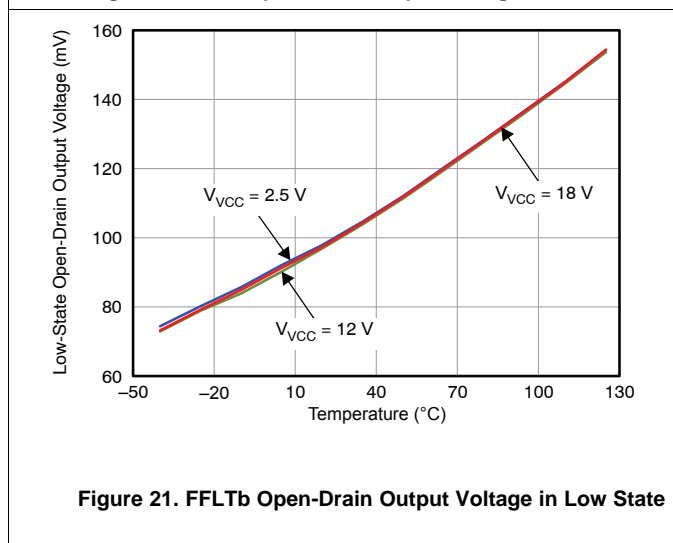
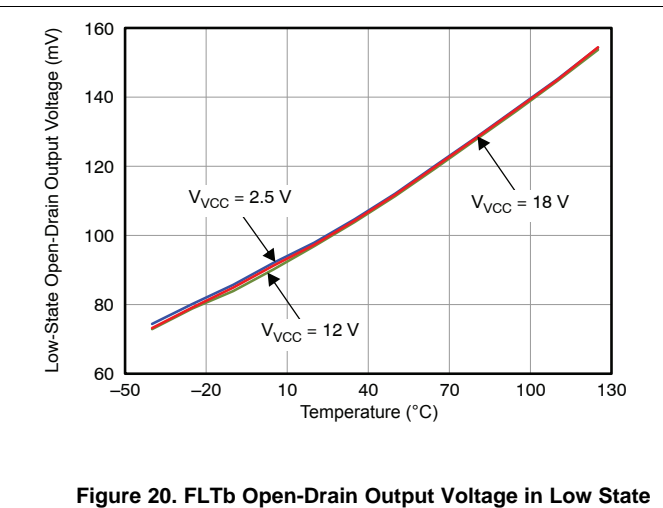
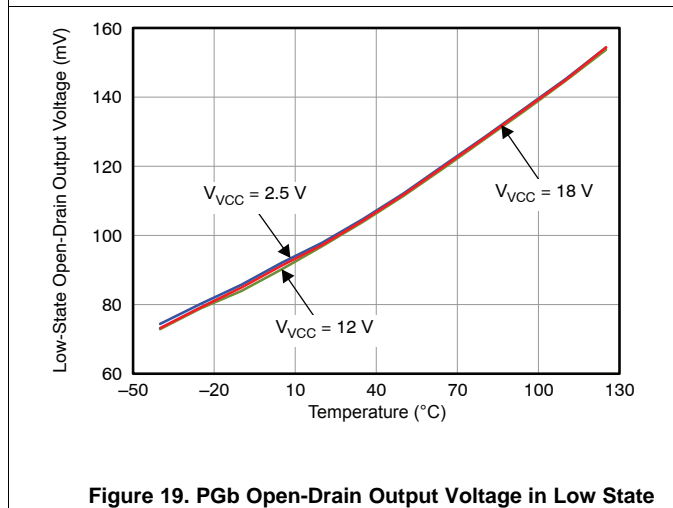
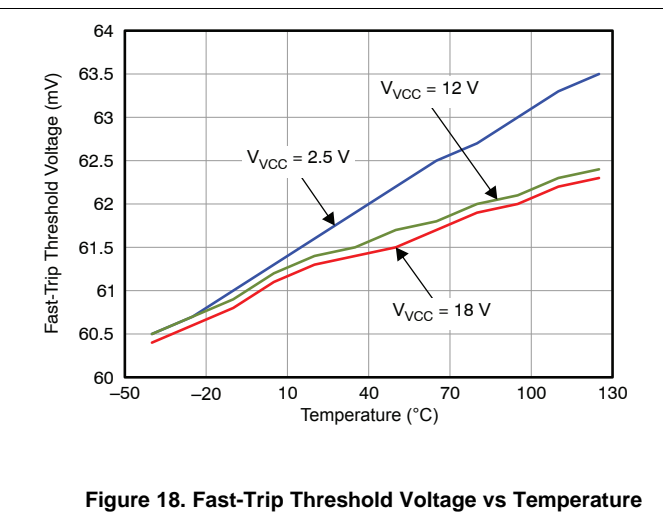
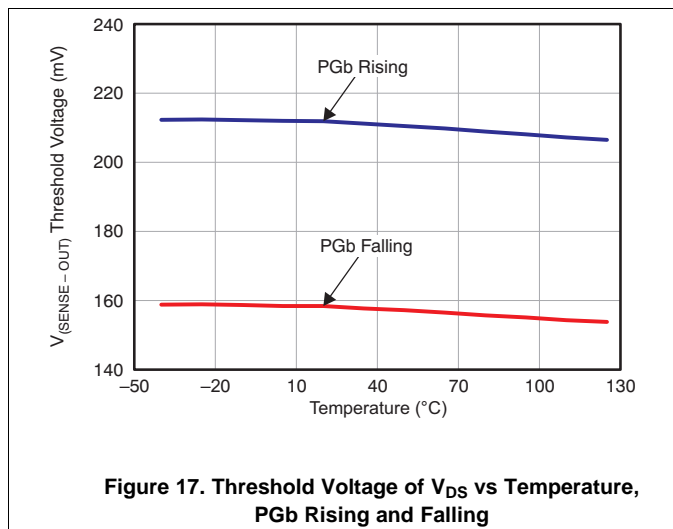

Figure 10. Gate Current During Fast Trip,  $V_{VCC} = V_{GATE} = 12 V$

Typical Characteristics (continued)



Typical Characteristics (continued)



Typical Characteristics (continued)

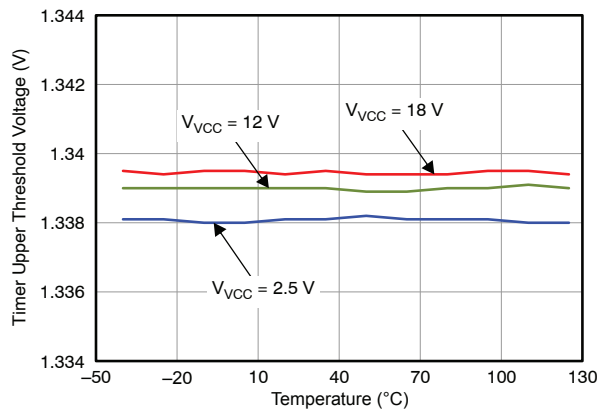

Figure 23. Timer Upper Threshold Voltage vs Temperature at Various Input Voltages

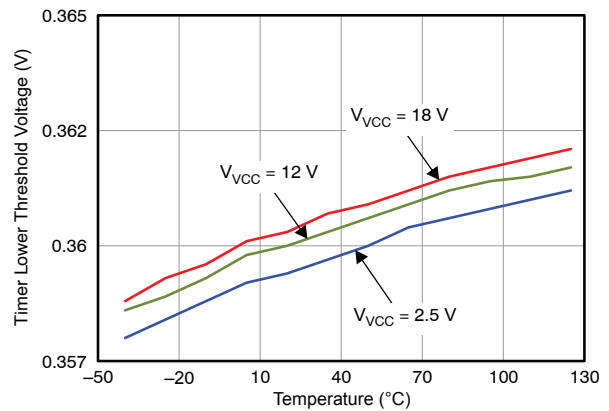

Figure 24. Timer Lower Threshold Voltage vs Temperature at Various Input Voltages

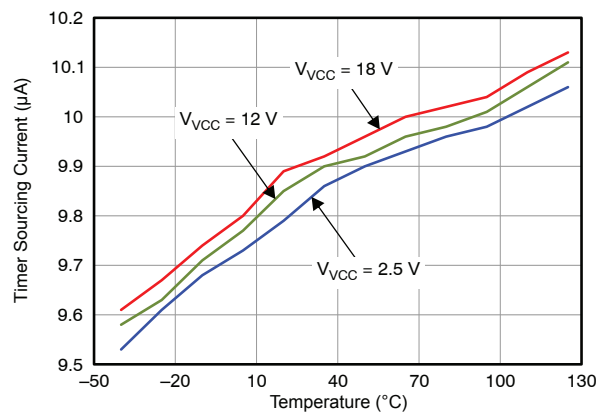

Figure 25. Timer Sourcing Current vs Temperature at Various Input Voltages

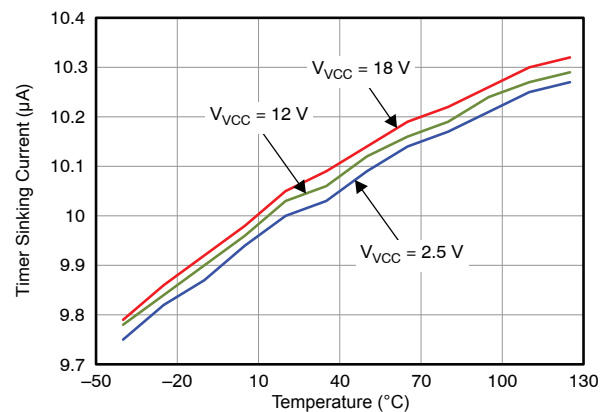

Figure 26. Timer Sinking Current vs Temperature at Various Input Voltages

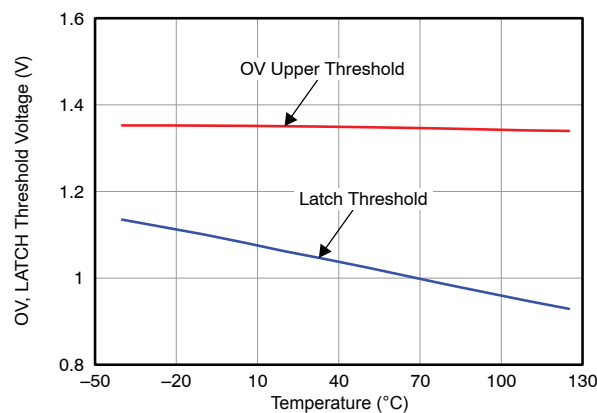
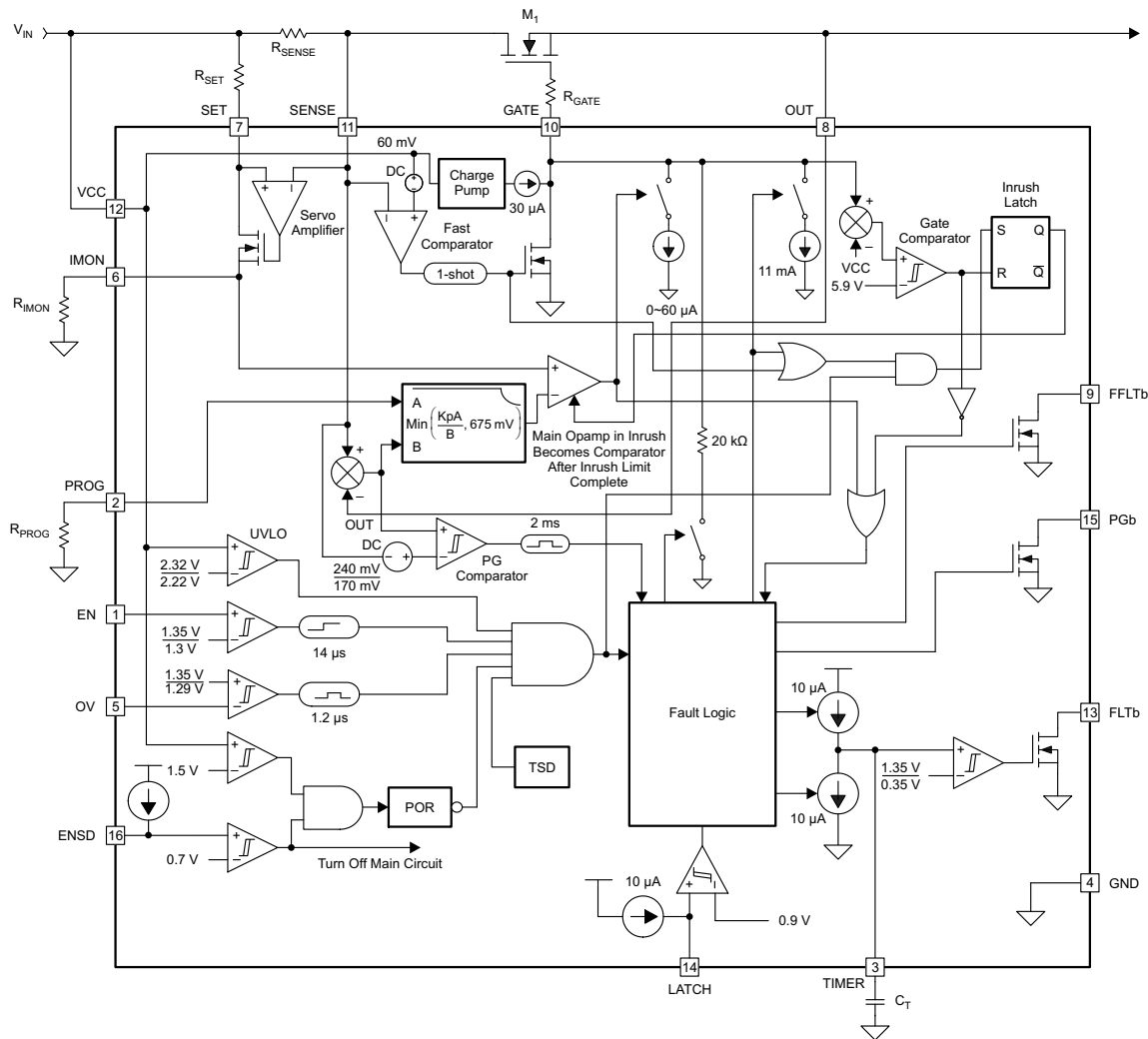

Figure 27. OV and LATCH Threshold Voltage vs Temperature

## 7 Detailed Description

### 7.1 Overview

### 7.2 Functional Block Diagram



Copyright © 2016, Texas Instruments Incorporated

Figure 28. Block Diagram of the TPS24720

### 7.3 Feature Description

#### 7.3.1 Detailed Pin Descriptions

The following description relies on the typical application diagram shown on the front page of this data sheet, as well as the functional block diagram in [Figure 28](#).

##### 7.3.1.1 EN

Applying a voltage of 1.35 V or more to this pin enables the gate driver. The addition of an external resistor divider allows the EN pin to serve as an undervoltage monitor. Cycling EN low and then back high resets the TPS24720 that has latched off due to a fault condition. This pin should not be left floating.

## Feature Description (continued)

### 7.3.1.2 ENSD

When this pin is pulled low, it shuts off all internal circuitry and thus places the device in a low-current standby mode. While in standby, the PGb, FLTb, and FFLTb outputs assume high-impedance states. A 20-k $\Omega$  resistor pulls GATE to GND in standby. This is a much weaker pulldown than the 11 mA drawn while the part is disabled (e.g., by EN, UVLO, OV, or overload fault current). Applications requiring rapid turnoff should disable the device using the EN pin before pulling ENSD low. This pin is preferably pulled up to a positive voltage from 2 V to 18 V, if not otherwise connected.

### 7.3.1.3 FFLTb

This active-low open-drain output pulls low if  $V_{VCC}$  is higher than the UVLO rising threshold and the voltage on the IMON pin exceeds 103 mV when EN is disabled. The presence of this voltage indicates that current continues to flow through the external circuitry even though the external MOSFET has been turned off. This presumably indicates a shorted MOSFET. FFLTb assumes a high impedance if one of the following conditions occurs:

- ENSD is pulled low.
- Temperature on the die exceeds the OTSD shutdown threshold.
- $V_{VCC}$  drops below the UVLO falling threshold.

FFLTb also asserts if  $V_{VCC}$  is higher than the UVLO rising threshold, GATE is disabled by OV, and the voltage on the IMON pin exceeds 103 mV. This pin can be left floating when not used.

### 7.3.1.4 FLTb

This active-low open-drain output pulls low when the TPS24720 has remained in current limit long enough for the fault timer to expire. The behavior of the FLTb pin depends on the status of the LATCH pin. If the LATCH pin is held high or left floating, the TPS24720 operates in latch mode. If the LATCH pin is held low, the TPS24720 operates in retry mode. In latch mode, a fault timeout disables the external MOSFET and holds FLTb low. The latched mode of operation is reset by cycling EN, VCC, or ENSD. In retry mode, a fault timeout first disables the external MOSFET, next waits sixteen cycles of TIMER charging and discharging, and finally attempts a restart. This process repeats as long as the fault persists. In retry mode, the FLTb pin is pulled low whenever the external MOSFET is disabled by the fault timer. In a sustained fault, the FLTb waveform becomes a train of pulses. The FLTb pin does not assert if the external MOSFET is disabled by EN, ENSD, OV, overtemperature shutdown, or UVLO. This pin can be left floating when not used.

### 7.3.1.5 GATE

This pin provides gate drive to the external MOSFET. A charge pump sources 30  $\mu$ A to enhance the external MOSFET. A 13.9-V clamp between GATE and VCC limits the gate-to-source voltage, because  $V_{VCC}$  is very close to  $V_{OUT}$  in normal operation. During start-up, a transconductance amplifier regulates the gate voltage of  $M_1$  to provide inrush current limiting. The TIMER pin charges timer capacitor  $C_T$  during the inrush. Inrush current limiting continues until the  $V_{(GATE - VCC)}$  exceeds the Timer Activation Voltage (5.9 V for  $V_{VCC} = 12$  V). Then the TPS24720 enters into circuit-breaker mode. The Timer Activation Voltage is defined as a threshold voltage. When  $V_{(GATE - VCC)}$  exceeds this threshold voltage, the inrush operation is finished and the TIMER stops sourcing current and begins sinking current. In the circuit-breaker mode, the current flowing in  $R_{SENSE}$  is compared with the current-limit threshold derived from the MOSFET power-limit scheme (see PROG). If the current flowing in  $R_{SENSE}$  exceeds the current limit threshold, then MOSFET  $M_1$  is turned off. The GATE pin is disabled by the following three mechanisms:

1. GATE is pulled down by an 11-mA current source when
  - The fault timer expires during an overload current fault ( $V_{IMON} > 675$  mV)
  - $V_{EN}$  is below its falling threshold
  - $V_{VCC}$  drops below the UVLO threshold
  - $V_{OV}$  is above its rising threshold
2. GATE is pulled down by a 1-A current source for 13.5  $\mu$ s when a hard output short circuit occurs and  $V_{(VCC - R_{SENSE})}$  is greater than 60 mV, i.e., the fast-trip shutdown threshold. After fast-trip shutdown is complete, an 11-mA sustaining current ensures that the external MOSFET remains off.
3. GATE is discharged by a 20-k $\Omega$  resistor to GND if the chip die temperature exceeds the OTSD rising

## Feature Description (continued)

threshold or ENSD is pulled low.

GATE remains low in latch mode and attempts a restart periodically in retry mode.

No external resistor should be directly connected from GATE to GND or from GATE to OUT.

### 7.3.1.6 GND

This pin is connected to system ground.

### 7.3.1.7 IMON

A resistor connected from this pin to GND scales the current-limit and power-limit settings, as illustrated in [Figure 28](#). The voltage present at this pin is proportional to the current flowing through sense resistor  $R_{SENSE}$ . This voltage can be used as a means of monitoring current flow through the system. The value of  $R_{IMON}$  can be calculated from [Equation 3](#). This pin should not have a bypass capacitor or any other load except for  $R_{IMON}$ .

### 7.3.1.8 LATCH

This pin determines whether the TPS24720 operates in latch mode or retry mode. Applying a voltage of 2 V to 5 V to this pin or allowing it to float selects latch mode. Tying the pin to ground selects retry mode. In latch mode, an overload current fault disables the TPS24720 until EN, ENSD, or VCC is cycled. In retry mode, the TPS24720 automatically attempts a restart after every sixteen cycles of TIMER charging and discharging. In a sustained fault in retry mode, the external MOSFET conducts 3.93% of the time; i.e., the duty ratio is 0.0393. If the LATCH pin is allowed to float, then its open-circuit voltage is approximately 2.28 V.

### 7.3.1.9 OUT

This pin allows the controller to measure the drain-to-source voltage across the external MOSFET  $M_1$ . The power-good indicator (PGb) relies on this information, as does the power-limiting engine. The OUT pin should be protected from negative voltage transients by a clamping diode or sufficient capacitors. A Schottky diode of 3 A / 40 V in a SMC package is recommended as a clamping diode for high-power applications. The OUT pin should be bypassed to GND with a low-impedance ceramic capacitor in the range of 10 nF to 1  $\mu$ F.

### 7.3.1.10 OV

This pin is used to program the device overvoltage level. A voltage of more than 1.35 V on this pin turns off the external MOSFET. A resistor divider connected from VCC to this pin provides overvoltage protection for the downstream load. This pin should be tied to GND when not used.

### 7.3.1.11 PGb

This active-low, open-drain output is intended to interface to downstream dc/dc converters or monitoring circuits. PGb pulls low after the drain-to-source voltage of the FET has fallen below 170 mV and a 3.4-ms deglitch delay has elapsed. It goes open-drain when  $V_{DS}$  exceeds 240 mV. PGb assumes high-impedance status after a 3.4-ms deglitch delay once  $V_{DS}$  of  $M_1$  rises up, resulting from GATE being pulled to GND at any of the following conditions:

- An overload current fault occurs ( $V_{IMON} > 675$  mV).
- A hard output short circuit occurs, leading to  $V_{(VCC - SENSE)}$  greater than 60 mV, i.e., the fast-trip shutdown threshold has been exceeded.
- $V_{EN}$  is below its falling threshold.
- $V_{ENSD}$  is below its threshold.
- $V_{VCC}$  drops below the UVLO threshold.
- $V_{OV}$  is above its rising threshold.
- Die temperature exceeds the OTSD threshold.

This pin can be left floating when not used.

## Feature Description (continued)

### 7.3.1.12 PROG

A resistor from this pin to GND sets the maximum power permitted in the external MOSFET  $M_1$  during inrush. Do not apply a voltage to this pin. If the constant power limit is not desired, use a PROG resistor of 4.99 k $\Omega$ . To set the maximum power, use [Equation 1](#),

$$P_{LIM} = \frac{84375}{R_{PROG} \times R_{SENSE}} \times \frac{R_{SET}}{R_{IMON}} \quad (1)$$

where  $P_{LIM}$  is the allowed power limit of MOSFET  $M_1$ .  $R_{SENSE}$  is the load-current-monitoring resistor connected between the VCC pin and the SENSE pin.  $R_{PROG}$  is the resistor connected from the PROG pin to GND. Both  $R_{PROG}$  and  $R_{SENSE}$  are in ohms and  $P_{LIM}$  is in watts.  $P_{LIM}$  is determined by the maximum allowed thermal stress of MOSFET  $M_1$ , given by [Equation 2](#),

$$P_{LIM} < \frac{T_{J(MAX)} - T_{C(MAX)}}{R_{\theta JC(MAX)}} \quad (2)$$

where  $T_{J(MAX)}$  is the maximum desired transient junction temperature and  $T_{C(MAX)}$  is the maximum case temperature prior to a start or restart.  $R_{\theta JC(MAX)}$  is the junction-to-case thermal impedance of the pass MOSFET  $M_1$  in units of  $^{\circ}\text{C}/\text{W}$ . Both  $T_{J(MAX)}$  and  $T_{C(MAX)}$  are in  $^{\circ}\text{C}$ .

### 7.3.1.13 SENSE

This pin connects to the negative terminal of  $R_{SENSE}$ . It provides a means of sensing the voltage across this resistor, as well as a way to monitor the drain-to-source voltage across the external FET. The current limit  $I_{LIM}$  is set by [Equation 3](#).

$$I_{LIM} = \frac{0.675 \text{ V} \times R_{SET}}{R_{IMON} \times R_{SENSE}} \quad (3)$$

A fast-trip shutdown occurs when  $V_{(VCC - V_{SENSE})}$  exceeds 60 mV.

### 7.3.1.14 SET

A resistor  $R_{SET}$  is connected from this pin to the positive terminal of  $R_{SENSE}$ . This resistor scales the current limit and power limit settings. It coordinates with  $R_{IMON}$  and  $R_{SENSE}$  to determine the current limit value. The value of  $R_{SET}$  can be calculated from [Equation 3](#) (see SENSE).

### 7.3.1.15 TIMER

A capacitor  $C_T$  connected from the TIMER pin to GND determines the overload fault timing. TIMER sources 10  $\mu\text{A}$  when an overload is present, and discharges  $C_T$  at 10  $\mu\text{A}$  otherwise.  $M_1$  is turned off when  $V_{TIMER}$  reaches 1.35 V. In an application implementing auto-retry after a fault, this capacitor also determines the period before the external MOSFET is re-enabled. A minimum timing capacitance of 1 nF is recommended to ensure proper operation of the fault timer. The value of  $C_T$  can be calculated from the desired fault time  $t_{FLT}$ , using [Equation 4](#).

$$C_T = \frac{10 \mu\text{A}}{1.35 \text{ V}} \times t_{FLT} \quad (4)$$

As is explained in the description of the LATCH pin, either latch mode or retry mode occurs if the load current exceeds the current limit threshold or the fast-trip shutdown threshold, depending on the status of the LATCH pin. While in latch mode, the TIMER pin continues to charge and discharge the attached capacitor periodically. In retry mode, the external MOSFET is disabled for sixteen cycles of TIMER charging and discharging. The TIMER pin is pulled to GND by a 2-mA current source at the end of the 16<sup>th</sup> cycle of charging and discharging. The external MOSFET is then re-enabled. The TIMER pin capacitor,  $C_T$ , can also be discharged to GND during latch mode or retry mode in the following two ways:

1. A 2-mA current sinks TIMER whenever any of the following occurs:
  - $V_{EN}$  is below its falling threshold.
  - $V_{VCC}$  drops below the UVLO threshold.
  - $V_{OV}$  is above its rising threshold.
2. A 100-k $\Omega$  resistor is connected to TIMER and discharges  $C_T$  at the moment when  $V_{ENSD}$  drops below its



## Feature Description (continued)

threshold.

TIMER is not affected when the die temperature exceeds the OTSD threshold.

### 7.3.1.16 VCC

This pin performs three functions. First, it provides biasing power to the integrated circuit. Second, it serves as an input to the power-on reset (POR) and undervoltage lockout (UVLO) functions. The VCC trace from the integrated circuit should connect directly to the positive terminal of  $R_{SENSE}$  to minimize the voltage sensing error. Bypass capacitor  $C_1$ , shown in the typical application diagram on the front page, should be connected to the positive terminal of  $R_{SENSE}$ . A capacitance of at least 10 nF is recommended.

## 7.4 Device Functional Modes

The TPS24720 provides all the features needed for a positive hot-swap controller. These features include:

- Undervoltage lockout
- Adjustable (system-level) enable
- Turn-on inrush limiting
- High-side gate drive for an external N-channel MOSFET
- MOSFET protection by power limiting
- Adjustable overload timeout, also called an electronic circuit breaker
- Charge-complete indicator for downstream converter coordination
- A choice of latch or automatic restart mode
- A low-power disable mode accessed by holding ENSD low
- MOSFET short detection
- Load overvoltage protection

The typical application diagram, shown on the front page of this datasheet, and oscilloscope plots, shown in [Figure 29](#) through [Figure 31](#) and [Figure 33](#) through [Figure 36](#), demonstrate many of the functions described previously.

### 7.4.1 Board Plug-In

[Figure 29](#) and [Figure 30](#) illustrate the inrush current that flows when a hot swap board under the control of the TPS24720 is plugged into a system bus. Only the bypass capacitor charge current and small bias currents are evident when a board is first plugged in. The TPS24720 is held inactive for a short period while internal voltages stabilize. In this short period, GATE, PROG, and TIMER are held low and PGB, FLTB, and FFLTb are held open-drain. When the voltage on the internal VCC rail exceeds approximately 1.5 V, the power-on reset (POR) circuit initializes the TPS24720 and a start-up cycle is ready to take place.

GATE, PROG, TIMER, PGB, FLTB and FFLTb are released after the internal voltages have stabilized and the external EN (enable) thresholds have been exceeded. The part begins sourcing current from the GATE pin to turn on MOSFET  $M_1$ . The TPS24720 monitors both the drain-to-source voltage across MOSFET  $M_1$  and the drain current passing through it. Based on these measurements, the TPS24720 limits the drain current by controlling the gate voltage so that the power dissipation within the MOSFET does not exceed the power limit programmed by the user. The current increases as the voltage across the MOSFET decreases until finally the current reaches the current limit  $I_{LIM}$ .

## Device Functional Modes (continued)

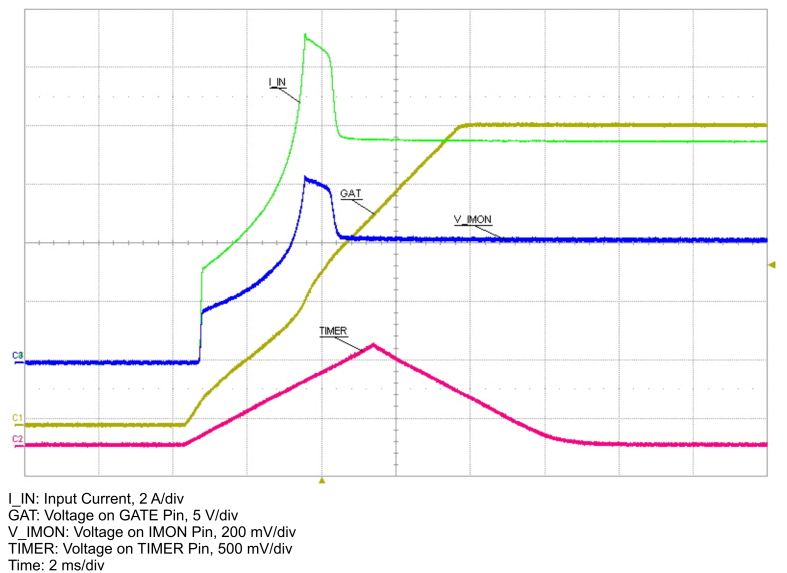

C001

**Figure 29. Inrush Mode at Hot-Swap Circuit Insertion**

### 7.4.2 Inrush Operation

After TPS24720 initialization is complete (as described in the [Board Plug-In](#) section) and EN is active, GATE is enabled ( $V_{GATE}$  starts increasing). When  $V_{GATE}$  reaches the MOSFET M1 gate threshold, a current flows into the downstream bulk storage capacitors. When this current exceeds the limit set by the power-limit engine, the gate of the MOSFET is regulated by a feedback loop to make the MOSFET current rise in a controlled manner. This not only limits the capacitor-charging inrush current but it also limits the power dissipation of the MOSFET to safe levels. A more complete explanation of the power-limiting scheme is given in the section entitled [Action of the Constant-Power Engine](#). When GATE is enabled, the TIMER pin begins to charge the timing capacitor  $C_T$  with a current of approximately  $10\ \mu\text{A}$ . The TIMER pin continues to charge  $C_T$  until  $V_{(GATE - V_{CC})}$  reaches the timer activation voltage (5.9 V for  $V_{VCC} = 12\ \text{V}$ ). The TIMER then begins to discharge  $C_T$  with a current of approximately  $10\ \mu\text{A}$ . This indicates that the inrush mode is finished. If the TIMER exceeds its upper threshold of 1.35 V before  $V_{(GATE - V_{CC})}$  reaches the timer activation voltage, the GATE pin is pulled to GND and the hot-swap circuit enters either latch mode or auto-retry mode, depending upon the status of the LATCH pin (see [LATCH](#)).

The power limit feature is disabled once the inrush operation is finished and the hotswap circuit becomes a circuit breaker. The TPS24720 turns off the MOSFET M1 after a fault timer period once the load exceeds the current limit threshold.

### 7.4.3 Action of the Constant-Power Engine

[Figure 30](#) illustrates the operation of the constant-power engine during start-up. The circuit used to generate the waveforms of [Figure 30](#) was programmed to a power limit of 29.3 W by means of the resistor connected between PROG and GND. At the moment current begins to flow through the MOSFET, a voltage of 12 V appears across it (input voltage  $V_{VCC} = 12\ \text{V}$ ), and the constant-power engine therefore allows a current of 2.44 A (equal to 29.3 W divided by 12 V) to flow. This current increases in inverse ratio as the drain-to-source voltage diminishes, so as to maintain a constant dissipation of 29.3 W. The constant-power engine adjusts the current by altering the reference signal fed to the current limit amplifier. The lower part of [Figure 31](#) shows the measured power dissipated within the MOSFET, labeled *FET PWR*, remaining substantially constant during this period of operation, which ends when the current through the MOSFET reaches the current limit  $I_{LIM}$ . This behavior can be considered a form of foldback limiting, but unlike the standard linear form of foldback limiting, it allows the power device to operate near its maximum capability, thus reducing the start-up time and minimizing the size of the required MOSFET.

## Device Functional Modes (continued)

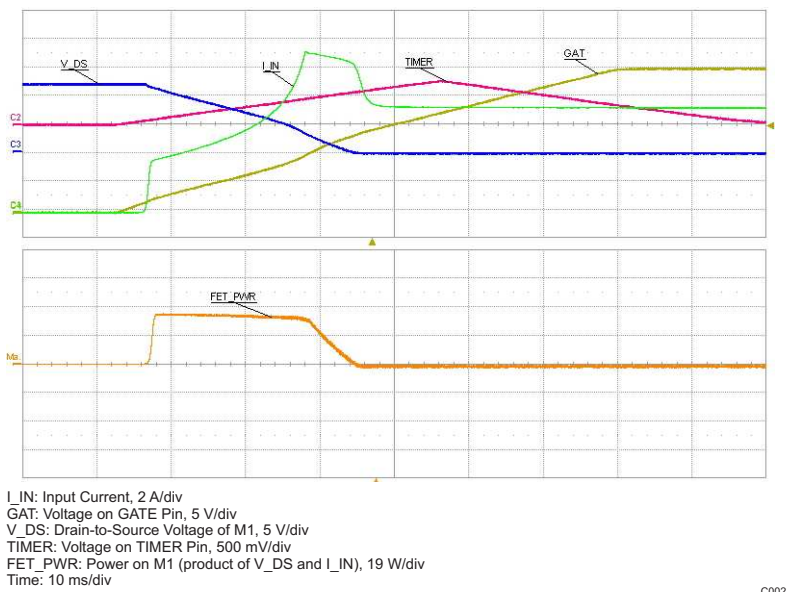

Figure 30. Computation of M<sub>1</sub> Power Stress During Startup

### 7.4.4 Circuit Breaker and Fast Trip

The TPS24720 monitors load current by sensing the voltage across  $R_{SENSE}$ . The TPS24720 incorporates two distinct thresholds: a current-limit threshold and a fast-trip threshold.

The functions of circuit breaker and fast-trip turn off are shown in [Figure 31](#) through [Figure 34](#).

[Figure 31](#) shows the behavior of the TPS24720 when a fault in the output load causes the current passing through  $R_{SENSE}$  to increase to a value above the current limit but less than the fast-trip threshold. When the current exceeds the current-limit threshold, a current of approximately 10  $\mu$ A begins to charge timing capacitor  $C_T$ . If the voltage on  $C_T$  reaches 1.35 V, then the external MOSFET is turned off. The TPS24720 either latches off or commences a restart cycle, depending upon the state of the LATCH pin. In either event, fault pin FLTb pulls low to signal a fault condition. Overload between the current limit and the fast-trip threshold is permitted for this period. This shutdown scheme is sometimes called an electronic circuit breaker.

The fast-trip threshold protects the system against a severe overload or a dead short circuit. When the voltage across the sense resistor  $R_{SENSE}$  exceeds the 60-mV fast-trip threshold, the GATE pin immediately pulls the external MOSFET gate to ground with approximately 1 A of current. This extremely rapid shutdown may generate disruptive transients in the system, in which case a low-value resistor inserted between the GATE pin and the MOSFET gate can be used to moderate the turn off current. The fast-trip circuit holds the MOSFET off for only a few microseconds, after which the TPS24720 turns back on slowly, allowing the current-limit feedback loop to take over the gate control of M<sub>1</sub>. Then the hot-swap circuit goes into latch mode or auto-retry mode, depending on pre-determined conditions. [Figure 33](#) and [Figure 34](#) illustrate the behavior of the system when the current exceeds the fast-trip threshold.

Device Functional Modes (continued)

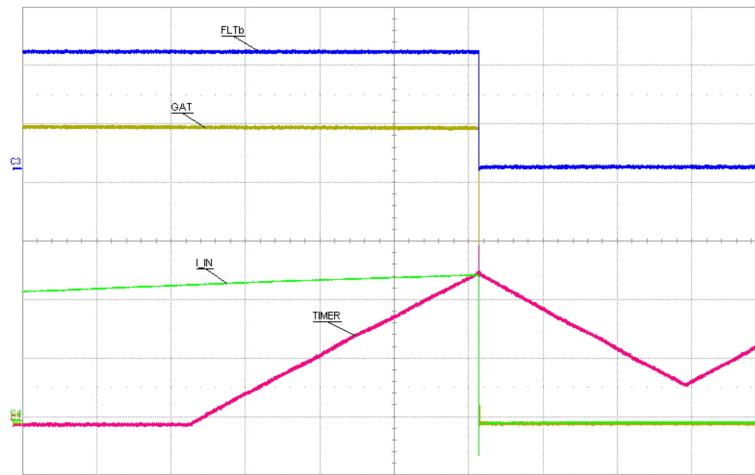

I<sub>IN</sub>: Input Current, 5 A/div  
 GAT: Voltage on GATE Pin, 5 V/div  
 FLTb: Voltage on FLTb Pin, 2 V/div  
 TIMER: Voltage on TIMER Pin, 500 mV/div  
 Time: 2 ms/div

C003

Figure 31. Circuit-Breaker Mode During Overload Condition

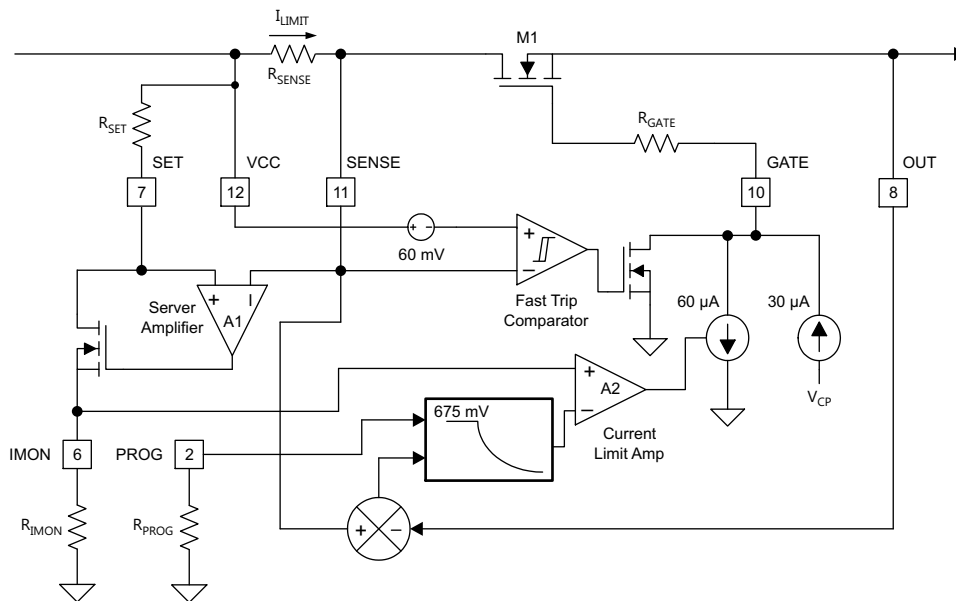

B0439-01

Copyright © 2016, Texas Instruments Incorporated

Figure 32. Partial Diagram of the TPS24720 With Selected External Components

Device Functional Modes (continued)

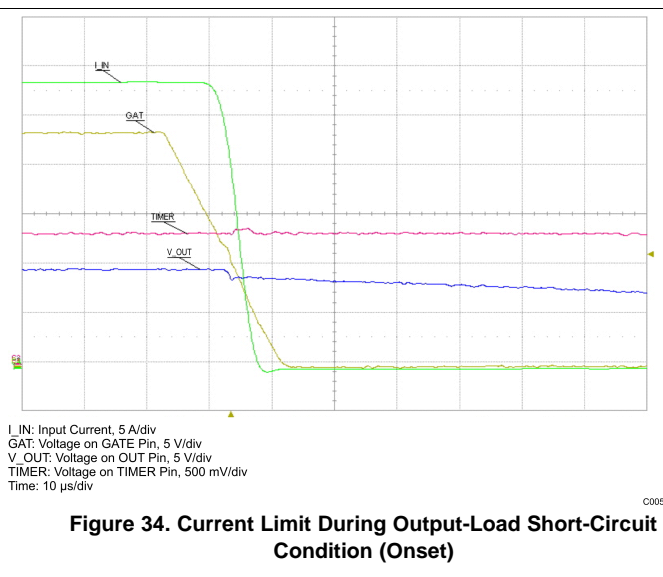
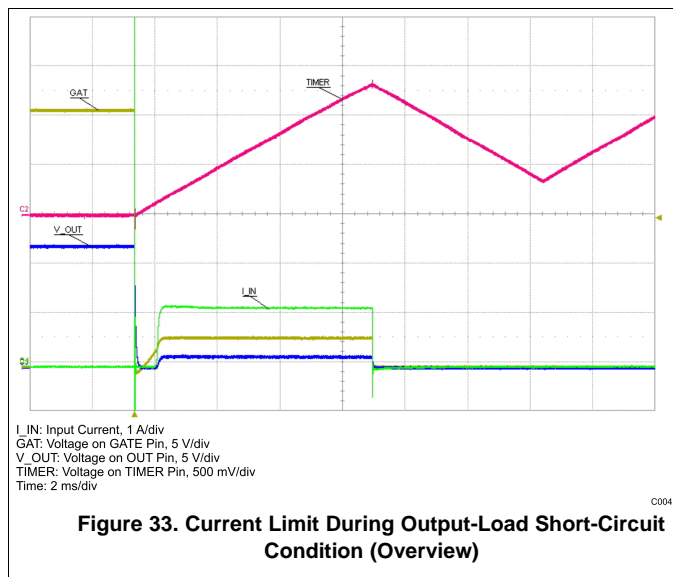

7.4.5 Automatic Restart

If LATCH is connected to GND, then the TPS24720 automatically initiates a restart after a fault has caused it to turn off the external MOSFET  $M_1$ . Internal control circuits use  $C_T$  to count 16 cycles before re-enabling  $M_1$  as shown in Figure 35. This sequence repeats if the fault persists. The timer has a 1 : 1 charge-to-discharge current ratio. For the very first cycle, the TIMER pin starts from 0 V and rises to the upper threshold of 1.35 V and subsequently falls to 0.35 V before restarting. For the following 16 cycles, 0.35 V is used as the lower threshold. This small duty cycle often reduces the average short-circuit power dissipation to levels associated with normal operation and eliminates special thermal considerations for surviving a prolonged output short.

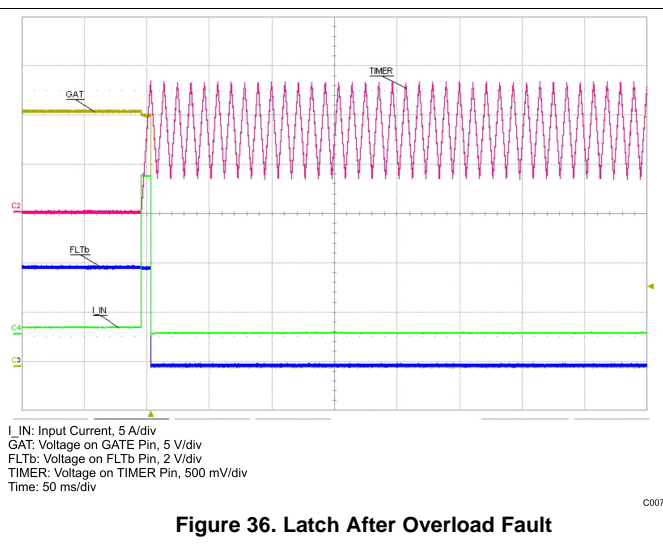
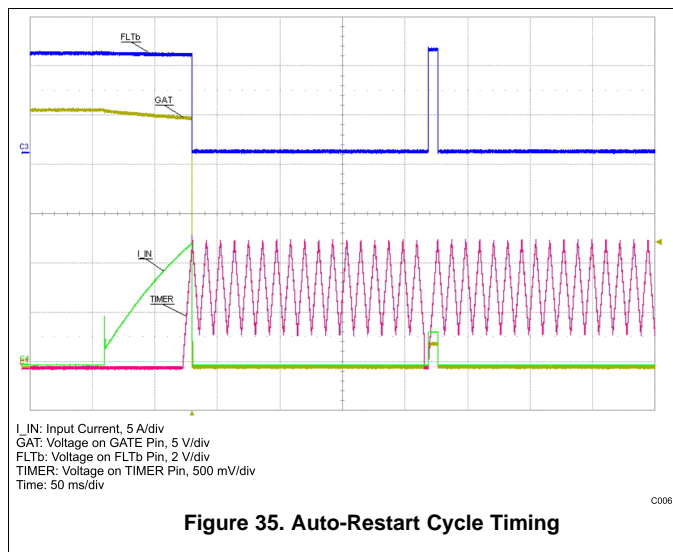

## Device Functional Modes (continued)

### 7.4.6 PGb, FLTb, and Timer Operations

The open-drain PGb output provides a deglitched end-of-inrush indication based on the voltage across  $M_1$ . PGb is useful for preventing a downstream dc/dc converter from starting while its input capacitor  $C_{OUT}$  is still charging. PGb goes active-low about 3.4 ms after  $C_{OUT}$  is charged. This delay allows  $M_1$  to fully turn on and any transients in the power circuits to end before the converter starts up. This type of sequencing prevents the downstream converter from demanding full current before the power-limiting engine allows the MOSFET to conduct the full current set by the current limit  $I_{LIM}$ . Failure to observe this precaution may prevent the system from starting. The pullup resistor shown on the PGb pin in the typical application diagram on the front page is illustrative only; the actual connection to the converter depends on the application. The PGb pin may indicate that inrush has ended before the MOSFET is fully enhanced, but the downstream capacitor will have been charged to substantially its full operating voltage. Care should be taken to ensure that the MOSFET on-resistance is sufficiently small to ensure that the voltage drop across this transistor is less than the minimum power-good threshold of 140 mV. After the hot-swap circuit successfully starts up, the PGb pin can return to a high-impedance status whenever the drain-to-source voltage of MOSFET  $M_1$  exceeds its upper threshold of 340 mV, which presents the downstream converters a warning flag. This flag may occur as a result of overload fault, output short fault, input overvoltage, higher die temperature, or the GATE shutdown by UVLO, EN or ENSD.

FLTb is an indicator that the allowed fault-timer period during which the load current can exceed the programmed current limit (but not the fast-trip threshold) expires. The fault timer starts when a current of approximately 10  $\mu$ A begins to flow into the external capacitor,  $C_T$ , and ends when the voltage of  $C_T$  reaches TIMER upper threshold, i.e., 1.35 V. FLTb pulls low at the end of the fault timer. Otherwise, FLTb assumes a high-impedance state.

The fault-timer state requires an external capacitor  $C_T$  connected between the TIMER pin and GND pin. The duration of the fault timer is the charging time of  $C_T$  from 0 V to its upper threshold of 1.35 V. The fault timer begins to count under any of the following three conditions:

1. In the inrush mode, TIMER begins to source current to the timer capacitor,  $C_T$ , when MOSFET  $M_1$  is enabled. TIMER begins to sink current from the timer capacitor,  $C_T$  when  $V_{(GATE - VCC)}$  exceeds the timer activation voltage (see the *Inrush Operation* section). If  $V_{(GATE - VCC)}$  does not reach the timer activation voltage before TIMER reaches 1.35 V, then the TPS24720 disables the external MOSFET  $M_1$ . After the MOSFET turns off, the timer goes into either latch mode or retry mode, depending on the LATCH pin status.
2. In an overload fault, TIMER begins to source current to the timer capacitor,  $C_T$ , when the load current exceeds the programmed current limits. When the timer capacitor voltage reaches its upper threshold of 1.35 V, TIMER begins to sink current from the timer capacitor,  $C_T$ , and the GATE pin is pulled to ground. After the fault timer period, TIMER may go into latch mode or retry mode, depending on the LATCH pin status.
3. In output short-circuit fault, TIMER begins to source current to the timer capacitor,  $C_T$ , when the load current exceeds the programmed current limits following a fast-trip shutdown of  $M_1$ . When the timer capacitor voltage reaches its upper threshold of 1.35 V, TIMER begins to sink current from the timer capacitor,  $C_T$ , and the GATE pin is pulled to ground. After the fault timer period, TIMER may go into latch mode or retry mode, depending on the LATCH pin status.

If the fault current drops below the programmed current limit within the fault timer period,  $V_{TIMER}$  decreases and the pass MOSFET remains enabled.

The behaviors of TIMER are different in the latch mode and retry mode. If the timer capacitor reaches the upper threshold of 1.35 V, then:

- In latch mode, the TIMER pin continues to charge and discharge the attached capacitor periodically until TPS24720 is disabled by UVLO, EN, ENSD, or OV, as shown in [Figure 36](#).
- In retry mode, TIMER charges and discharges  $C_T$  between the lower threshold of 0.35 V and the upper threshold of 1.35 V for sixteen cycles before the TPS24720 attempts to re-start. The TIMER pin is pulled to GND at the end of the 16<sup>th</sup> cycle of charging and discharging and then ramps from 0 V to 1.35 V for the initial half-cycle in which the GATE pin sources current. This periodic pattern is stopped once the overload fault is removed or the TPS24720 is disabled by UVLO, EN, ENSD, or OV.



## Device Functional Modes (continued)

### 7.4.7 Overtemperature Shutdown

The TPS24720 includes a built-in overtemperature shutdown circuit designed to disable the gate driver if the die temperature exceeds approximately 140°C. An overtemperature condition also causes the FLTb, FFLTb and PGb pins to go to high-impedance states. Normal operation resumes once the die temperature has fallen approximately 10°C.

### 7.4.8 Start-Up of Hot-Swap Circuit by VCC or EN

The connection and disconnection between a load and the input power bus are controlled by turning on and turning off the MOSFET, M<sub>1</sub>.

The TPS24720 has two ways to turn on MOSFET M<sub>1</sub>:

- Increasing V<sub>VCC</sub> above UVLO upper threshold while EN is already higher than its upper threshold sources current to the GATE pin. After an inrush period, the TPS24720 fully turns on MOSFET M<sub>1</sub>.
- Increasing EN above its upper threshold while V<sub>VCC</sub> is already higher than the UVLO upper threshold sources current to the GATE pin. After an inrush period, the TPS24720 fully turns on MOSFET M<sub>1</sub>.

The EN pin can be used to start up the TPS24720 at a selected input voltage V<sub>VCC</sub>.

To isolate the load from the input power bus, the GATE pin sinks current and pulls the gate of MOSFET M<sub>1</sub> low. The MOSFET can be disabled by any of the following conditions: UVLO, EN, ENSD, load current above the current-limit threshold, hard short at load, OV, or OTSD. Three separate mechanisms pull down the GATE pin:

1. GATE is pulled down by an 11-mA current source when any of the following occurs.
  - The fault timer expires during an overload current fault (V<sub>IMON</sub> > 675 mV).
  - V<sub>EN</sub> is below its falling threshold.
  - V<sub>VCC</sub> drops below the UVLO threshold.
  - V<sub>OV</sub> is above its rising threshold.
2. GATE is pulled down by a 1-A current source for 13.5 μs when a hard output short circuit occurs and V<sub>(VCC – SENSE)</sub> is greater than 60 mV, i.e., the fast-trip shutdown threshold. After fast-trip shutdown is complete, an 11-mA sustaining current ensures that the external MOSFET remains off.
3. GATE is discharged by a 20-kΩ resistor to GND if the chip die temperature exceeds the OTSD rising threshold or ENSD is pulled low.

### 7.4.9 Minimization of Power Dissipation at STANDBY by ENSD

The ENSD pin enables the use of TPS24720 in applications requiring a low-power standby mode. When this pin is pulled below its threshold voltage, all the internal circuitry is switched off and the GATE pin is discharged to GND through a 20-kΩ resistor. Thus, the MOSFET is disabled and power consumption is kept to a minimum. The correct procedure to go into standby mode is first to shut down the TPS24720 by using the EN pin and then to pull the ENSD pin low.

### 7.4.10 Fault Detection of MOSFET Short With FFLTb

One of the salient features of the TPS24720 is the detection of short-circuited MOSFETs by the FFLTb pin. The FFLTb is pulled low to indicate a FET short if all the following conditions occur.

- EN is below its threshold voltage.
- V<sub>VCC</sub> is above the UVLO threshold.
- V<sub>IMON</sub> > 103 mV.

The fact that GATE is turned off but current is still flowing through R<sub>SENSE</sub> indicates a drain-to-source short.

## 8 Application and Implementation

### NOTE

Information in the following applications sections is not part of the TI component specification, and TI does not warrant its accuracy or completeness. TI's customers are responsible for determining suitability of components for their purposes. Customers should validate and test their design implementation to confirm system functionality.

### 8.1 Application Information

The TPS24720 is a hotswap used to manage inrush current and provide load fault protection. When designing a hotswap, three key scenarios should be considered:

- Start-up
- Output of a hotswap is shorted to ground when the hotswap is on. This is often referred to as a hot-short.
- Powering-up a board when the output and ground are shorted. This is usually called a start-into-short.

Each of these scenarios place stress on the hotswap MOSFET. Take special care when designing the hotswap circuit to keep the MOSFET within its SOA. The following design example is provided as a guide. Use the TPS24720 Design Calculator ([SLVC563](#)) to assist with the detailed design equation calculations.

### 8.2 Typical Application

This section provides an application example utilizing power limited start-up and MOSFET SOA protection. The design parameters are listed in the [Design Requirements](#) section and represent a more moderate level of fault current. For more stringent current levels, refer to either the TPS24720EVM ([SLUU458](#)) (25 A design) or the calculator tool ([SLVC563](#)) (50 A design).

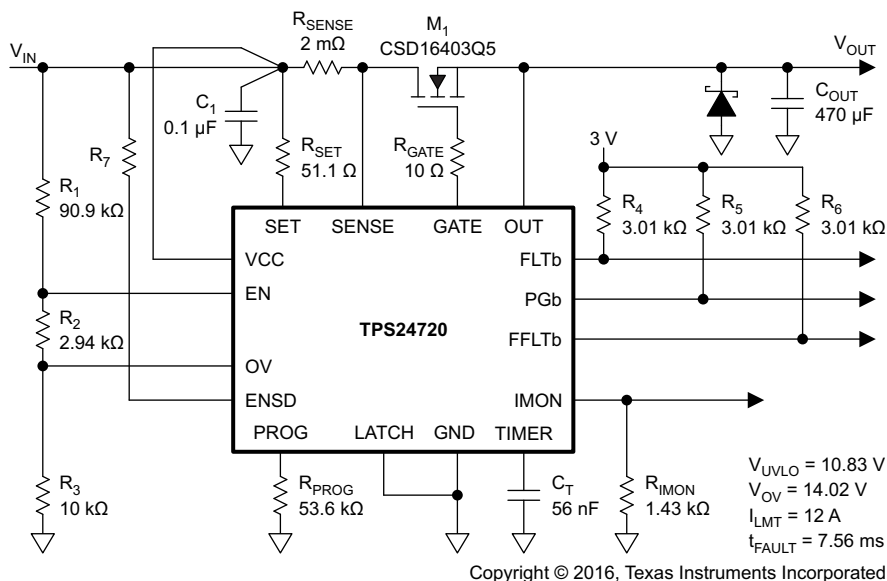

Figure 37. Typical Application (12 V at 10 A)



## Typical Application (continued)

### 8.2.1 Design Requirements

For this design example, use the parameters shown in [Table 1](#).

**Table 1. Design Parameters**

PARAMETER	VALUE
Input voltage	12 V $\pm$ 2V
Maximum operating load current	10 A
Operating temperature	20°C –50°C
Fault trip current	12 A
Load capacitance	470 $\mu$ F

### 8.2.2 Detailed Design Procedure

#### 8.2.2.1 Power-Limited Start-Up

This design example assumes a 12-V system voltage with an operating tolerance of  $\pm 2$  V. The rated load current is 10 A, corresponding to a dc load of 1.2  $\Omega$ . If the current exceeds 12 A, then the controller should shut down and then attempt to restart. Ambient temperatures may range from 20°C to 50°C. The load has a minimum input capacitance of 470  $\mu$ F. [Figure 38](#) shows a simplified system block diagram of the proposed application.

This design procedure seeks to control the junction temperature of MOSFET  $M_1$  under both static and transient conditions by proper selection of package, cooling,  $r_{DS(on)}$ , current limit, fault timeout, and power limit. The design procedure further assumes that a unit running at full load and maximum ambient temperature experiences a brief input power interruption sufficient to discharge  $C_{OUT}$ , but short enough to keep  $M_1$  from cooling. A full  $C_{OUT}$  recharge then takes place. Adjust this procedure to fit the application and design criteria.

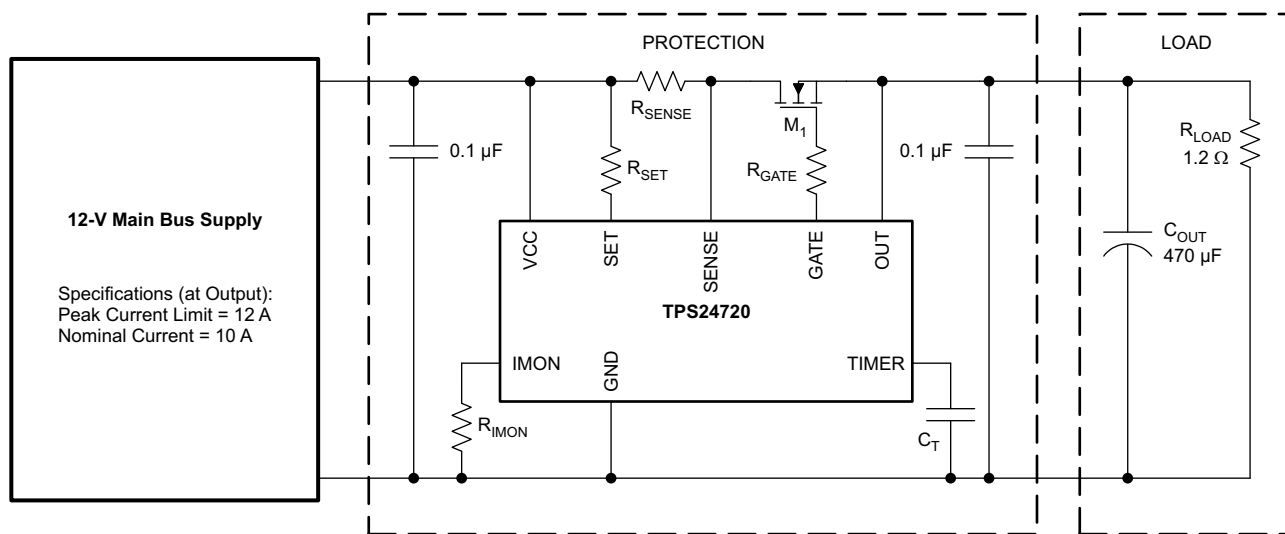

B0440-01

Copyright © 2016, Texas Instruments Incorporated

**Figure 38. Simplified Block Diagram of the System Constructed in the Design Example**

#### 8.2.2.1.1 STEP 1. Choose $R_{SENSE}$ , $R_{SET}$ , and $R_{IMON}$

The recommended range of the current-limit threshold voltage,  $V_{(VCC - SENSE)}$ , extends from 10 mV to 42 mV. Values near the low threshold of 10 mV may be affected by system noise. Values near the upper threshold of 42 mV may be too close to the minimum fast-trip threshold voltage of 52 mV. Values near the middle of this range help minimize both concerns.

To achieve high efficiency, the power dissipation in  $R_{\text{SENSE}}$  must be kept to a minimum. A  $R_{\text{SENSE}}$  of 2 m $\Omega$  develops a voltage of 24 mV at the specified peak current limit of 12 A, while dissipating only 200 mW at the rated 10-A current. This represents a 0.17% power loss.

For best performance, a current of approximately 0.5 mA (referring to the RECOMMENDED OPERATING CONDITIONS table) should flow into the SET pin and out of the IMON pin when the TPS24720 is in current limit. The voltage across  $R_{\text{SET}}$  nominally equals the voltage across  $R_{\text{SENSE}}$ , or 24 mV. Dividing 24 mV by 0.5 mA gives a recommended value of  $R_{\text{SET}}$  of 48  $\Omega$ . A 51.1- $\Omega$ , 1% resistor was chosen. Using Equation 3, the value of  $R_{\text{IMON}}$  must equal 1437  $\Omega$ , or as near as practically possible. A 1.43-k $\Omega$ , 1% resistor was chosen.

$$R_{\text{IMON}} = \frac{0.675 \text{ V} \times R_{\text{SET}}}{I_{\text{LIM}} \times R_{\text{SENSE}}},$$

therefore,

$$R_{\text{IMON}} = \frac{0.675 \text{ V} \times 51.1 \Omega}{12 \text{ A} \times 2 \text{ m}\Omega} = 1437 \Omega \quad (5)$$

### 8.2.2.1.2 STEP 2. Choose MOSFET $M_1$

The next design step is to select  $M_1$ . The TPS24720 is designed to use an N-channel MOSFET with a gate-to-source voltage rating of 20 V.

Devices with lower gate-to-source voltage ratings can be used if a Zener diode is connected so as to limit the maximum gate-to-source voltage the transistor sees.

The next factor to consider is the drain-to-source voltage rating,  $V_{\text{DS(MAX)}}$ , of the MOSFET. Although the MOSFET only sees 12 V dc, it may experience much higher transient voltages during extreme conditions, such as the abrupt shutoff that occurs during a fast trip. A TVS may be required to limit inductive transients under such conditions. A transistor with a  $V_{\text{DS(MAX)}}$  rating of at least twice the nominal input power-supply voltage is recommended regardless of whether a TVS is used or not.

Next select the on-resistance of the transistor,  $r_{\text{DS(on)}}$ . The maximum on-resistance must not generate a voltage greater than the minimum power-good threshold voltage of 140 mV. Assuming a current limit of 12 A, a maximum  $r_{\text{DS(on)}}$  of 11.67 m $\Omega$  is required. Also consider the effect of  $r_{\text{DS(on)}}$  on the maximum operating temperature  $T_{\text{J(MAX)}}$  of the MOSFET. Equation 6 computes the value of  $r_{\text{DS(on)(MAX)}}$  at a junction temperature of  $T_{\text{J(MAX)}}$ . Most manufacturers list  $r_{\text{DS(on)(MAX)}}$  at 25°C and provide a derating curve from which values at other temperatures can be derived. Compute the maximum allowable on-resistance,  $r_{\text{DS(on)(MAX)}}$ , using Equation 6.

$$r_{\text{DS(on)(MAX)}} = \frac{T_{\text{J(MAX)}} - T_{\text{A(MAX)}}}{I_{\text{MAX}}^2 \times R_{\theta\text{JA}}},$$

therefore,

$$r_{\text{DS(on)(MAX)}} = \frac{150^\circ\text{C} - 50^\circ\text{C}}{(12 \text{ A})^2 \times 51^\circ\text{C/W}} = 13.6 \text{ m}\Omega \quad (6)$$

Taking these factors into consideration, the TI CSD16403Q5 was selected for this example. This transistor has a  $V_{\text{GS(MAX)}}$  rating of 16 V, a  $V_{\text{DS(MAX)}}$  rating of 25 V, and a maximum  $r_{\text{DS(on)}}$  of 2.8 m $\Omega$  at room temperature. During normal circuit operation, the MOSFET can have up to 10 A flowing through it. The power dissipation of the MOSFET equates to 0.24 W and an 9.6°C rise in junction temperature. This is well within the data sheet limits for the MOSFET. The power dissipated during a fault (e.g., output short) is far larger than the steady-state power. The power handling capability of the MOSFET must be checked during fault conditions.

### 8.2.2.1.3 STEP 3. Choose Power-Limit Value, $P_{\text{LIM}}$ , and $R_{\text{PROG}}$

MOSFET  $M_1$  dissipates large amounts of power during inrush. The power limit  $P_{\text{LIM}}$  of the TPS24720 should be set to prevent the die temperature from exceeding a short-term maximum temperature,  $T_{\text{J(MAX)2}}$ . The short-term  $T_{\text{J(MAX)2}}$  could be set as high as 150°C while still leaving ample margin to the usual manufacturer's rating of 175°C. Equation 7 is an expression for calculating  $P_{\text{LIM}}$ .

$$P_{LIM} \leq 0.8 \times \frac{T_{J(MAX)2} - \left[ \left( I_{MAX}^2 \times r_{DS(on)} \times R_{\theta CA} \right) + T_{A(MAX)} \right]}{R_{\theta JC}}$$

therefore,

$$P_{LIM} \leq 0.8 \times \frac{130^\circ\text{C} - \left[ \left( (12\text{ A})^2 \times 0.002\ \Omega \times (51^\circ\text{C/W} - 1.8^\circ\text{C/W}) \right) + 50^\circ\text{C} \right]}{1.8^\circ\text{C/W}} = 29.3\text{ W} \quad (7)$$

where  $R_{\theta JC}$  is the junction-to-case thermal resistance of the MOSFET,  $r_{DS(on)}$  is its resistance at the maximum operating temperature, and the factor of 0.8 represents the tolerance of the constant-power engine. For an ambient temperature of 50°C, the calculated maximum  $P_{LIM}$  is 29.3 W. From Equation 1, a 53.6-kΩ, 1% resistor is selected for  $R_{PROG}$  (see Equation 8).

$$R_{PROG} = \frac{84375}{P_{LIM} \times R_{SENSE}} \times \frac{R_{SET}}{R_{IMON}}$$

therefore,

$$R_{PROG} = \frac{84375}{29.3\text{ W} \times 0.002\ \Omega} \times \frac{51.1\ \Omega}{1430\ \Omega} = 51.45\text{ k}\Omega \quad (8)$$

Power limit fold back ( $P_{LIM-FB}$ ) is the ratio of operating current limit ( $I_{LIM}$ ) and minimum power limited (regulated) current (when  $V_{OUT} = 0\text{ V}$ ). Degradation of programmed power limit ( $P_{LIM}$ ) accuracy and start up issues may occur if  $P_{LIM-FB}$  is too large. Equation 9 calculates  $V_{SNS-PL\_MIN}$  (minimum sense voltage during power limit) and  $P_{LIM-FB}$ . To ensure reliable operation, verify that  $P_{LIM-FB} < 10$  and  $V_{SNS-PL\_MIN} > 3\text{ mV}$ .

$$V_{SNS-PL\_MIN} = \frac{P_{LIM} \times R_{SENSE}}{V_{IN\_MAX}} = \frac{29.3\text{ W} \times 2\text{ m}\Omega}{14\text{ V}} = 4.19\text{ mV} (> 3\text{ mV})$$

$$P_{LIM-FB} = \frac{I_{LIM} \times V_{IN\_MAX}}{P_{LIM}} = \frac{12\text{ A} \times 14\text{ V}}{29.3\text{ W}} = 5.73 (< 10) \quad (9)$$

#### 8.2.2.1.4 STEP 4. Choose Output Voltage Rising Time, $t_{ON}$ , and Timing Capacitor $C_T$

The maximum output voltage rise time,  $t_{ON}$ , set by timer capacitor  $C_T$  must suffice to fully charge the load capacitance  $C_{OUT}$  without triggering the fault circuitry. Equation 10 defines  $t_{ON}$  for two possible inrush cases. Assuming that only the load capacitance draws current during startup,

$$t_{ON} = \begin{cases} \frac{C_{OUT} \times P_{LIM}}{2 \times I_{LIM}^2} + \frac{C_{OUT} \times V_{VCC(MAX)}^2}{2 \times P_{LIM}} - \frac{C_{OUT} \times V_{VCC(MAX)}}{I_{LIM}} & \text{if } P_{LIM} < I_{LIM} \times V_{VCC(MAX)} \\ \frac{C_{OUT} \times V_{VCC(MAX)}}{I_{LIM}} & \text{if } P_{LIM} > I_{LIM} \times V_{VCC(MAX)} \end{cases}$$

therefore,

$$t_{ON} = \frac{470\ \mu\text{F} \times 29.3\text{ W}}{2 \times (12\text{ A})^2} + \frac{470\ \mu\text{F} \times (12\text{ V})^2}{2 \times 29.3\text{ W}} - \frac{470\ \mu\text{F} \times 12\text{ V}}{12\text{ A}} = 0.614\text{ ms} \quad (10)$$

The next step is to determine the minimum fault-timer period. In [Equation 10](#), the output rise time is  $t_{ON}$ . This is the amount of time it takes to charge the output capacitor up to the final output voltage. However, the fault timer uses the difference between the input voltage and the gate voltage to determine if the TPS24720 is still in inrush limit. The fault timer continues to run until  $V_{GS}$  rises 5.9 V (for  $V_{VCC} = 12$  V) above the input voltage. Some additional time must be added to the charge time to account for this additional gate voltage rise. The minimum fault time can be calculated using [Equation 11](#),

$$t_{FLT} = t_{ON} + \frac{5.9 \text{ V} \times C_{ISS}}{I_{GATE}},$$

therefore,

$$t_{FLT} = 0.614 \text{ ms} + \frac{5.9 \text{ V} \times 2040 \text{ pF}}{20 \text{ } \mu\text{A}} = 1.22 \text{ ms} \quad (11)$$

where  $C_{ISS}$  is the MOSFET input capacitance and  $I_{GATE}$  is the minimum gate sourcing current of TPS24720, or 20  $\mu\text{A}$ . Using the example parameters and the CSD16403Q5 data sheet in [Equation 11](#) leads to a minimum fault time of 1.22 ms. This time is derived considering the tolerances of  $C_{OUT}$ ,  $C_{ISS}$ ,  $I_{LIM}$ ,  $P_{LIM}$ ,  $I_{GATE}$ , and  $V_{VCC(MAX)}$ . The fault timer must be set to a value higher than 1.22 ms to avoid turning off during start-up, but lower than any maximum fault time limit determined by the device SOA curve (see [Figure 39](#)) derated for operating junction temperature.

For this example, select 7 ms to allow for variation of system parameters such as temperature, load, component tolerance, and input voltage. The timing capacitor is calculated in [Equation 12](#) as 52 nF. Selecting the next-highest standard value, 56 nF, yields a 7.56-ms fault time.

$$C_T = \frac{10 \text{ } \mu\text{A}}{1.35 \text{ V}} \times t_{FLT},$$

therefore,

$$C_T = \frac{10 \text{ } \mu\text{A}}{1.35 \text{ V}} \times 7 \text{ ms} = 52 \text{ nF} \quad (12)$$

#### 8.2.2.1.5 STEP 5. Calculate the Retry-Mode Duty Ratio

In retry mode, the TPS24720 is on for one charging cycle and off for 16 charge/discharge cycles, as can be seen in [Figure 35](#). The first  $C_T$  charging cycle is from 0 V to 1.35 V, which gives 7.56 ms. The first  $C_T$  discharging cycle is from 1.35 V to 0.35 V, which gives 5.6 ms. Therefore, the total time is 7.56 ms + 33 x 5.6 ms = 192.36 ms. As a result, the retry mode duty ratio is 7.56 ms/192.36 ms = 3.93%.

#### 8.2.2.1.6 STEP 6. Select $R_1$ , $R_2$ , and $R_3$ for UV and OV

Next, select the values of the OV and UV resistors,  $R_1$ ,  $R_2$ , and  $R_3$ , as shown in the typical application diagram on the front page. From the TPS24720 electrical specifications,  $V_{OVTHRESH} = 1.35$  V and  $V_{ENTHRESH} = 1.35$  V.  $V_{OV}$  is the overvoltage trip voltage, which in this case is 14 V.  $V_{UV}$  is the undervoltage trip voltage, which for this example equals 10.8 V.

$$V_{ENTHRESH} = \frac{R_3}{R_1 + R_2 + R_3} \times V_{OV} \quad (13)$$

$$V_{UVTHRESH} = \frac{R_2 + R_3}{R_1 + R_2 + R_3} \times V_{UV} \quad (14)$$

Assume  $R_3$  is 1 k $\Omega$  and use [Equation 13](#) to solve for  $(R_2 + R_3)$ . Use [Equation 14](#) and the  $(R_2 + R_3)$  from [Equation 13](#) to solve for  $R_2$  and finally for  $R_3$ . From [Equation 13](#),  $(R_2 + R_3) = 9370.4 \text{ } \Omega$ . From [Equation 14](#),  $R_2 = 296 \text{ } \Omega$  and  $R_1 = 9.074 \text{ k}\Omega$ . Scaling all three resistors by a factor of ten to use less supply current for these voltage references and using standard 1% resistor values gives  $R_1 = 90.9 \text{ k}\Omega$ ,  $R_2 = 2.94 \text{ k}\Omega$ , and  $R_3 = 10 \text{ k}\Omega$ .

### 8.2.2.1.7 STEP 7. Choose $R_{GATE}$ , $R_4$ , $R_5$ , $R_6$ , and $C_1$

In the typical application diagram on the front page, the gate resistor,  $R_{GATE}$ , is intended to suppress high-frequency oscillations. A resistor of 10  $\Omega$  serves for most applications, but if  $M_1$  has a  $C_{ISS}$  below 200 pF, then 33  $\Omega$  is recommended. Applications with larger MOSFETs and very short wiring may not require  $R_{GATE}$ .  $R_4$ ,  $R_5$ , and  $R_6$  are required only if PGb, FLTb, and FFLTb are used; these resistors serve as pullups for the open-drain output drivers. The current sunk by each of these pins should not exceed 2 mA (referring to the [Recommended Operating Conditions](#)).  $C_1$  is a bypass capacitor to help control transient voltages, unit emissions, and local supply noise while in the disabled state. Where acceptable, a value in the range of 0.001  $\mu$ F to 0.1  $\mu$ F is recommended.

## 8.2.2.2 Additional Design Considerations

### 8.2.2.2.1 Use of PGb

Use the PGb pin to control and coordinate a downstream dc/dc converter. If this is not done, then a long time delay is needed to allow  $C_{OUT}$  to fully charge before the converter starts. An undesirable latch-up condition can be created between the TPS24720 output characteristic and the dc/dc converter input characteristic if the converter starts while  $C_{OUT}$  is still charging; using the PGb pin is one way to avoid this.

### 8.2.2.2.2 Output Clamp Diode

Inductive loads on the output may drive the OUT pin below GND when the circuit is unplugged or during a current-limit event. The OUT pin ratings can be satisfied by connecting a diode from OUT to GND. The diode should be selected to control the negative voltage at the full short-circuit current. Schottky diodes are generally recommended for this application.

### 8.2.2.2.3 Gate Clamp Diode

The TPS24720 has a relatively well-regulated gate voltage of 12 V–15.5 V with a supply voltage  $V_{VCC}$  higher than 4 V. A small clamp Zener from gate to source of  $M_1$  is recommended if  $V_{GS}$  of  $M_1$  is rated below 12 V. A series resistance of several hundred ohms or a series silicon diode is recommended to prevent the output capacitance from discharging through the gate driver to ground.

### 8.2.2.2.4 High-Gate-Capacitance Applications

Gate voltage overstress and abnormally large fault-current spikes can be caused by large gate capacitance. An external gate clamp Zener diode is recommended to assist the internal Zener if the total gate capacitance of  $M_1$  exceeds about 4000 pF.

### 8.2.2.2.5 Bypass Capacitors

It is a good practice to provide low-impedance ceramic capacitor bypassing of the VCC and OUT pins. Values in the range of 10 nF to 1  $\mu$ F are recommended. Some system topologies are insensitive to the values of these capacitors; however, some are not and require minimization of the value of the bypass capacitor. Input capacitance on a plug-in board may cause a large inrush current as the capacitor charges through the low-impedance power bus when inserted. This stresses the connector contacts and causes a short voltage sag on the input bus. Small amounts of capacitance (e.g., 10 nF to 0.1  $\mu$ F) are often tolerable in these systems.

### 8.2.2.2.6 Output Short-Circuit Measurements

Repeatable short-circuit testing results are difficult to obtain. The many details of source bypassing, input leads, circuit layout and component selection, output shorting method, relative location of the short, and instrumentation all contribute to variation in results. The actual short itself exhibits a certain degree of randomness as it microscopically bounces and arcs. Care in configuration and methods must be used to obtain realistic results. Do not expect to see waveforms exactly like those in the data sheet; every setup differs.

### 8.2.3 Application Curve

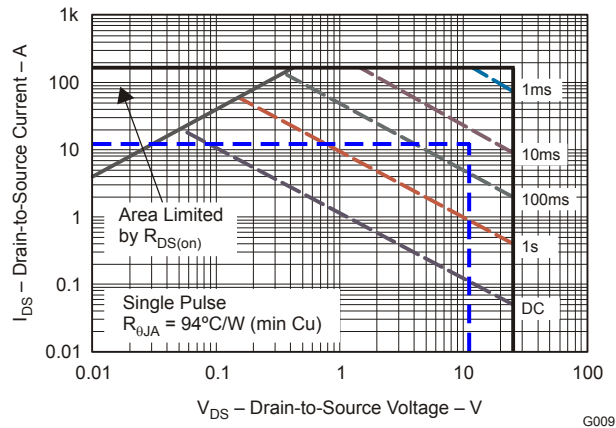

**Figure 39. CSD16403Q5 SOA Curve**

## 9 Power Supply Recommendations

Use a 10-nF to 1- $\mu\text{F}$  ceramic capacitor to bypass the VCC pin to GND. When the input bus power feed is inductive, then a transient voltage suppressor (TVS) may also be required.

## 10 Layout

### 10.1 Layout Guidelines

TPS24720 applications require careful attention to layout to ensure proper performance and to minimize susceptibility to transients and noise. In general, all traces should be as short as possible, but the following list deserves first consideration:

- Decoupling capacitors on VCC pin should have minimal trace lengths to the pin and to GND.
- Traces to SET and SENSE must be short and run side-by-side to maximize common-mode rejection. Kelvin connections should be used at the points of contact with  $R_{SENSE}$  (see Figure 40).
- SET runs must be short on both sides of  $R_{SET}$ .
- Power path connections should be as short as possible and sized to carry at least twice the full-load current, more if possible.
- Connections to GND and IMON pins should be minimized after the previously described connections have been placed.
- The device dissipates low power, so soldering the thermal pad to the board is not a requirement. However, doing so improves thermal performance and reduces susceptibility to noise.
- Protection devices such as snubbers, TVS, capacitors, or diodes should be placed physically close to the device they are intended to protect, and routed with short traces to reduce inductance. For example, the protection Schottky diode shown in the typical application diagram on the front page of the data sheet should be physically close to the OUT pin.

### 10.2 Layout Example

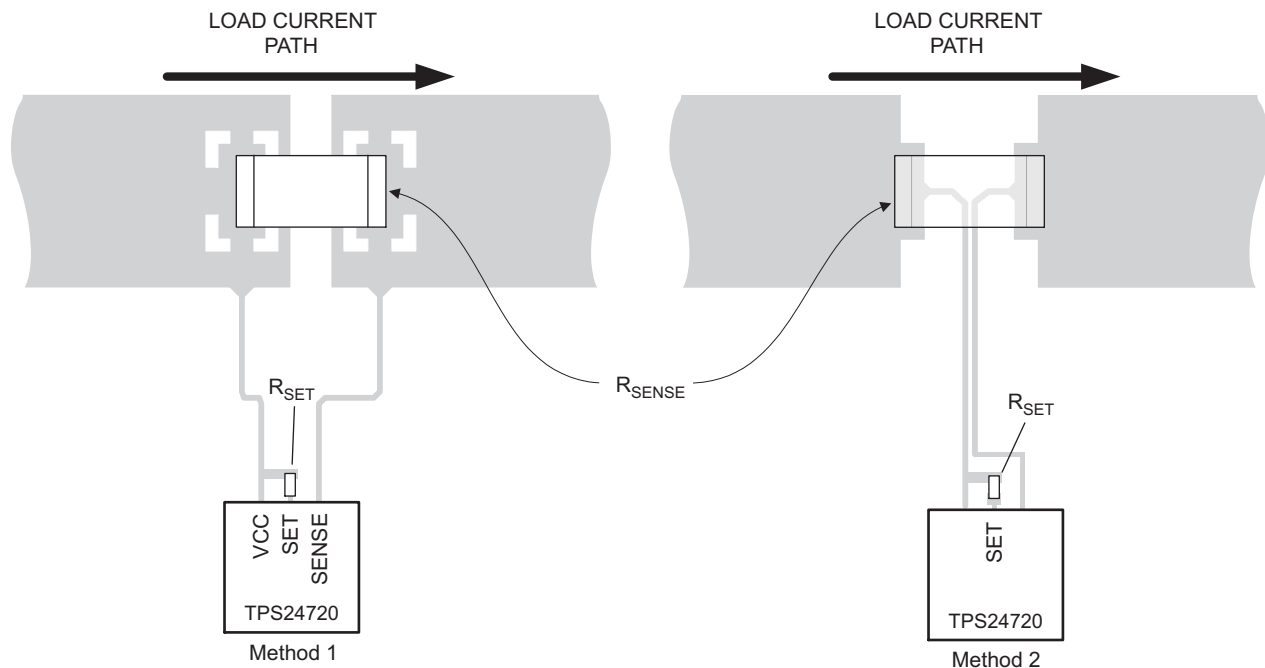

M0217-01

Figure 40. Recommended  $R_{SENSE}$  Layout

## 11 Device and Documentation Support

### 11.1 Documentation Support

Using the *TPS24720EVM*, [SLUU458](#).

*TPS24720 Design Calculator*, [SLVC563](#)

### 11.2 Trademarks

All trademarks are the property of their respective owners.

### 11.3 Electrostatic Discharge Caution



These devices have limited built-in ESD protection. The leads should be shorted together or the device placed in conductive foam during storage or handling to prevent electrostatic damage to the MOS gates.

### 11.4 Glossary

[SLYZ022](#) — *TI Glossary*.

This glossary lists and explains terms, acronyms, and definitions.

## 12 Mechanical, Packaging, and Orderable Information

The following pages include mechanical, packaging, and orderable information. This information is the most current data available for the designated devices. This data is subject to change without notice and revision of this document. For browser-based versions of this data sheet, refer to the left-hand navigation.



**PACKAGING INFORMATION**

Orderable Device	Status (1)	Package Type	Package Drawing	Pins	Package Qty	Eco Plan (2)	Lead/Ball Finish (6)	MSL Peak Temp (3)	Op Temp (°C)	Device Marking (4/5)	Samples
TPS24720RGTR	ACTIVE	VQFN	RGT	16	3000	Green (RoHS & no Sb/Br)	CU NIPDAU	Level-2-260C-1 YEAR	-40 to 85	24720	<a href="#">Samples</a>
TPS24720RGTT	ACTIVE	VQFN	RGT	16	250	Green (RoHS & no Sb/Br)	CU NIPDAU	Level-2-260C-1 YEAR	-40 to 85	24720	<a href="#">Samples</a>

(1) The marketing status values are defined as follows:

**ACTIVE:** Product device recommended for new designs.

**LIFEBUY:** TI has announced that the device will be discontinued, and a lifetime-buy period is in effect.

**NRND:** Not recommended for new designs. Device is in production to support existing customers, but TI does not recommend using this part in a new design.

**PREVIEW:** Device has been announced but is not in production. Samples may or may not be available.

**OBSOLETE:** TI has discontinued the production of the device.

(2) **RoHS:** TI defines "RoHS" to mean semiconductor products that are compliant with the current EU RoHS requirements for all 10 RoHS substances, including the requirement that RoHS substance do not exceed 0.1% by weight in homogeneous materials. Where designed to be soldered at high temperatures, "RoHS" products are suitable for use in specified lead-free processes. TI may reference these types of products as "Pb-Free".

**RoHS Exempt:** TI defines "RoHS Exempt" to mean products that contain lead but are compliant with EU RoHS pursuant to a specific EU RoHS exemption.

**Green:** TI defines "Green" to mean the content of Chlorine (Cl) and Bromine (Br) based flame retardants meet JS709B low halogen requirements of <=1000ppm threshold. Antimony trioxide based flame retardants must also meet the <=1000ppm threshold requirement.

(3) MSL, Peak Temp. - The Moisture Sensitivity Level rating according to the JEDEC industry standard classifications, and peak solder temperature.

(4) There may be additional marking, which relates to the logo, the lot trace code information, or the environmental category on the device.

(5) Multiple Device Markings will be inside parentheses. Only one Device Marking contained in parentheses and separated by a "~" will appear on a device. If a line is indented then it is a continuation of the previous line and the two combined represent the entire Device Marking for that device.

(6) Lead/Ball Finish - Orderable Devices may have multiple material finish options. Finish options are separated by a vertical ruled line. Lead/Ball Finish values may wrap to two lines if the finish value exceeds the maximum column width.

**Important Information and Disclaimer:**The information provided on this page represents TI's knowledge and belief as of the date that it is provided. TI bases its knowledge and belief on information provided by third parties, and makes no representation or warranty as to the accuracy of such information. Efforts are underway to better integrate information from third parties. TI has taken and continues to take reasonable steps to provide representative and accurate information but may not have conducted destructive testing or chemical analysis on incoming materials and chemicals. TI and TI suppliers consider certain information to be proprietary, and thus CAS numbers and other limited information may not be available for release.

In no event shall TI's liability arising out of such information exceed the total purchase price of the TI part(s) at issue in this document sold by TI to Customer on an annual basis.



**TAPE AND REEL INFORMATION**

**QUADRANT ASSIGNMENTS FOR PIN 1 ORIENTATION IN TAPE**

\*All dimensions are nominal

Device	Package Type	Package Drawing	Pins	SPQ	Reel Diameter (mm)	Reel Width W1 (mm)	A0 (mm)	B0 (mm)	K0 (mm)	P1 (mm)	W (mm)	Pin1 Quadrant
TPS24720RGTR	VQFN	RGT	16	3000	330.0	12.4	3.3	3.3	1.1	8.0	12.0	Q2
TPS24720RGTR	VQFN	RGT	16	3000	330.0	12.4	3.3	3.3	1.1	8.0	12.0	Q2
TPS24720RGTT	VQFN	RGT	16	250	180.0	12.4	3.3	3.3	1.1	8.0	12.0	Q2
TPS24720RGTT	VQFN	RGT	16	250	180.0	12.5	3.3	3.3	1.1	8.0	12.0	Q2

**TAPE AND REEL BOX DIMENSIONS**

\*All dimensions are nominal

Device	Package Type	Package Drawing	Pins	SPQ	Length (mm)	Width (mm)	Height (mm)
TPS24720RGTR	VQFN	RGT	16	3000	367.0	367.0	35.0
TPS24720RGTR	VQFN	RGT	16	3000	338.0	355.0	50.0
TPS24720RGTT	VQFN	RGT	16	250	210.0	185.0	35.0
TPS24720RGTT	VQFN	RGT	16	250	205.0	200.0	33.0

**RGT 16**

**GENERIC PACKAGE VIEW**

**VQFN - 1 mm max height**

PLASTIC QUAD FLATPACK - NO LEAD



Images above are just a representation of the package family, actual package may vary.  
Refer to the product data sheet for package details.

4203495/1

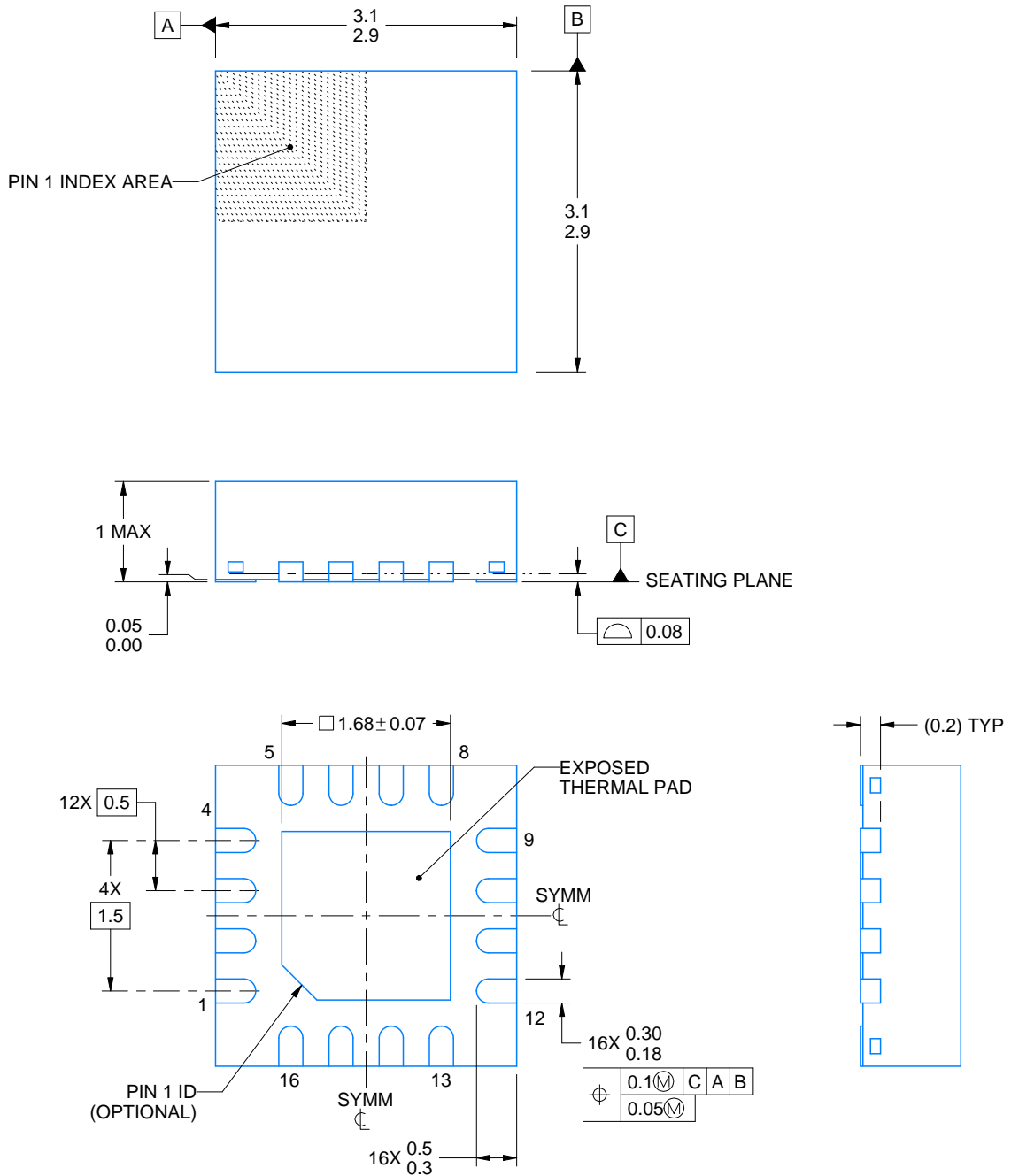
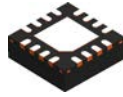

4222419/B 11/2016

NOTES:

1. All linear dimensions are in millimeters. Any dimensions in parenthesis are for reference only. Dimensioning and tolerancing per ASME Y14.5M.
2. This drawing is subject to change without notice.
3. The package thermal pad must be soldered to the printed circuit board for thermal and mechanical performance.

# EXAMPLE BOARD LAYOUT

RGT0016C

VQFN - 1 mm max height

PLASTIC QUAD FLATPACK - NO LEAD

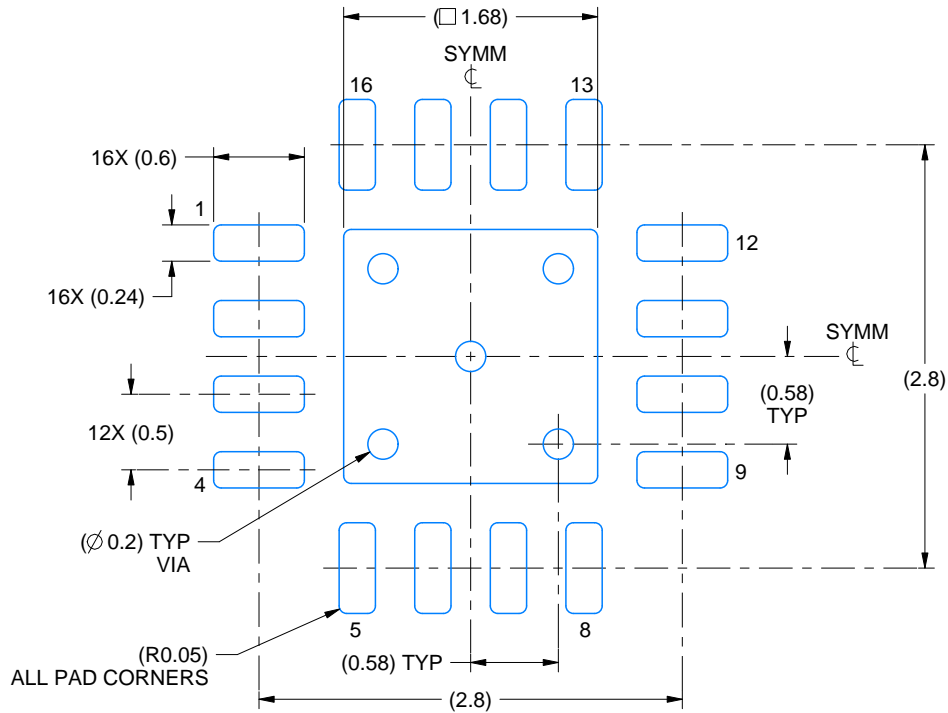

LAND PATTERN EXAMPLE  
SCALE:20X

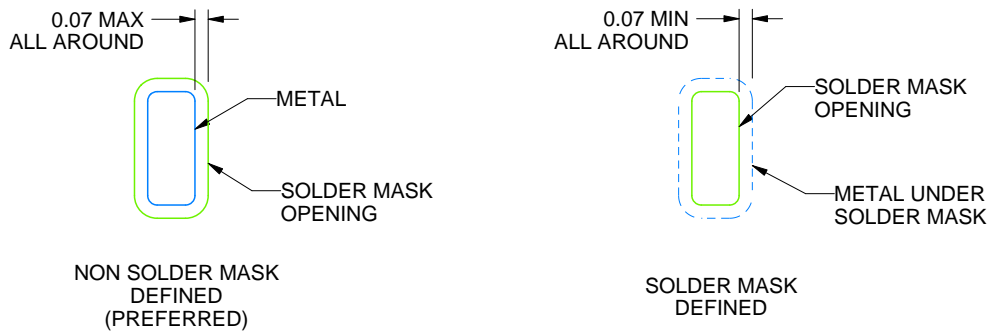

SOLDER MASK DETAILS

4222419/B 11/2016

NOTES: (continued)

- This package is designed to be soldered to a thermal pad on the board. For more information, see Texas Instruments literature number SLUA271 ([www.ti.com/lit/slua271](http://www.ti.com/lit/slua271)).
- Vias are optional depending on application, refer to device data sheet. If any vias are implemented, refer to their locations shown on this view. It is recommended that vias under paste be filled, plugged or tented.

# EXAMPLE STENCIL DESIGN

RGT0016C

VQFN - 1 mm max height

PLASTIC QUAD FLATPACK - NO LEAD

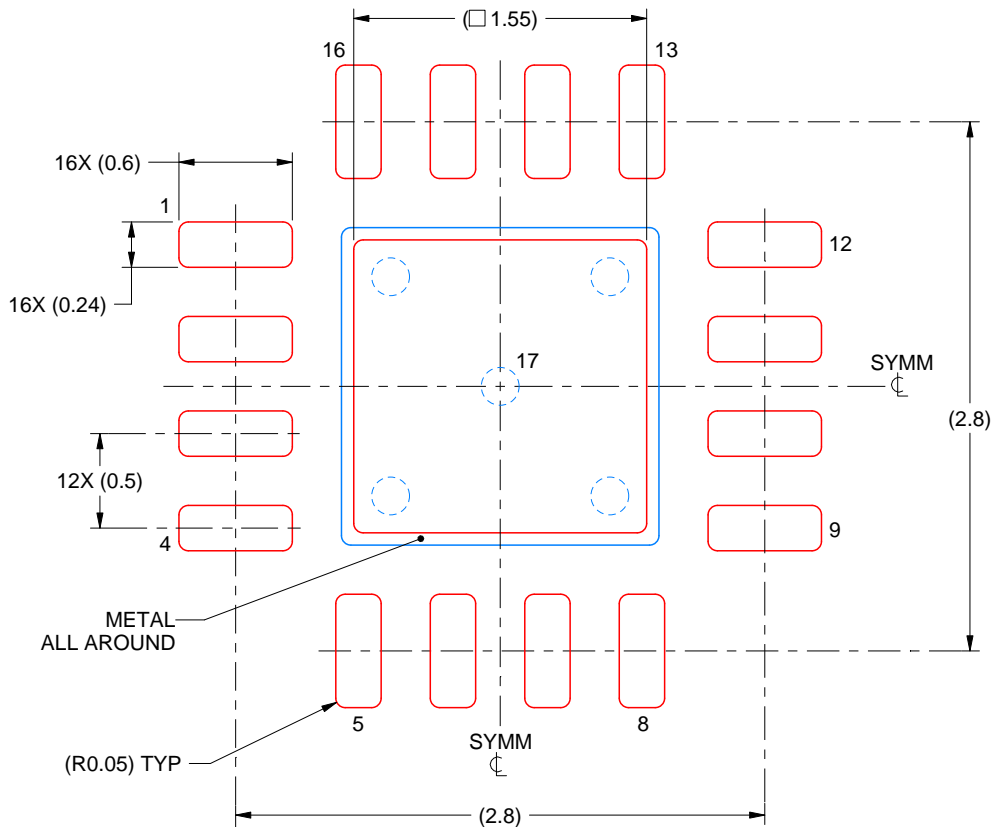

**SOLDER PASTE EXAMPLE**  
BASED ON 0.125 mm THICK STENCIL

EXPOSED PAD 17:  
85% PRINTED SOLDER COVERAGE BY AREA UNDER PACKAGE  
SCALE:25X

4222419/B 11/2016

NOTES: (continued)

6. Laser cutting apertures with trapezoidal walls and rounded corners may offer better paste release. IPC-7525 may have alternate design recommendations.



## IMPORTANT NOTICE AND DISCLAIMER

TI PROVIDES TECHNICAL AND RELIABILITY DATA (INCLUDING DATASHEETS), DESIGN RESOURCES (INCLUDING REFERENCE DESIGNS), APPLICATION OR OTHER DESIGN ADVICE, WEB TOOLS, SAFETY INFORMATION, AND OTHER RESOURCES "AS IS" AND WITH ALL FAULTS, AND DISCLAIMS ALL WARRANTIES, EXPRESS AND IMPLIED, INCLUDING WITHOUT LIMITATION ANY IMPLIED WARRANTIES OF MERCHANTABILITY, FITNESS FOR A PARTICULAR PURPOSE OR NON-INFRINGEMENT OF THIRD PARTY INTELLECTUAL PROPERTY RIGHTS.

These resources are intended for skilled developers designing with TI products. You are solely responsible for (1) selecting the appropriate TI products for your application, (2) designing, validating and testing your application, and (3) ensuring your application meets applicable standards, and any other safety, security, or other requirements. These resources are subject to change without notice. TI grants you permission to use these resources only for development of an application that uses the TI products described in the resource. Other reproduction and display of these resources is prohibited. No license is granted to any other TI intellectual property right or to any third party intellectual property right. TI disclaims responsibility for, and you will fully indemnify TI and its representatives against, any claims, damages, costs, losses, and liabilities arising out of your use of these resources.

TI's products are provided subject to TI's Terms of Sale ([www.ti.com/legal/termsofsale.html](http://www.ti.com/legal/termsofsale.html)) or other applicable terms available either on [ti.com](http://ti.com) or provided in conjunction with such TI products. TI's provision of these resources does not expand or otherwise alter TI's applicable warranties or warranty disclaimers for TI products.

Mailing Address: Texas Instruments, Post Office Box 655303, Dallas, Texas 75265  
Copyright © 2019, Texas Instruments Incorporated