

DESCRIPTION: R/A - 0.318 - MALE - ECONOMY - D SUB

25-PIN SHOWN

No. OF PINS	DIMENSIONS			
	A	B	C	D
009	1.213	0.984	0.666	0.492
	30.80	24.99	16.92	12.50
015	1.541	1.312	0.994	0.656
	39.14	33.32	25.25	16.66
025	2.088	1.852	1.534	0.926
	53.04	47.04	38.96	23.52
037	2.729	2.500	2.181	1.250
	69.32	63.50	57.30	31.75

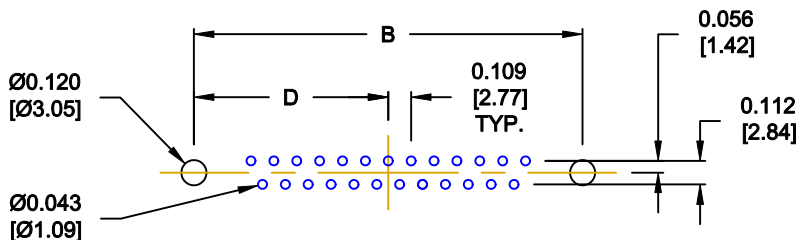
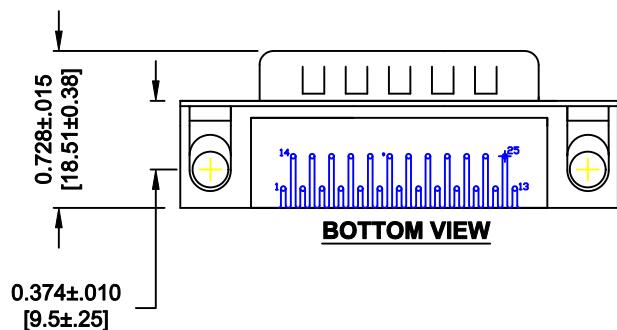
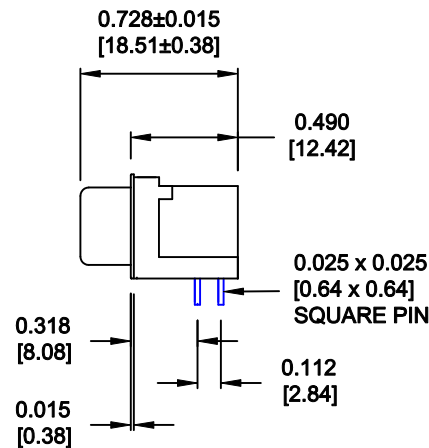
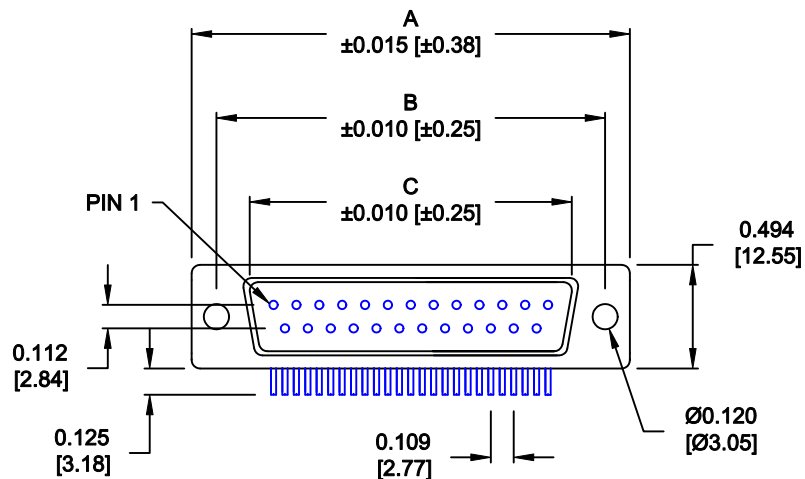

RECOMMENDED PCB LAYOUT

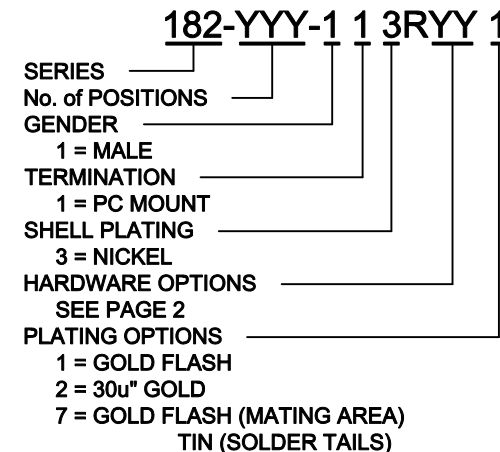

MATERIAL:

- SHELL: SPCC, NICKEL PLATED
- INSULATOR: UL 94V-O RATED, BLACK, 260° PA9T
- CONTACT: BRASS, GOLD PLATED
- RIVET: COPPER ALLOY, NICKEL PLATED
- SCREWLOCK: ZINC ALLOY, NICKEL PLATED
- BOARDLOCK: SPCC, TIN PLATED

ELECTRICAL:

- CURRENT RATING: 5 AMPS
- DIELECTRIC STRENGTH: 1,000VAC rms
- INSULATION RESISTANCE: 1,000 MOHMS Min
- TEMPERATURE: -55°C TO +105°C

GENERAL TOLERANCES

± 0.006 [0.15]
 HOLE : ± 0.005 [0.13]

DO NOT SCALE FROM DRAWING

RoHS COMPLIANT

	THESE DRAWINGS AND SPECIFICATIONS ARE THE PROPERTY OF NorComp AND SHALL NOT BE REPRODUCED, COPIED OR USED AS THE BASIS FOR THE MANUFACTURE OF SALE OF APPARATUS WITHOUT WRITTEN PERMISSION.		DRAWN: PAM JENKINS	DATE: 03-17-05
			CHECKED:	DATE:
<h1>NorComp</h1>		SCALE: 1 : 1	SHEET 1 OF 2	REV 9
		DWG NO. 182-YYY-113RYY1		

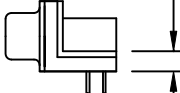
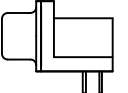
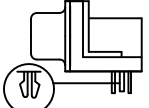
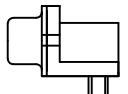
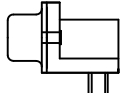
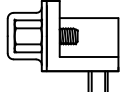
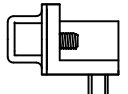
	 <p>0.141 ±0.020</p> <p>METAL SHELL WITH INSIDE GROUND STRAPS</p>	 <p>METAL SHELL</p>	 <p>METAL SHELL FORK BOARD LOCKS</p>
 <p>.120" DIA. HOLE</p>	16	43	55
 <p>4-40 FLUSH INSERT</p>	17	45	53 BOARD LOCKS IN HOLE
 <p>4-40 HEX STANDOFF FEMALE SCREWLOCK</p>	18	48	56 BOARD LOCKS IN HOLE
 <p>4-40 ROUND STANDOFF FEMALE SCREWLOCK</p>	N/A	N/A	N/A

DO NOT SCALE FROM DRAWING

	THESE DRAWINGS AND SPECIFICATIONS ARE THE PROPERTY OF NorComp AND SHALL NOT BE REPRODUCED, COPIED OR USED AS THE BASIS FOR THE MANUFACTURE OF SALE OF APPARATUS WITHOUT WRITTEN PERMISSION.		DRAWN: PAM JENKINS	DATE: 03-17-05
			CHECKED:	DATE:
NorComp		SCALE: 1 : 1	SHEET 2 OF 2	REV 9
		DWG NO. 182-YYY-113RYY1		

RoHS COMPLIANT

Mouser Electronics

Authorized Distributor

Click to View Pricing, Inventory, Delivery & Lifecycle Information:

NorComp:

[182-009-113R531](#) [182-015-113R531](#) [182-009-113R161](#) [182-009-113R171](#) [182-009-113R181](#) [182-015-113R161](#)
[182-015-113R171](#) [182-015-113R181](#) [182-025-113R161](#) [182-025-113R171](#) [182-025-113R181](#) [182-037-113R161](#)
[182-037-113R171](#) [182-037-113R181](#) [182-037-113R531](#) [182-025-113R531](#) [182-015-113R561](#) [182-009-113R561](#)
[182-025-113R561](#) [182-037-113R561](#) [182-037-212-531](#) [182-015-212-531](#) [182-025-112-531](#) [182-025-212-531](#) [182-](#)
[009-212-181](#) [182-037-112-531](#) [182-015-212-171](#) [182-015-112-531](#) [182-009-212-531](#) [182-009-112-531](#)