

# Features

# Switching Regulator

- Efficiency up to 96%, no heatsinks required
- Pin-out compatible with LM78XX linears
- Low profile (L/W/H=11.5 x 8.5 x 17.5mm)
- High input voltage range, up to 72V
- Short circuit protection, thermal shutdown
- Low ripple and noise
- „L“ version with 90° pins
- Positive to negative converter



## R-78HB-0.5(L)

0.5 Amp  
SIP3  
Single Output



### Description

The R-78HBxx-Series high efficiency, high input voltage switching regulators are ideally suited to replace 78xx linear regulators and are pin compatible. The efficiency of up to 96% means that very little energy is wasted as heat so there is no need for any heat sinks with their additional space and mounting costs.

An input voltage range of up to 8:1 is unsurpassed by any other converter and allows the full stored energy utilization of standard and high voltage batteries. The fully protected output is ideal for industrial applications (especially for industry standard 24VDC bus supplies) and the L-Version with 90° pins allows direct replacement for laid-flat regulators where component height is at a premium. Low ripple and noise figures and a short circuit input current of typically only 15mA round off the specifications of this versatile converter series. Typical applications include telecommunication, automotive, industrial, aerospace and battery powered applications.



### Selection Guide

Part Number	Input Voltage Range [VDC]	Output Voltage [VDC]	Output Current [A]	Efficiency	
				@ min Vin [%]	@ max. Vin [%]
R-78HB3.3-0.5	9 - 72	3.3	0.5	82	76
R-78HB5.0-0.5	9 - 72	5.0	0.5	87	81
R-78HB6.5-0.5	9 - 72	6.5	0.5	91	84
R-78HB9.0-0.5	14 - 72	9.0	0.5	92	86
R-78HB12-0.5	17 - 72	12	0.5	94	89
R-78HB15-0.5	20 - 72	15	0.5	95	91
R-78HB24-0.3	36 - 72	24	0.3	96	92

### Model Numbering

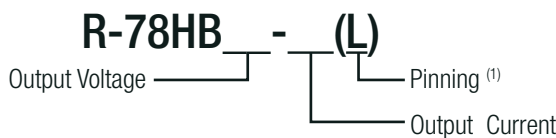

**Notes:**

Note1: add suffix „L“ for 90° bent pins, e.g. R-78B5.0-1.0L



IEC/EN60950-1 certified  
EN55032 compliant

### Specifications (measured @ Ta= 25°C, 10% minimum load, unless otherwise stated)

BASIC CHARACTERISTICS				
Parameter	Condition	Min.	Typ.	Max.
Internal Input Filter				1µF capacitor
Absolute Maximum Input Voltage				75VDC
Quiescent Current	nom. Vin= 48VDC		1mA	5mA
Internal Power Dissipation				0.65W
Minimum Load (2)		2%		
<p><b>Notes:</b></p> <p>Note2: Operation under no load will not harm the converter, but specifications may not be met A minimum load of 10mA is recommended</p> <p style="text-align: center;">continued on next page</p>				

**Specifications** (measured @ Ta= 25°C, 10% minimum load, unless otherwise stated)

Parameter	Condition	Min.	Typ.	Max.
Internal Operating Frequency	nom. Vin= 48VDC	120kHz		800kHz
Output Ripple and Noise	20MHz BW (10 - 100% load)		20mVp-p	60mVp-p
Absolute Maximum Capacitive Load	1 second start up, no external components <1 second start up + diode protection circuit			100µF 6800µF

### Switching Frequency vs. Load

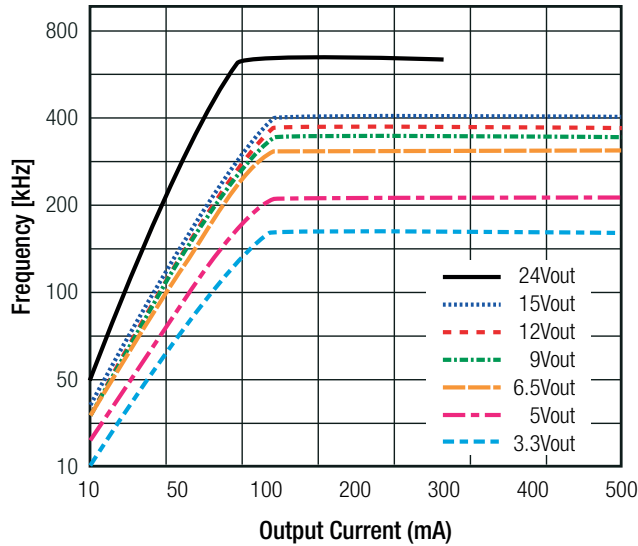

### Efficiency vs. Vin (full load)

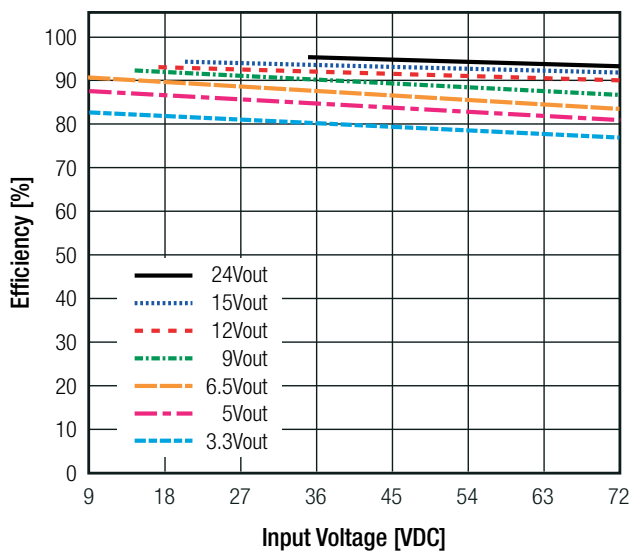

### Ripple vs. Vin (full load)

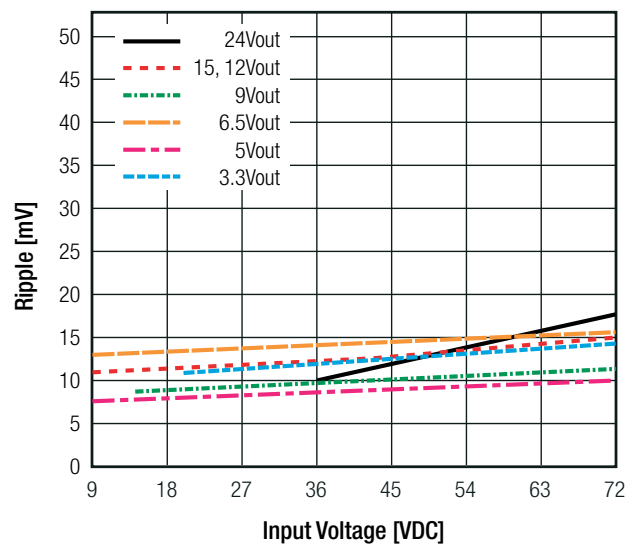

continued on next page

Specifications (measured @ Ta= 25°C, 10% minimum load, unless otherwise stated)

Efficiency vs. Load (max. Vin)

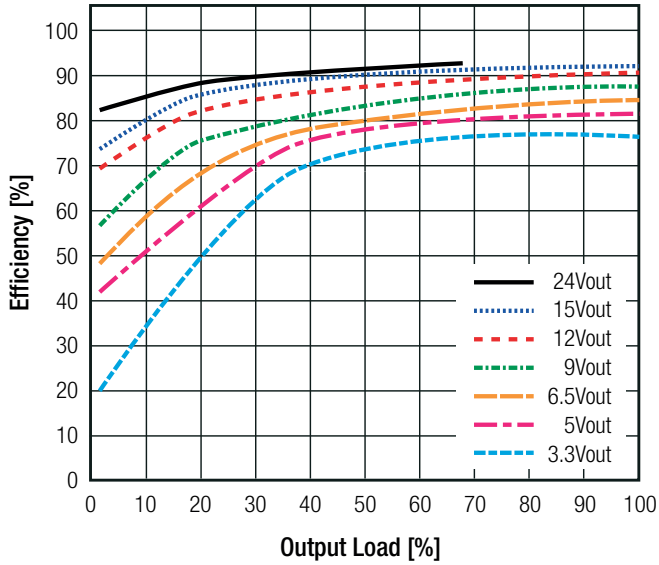

Ripple vs. Load (max. Vin)

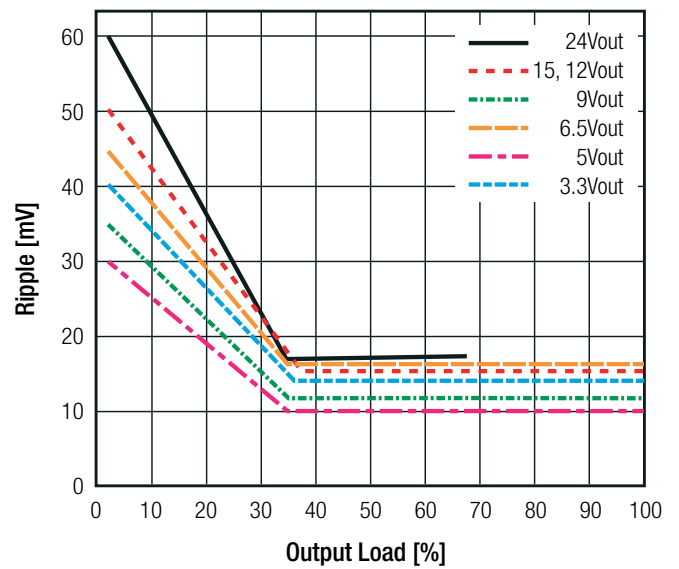

Efficiency vs. Load (min. Vin)

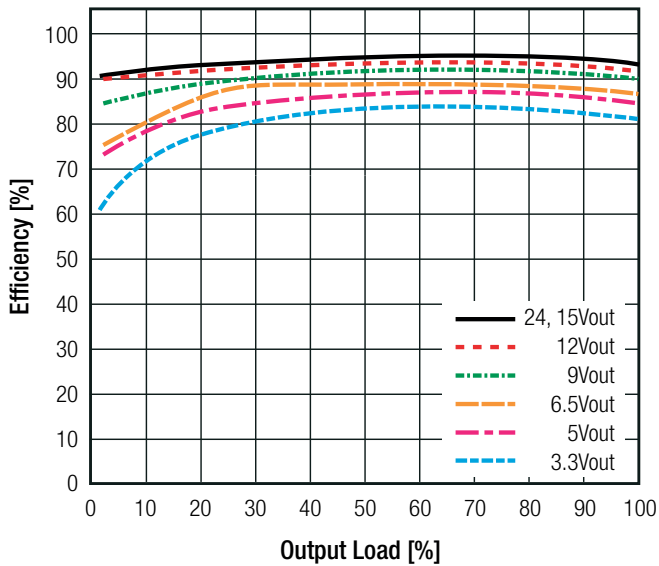

Ripple vs. Load (min. Vin)

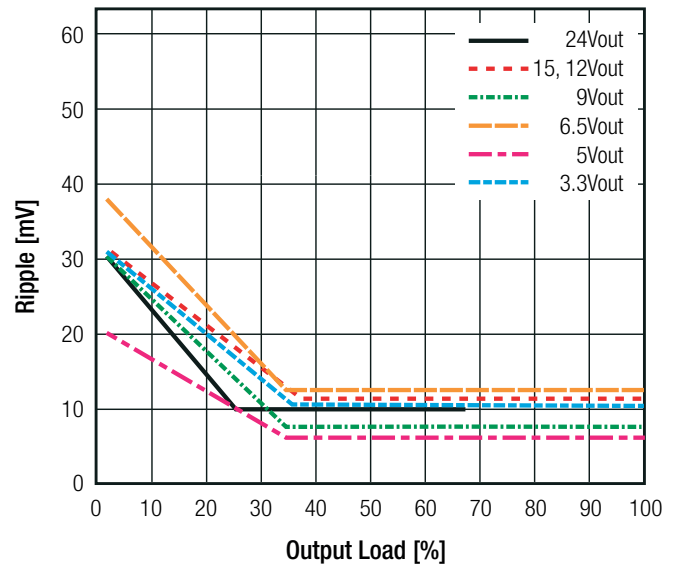

**REGULATIONS**

Parameter	Condition	Value
Output Accuracy	100% load	±2.0% typ / ±3.0% max.
Line Regulation	low line to high line, 100% load	±0.4% typ. / ±1.0% max.
Load Regulation	10% to 100% load	±0.3% typ. / ±0.6% max.
Transient Response <sup>(3)</sup>	100% <-> 50% load	±75mV typ. / ±100mV max.

**Notes:**

Note3: Measurements are made with a 100µF output capacitor

**Specifications** (measured @ Ta= 25°C, 10% minimum load, unless otherwise stated)

### PROTECTIONS

Parameter	Condition	Value
Short Circuit Protection (SCP)	below 100mΩ	continuous, automatic recovery
Short Circuit Input Current	nom. Vin= 24VDC	15mA typ. / 25mA max.

### Optional Diode Protection Circuit

Add a blocking diode to Vout if current can flow backwards into the output, as this can damage the converter when it is powered down.

The diode can either be fitted across the device if the source is low impedance or fitted in series with the output (recommended).

#### Optional Protection 1:

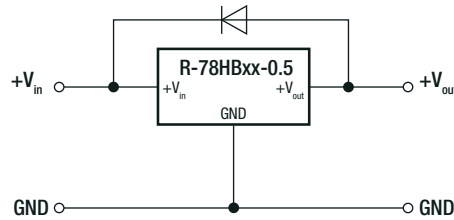

#### Optional Protection 2:

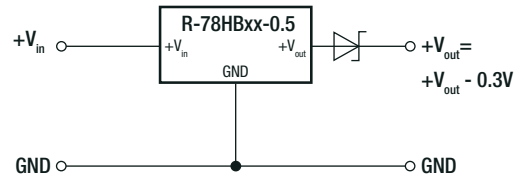

### Protection Circuit

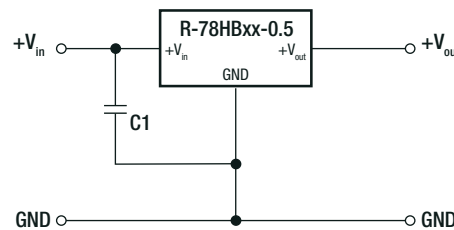

To protect the converter during power-up, use C1=3.3µF/100V if Vin>50V

### ENVIRONMENTAL

Parameter	Condition	Value
Operating Temperature Range	with derating (see graph)	-40°C to +85°C
Maximum Case Temperature		+100°C
Temperature Coefficient		±0.015%/K
Thermal Impedance	0.1 m/s, vertical	60K/W
Operating Altitude		2000m
Operating Humidity	non-condensing	95% RH max.
Pollution Degree		PD2
MTBF	according to MIL-HDBK-217F, G.B.	+25°C: 7395 x 10 <sup>3</sup> hours +71°C: 1242 x 10 <sup>3</sup> hours

### Derating Graph

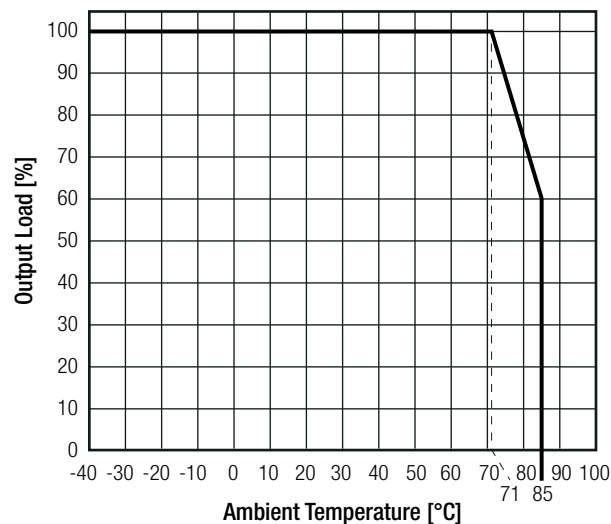

**Specifications** (measured @ Ta= 25°C, 10% minimum load, unless otherwise stated)

### SAFETY AND CERTIFICATIONS

Certificate Type (Safety)	Report / File Number	Standard
Information Technology Equipment, General Requirements for Safety	1603123	IEC60950-1:2005, 2nd Edition + AM 2:2013 EN60950-1:2006 + AM 2:2013
EAC	RU-AT.49.09571	TP TC 004/2011
RoHs 2+		RoHS 2011/65/EU + AM2015/863

EMC Compliance	Condition	Standard / Criterion
Electromagnetic compatibility of multimedia equipment - Emission requirements	with external components	EN55032, Class A EN55032, Class B
ESD Electrostatic discharge immunity test	Air ±8kV, Contact ±4kV	EN61000-4-2, Criteria A
Radiated, radio-frequency, electromagnetic field immunity test	3V/m	EN61000-4-3, Criteria A

### DIMENSION AND PHYSICAL CHARACTERISTICS

Parameter	Type	Value
Material	case potting	non-conductive black plastic, (UL94 V-0) silicone, (UL94 V-0)
Package Dimension (LxWxH)		11.5 x 8.5 x 17.5mm
Package Weight		4g typ.

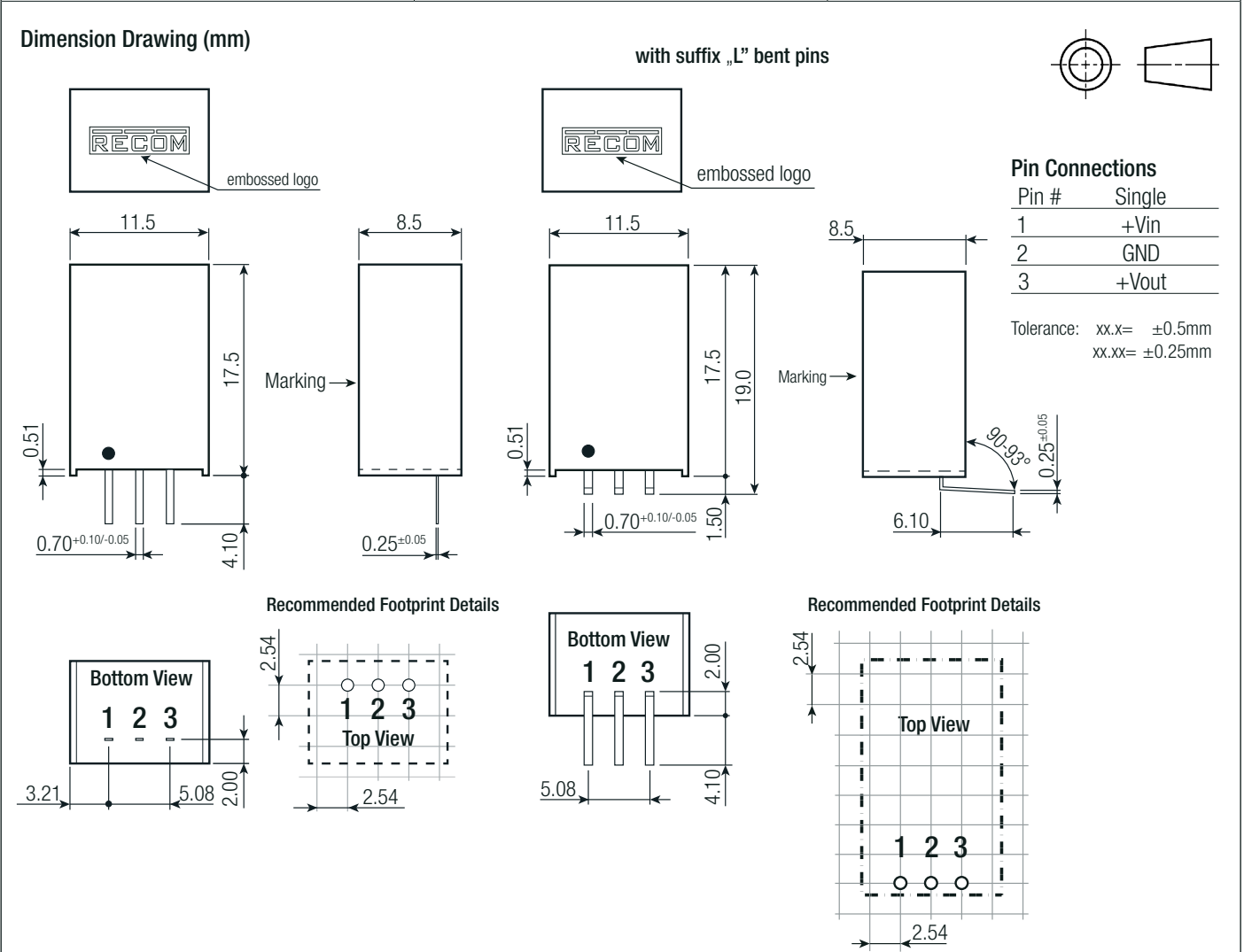

**Specifications** (measured @ Ta= 25°C, 10% minimum load, unless otherwise stated)

## INSTALLATION AND APPLICATION

### Positive to Negative Converter

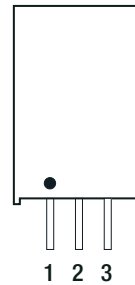
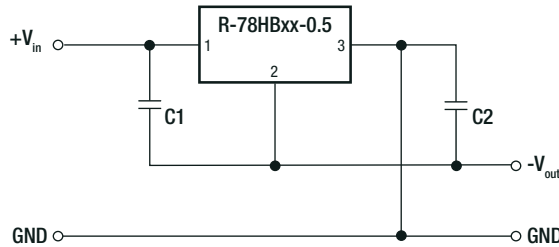

C1 and C2 are required and should be fitted close to the converter pins.

Maximum capacitive load including C2 is 100µF

#### Pin Connections

Pin #	Negative	Positive
1	+Vin	+Vin
2	-Vout	GND
3	GND	+Vout

### Selection Guide - Negative Output

Part Number	Input Voltage Range [VDC]	Output Voltage [VDC]	Output Current [A]	Efficiency		External Capacitor	
				@ min Vin [%]	@ max. Vin [%]	C1	C2 <sup>(4)</sup>
R-78HB3.3-0.5	15 - 65	-3.3	-0.4	78	75	1µF/100V	22µF/6.3V
R-78HB5.0-0.5	15 - 65	-5.0	-0.4	82	80	1µF/100V	22µF/10V
R-78HB6.5-0.5	15 - 65	-6.5	-0.3	84	82	1µF/100V	10µF/10V
R-78HB9.0-0.5	15 - 62	-9.0	-0.2	87	85	1µF/100V	10µF/16V
R-78HB12-0.5	15 - 59	-12	-0.2	88	86	1µF/100V	10µF/25V
R-78HB15-0.5	15 - 56	-15	-0.2	89	87	1µF/100V	10µF/25V
R-78HB24-0.3	15 - 48	-24	-0.2	89	87	1µF/100V	10µF/35V

#### Notes:

Note4: Maximum Capacitive Load including C2 is 100µF

### Dual Output (two Converters) with Negative Output

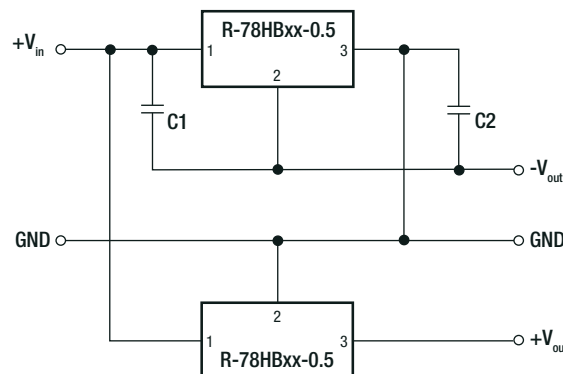

continued on next page

**Specifications** (measured @ Ta= 25°C, 10% minimum load, unless otherwise stated)

### High Input Voltage Multiple Output Supply

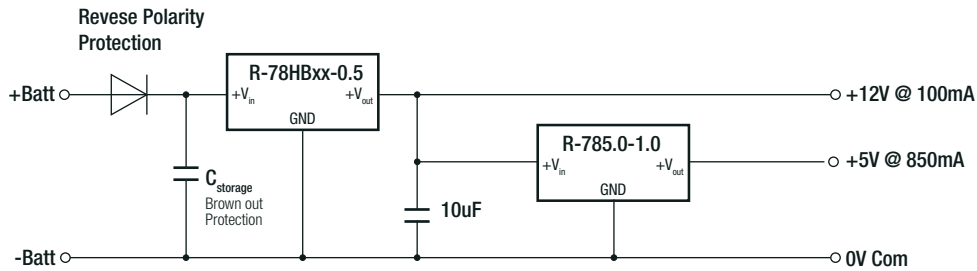

- Wide input range 18V to 72V - can be used with 24V, 48V or 60V batteries
- +12V outputs for interface and display electronics
- +5V high current output for digital electronics
- Further decoupling filtering may be necessary between the converters

### PACKAGING INFORMATION

Parameter	Type		Value
Packaging Dimension (LxWxH)	tube	without suffix	520.0 x 25.1 x 10.6mm
		with suffix "L"	520.0 x 26.1 x 15.8mm
Packaging Quantity	tube		42pcs
Storage Temperature Range			-55°C to +125°C
Storage Humidity			95% RH max.

The product information and specifications may be subject to changes even without prior written notice. The product has been designed for various applications; its suitability lies in the responsibility of each customer. The products are not authorized for use in safety-critical applications without RECOM's explicit written consent. A safety-critical application is an application where a failure may reasonably be expected to endanger or cause loss of life, inflict bodily harm or damage property. The applicant shall indemnify and hold harmless RECOM, its affiliated companies and its representatives against any damage claims in connection with the unauthorized use of RECOM products in such safety-critical applications.

# Mouser Electronics

Authorized Distributor

Click to View Pricing, Inventory, Delivery & Lifecycle Information:

## RECOM:

[R-78HB24-0.3](#) [R-78HB3.3-0.5](#) [R-78HB5.0-0.5](#) [R-78HB12-0.5](#) [R-78HB12-0.5L](#) [R-78HB15-0.5](#) [R-78HB15-0.5L](#) [R-78HB24-0.3L](#) [R-78HB3.3-0.5L](#) [R-78HB5.0-0.5L](#) [R-78HB6.5-0.5](#) [R-78HB6.5-0.5L](#) [R-78HB9.0-0.5](#) [R-78HB9.0-0.5L](#)