

# Type 381LX / 383LX 105 °C High Ripple, Snap-In Aluminum

High Ripple, Long Life, 2, 4 and 5 pin styles available



Adding longer-life and more ripple capability to the excellent value of Type 380L/LX capacitors, the 381L/LX readily handles tough switching power supply input and output circuits and motor-drive bus capacitor applications where the high surface area of multiple units in parallel equals the ripple capability of our Type 520C inverter-grade capacitor. Type 381LX delivers more capacitance per can size while Type 381L gives lower ESR for the same capacitance rating. Type 383L/LX has 4 or 5 leads for stable, reverse-proof mounting.

## Highlights

- Top performance in power supplies and motor drives
- 4 times the life of Type 380L/LX
- 2, 4 and 5 leads available
- Big selection of 42 case sizes

## Specifications

| Temperature Range               | -40 °C to + 105 °C ≤ 250 Vdc<br>-25 °C to + 105 °C ≥ 315 Vdc  |       |        |        |        |            |        |                            |      |      |      |      |      |                                |      |      |      |      |      |  |       |       |        |        |       |            |                   |      |      |      |      |      |      |                    |      |      |      |      |      |      |
|---------------------------------|---|-------|--------|--------|--------|------------|--------|----------------------------|------|------|------|------|------|--------------------------------|------|------|------|------|------|--|-------|-------|--------|--------|-------|------------|-------------------|------|------|------|------|------|------|--------------------|------|------|------|------|------|------|
| Rated Voltage Range             | 10 Vdc to 450 Vdc   |       |        |        |        |            |        |                            |      |      |      |      |      |                                |      |      |      |      |      |  |       |       |        |        |       |            |                   |      |      |      |      |      |      |                    |      |      |      |      |      |      |
| Capacitance Range               | 33 µF to 150,000 µF   |       |        |        |        |            |        |                            |      |      |      |      |      |                                |      |      |      |      |      |  |       |       |        |        |       |            |                   |      |      |      |      |      |      |                    |      |      |      |      |      |      |
| Capacitance Tolerance           | ± 20%   |       |        |        |        |            |        |                            |      |      |      |      |      |                                |      |      |      |      |      |  |       |       |        |        |       |            |                   |      |      |      |      |      |      |                    |      |      |      |      |      |      |
| Leakage Current                 | ≤ 3 $\sqrt{CV}$ µA, 4 mA max, 5 minutes   |       |        |        |        |            |        |                            |      |      |      |      |      |                                |      |      |      |      |      |  |       |       |        |        |       |            |                   |      |      |      |      |      |      |                    |      |      |      |      |      |      |
| Ripple Current Multipliers      | <p>Ambient Temperature</p> <table border="1"> <thead> <tr> <th></th> <th>45 °C</th> <th>60 °C</th> <th>70 °C</th> <th>85 °C</th> <th>105 °C</th> </tr> </thead> <tbody> <tr> <td><b>381L</b><br/><b>383L</b></td> <td>2.70</td> <td>2.60</td> <td>2.50</td> <td>2.10</td> <td>1.00</td> </tr> <tr> <td><b>381LX,</b><br/><b>383 LX</b></td> <td>2.35</td> <td>2.20</td> <td>2.00</td> <td>1.70</td> <td>1.00</td> </tr> </tbody> </table> <p>Frequency</p> <table border="1"> <thead> <tr> <th></th> <th>50 Hz</th> <th>60 Hz</th> <th>120 Hz</th> <th>500 Hz</th> <th>1 kHz</th> <th>5 kHz &amp; up</th> </tr> </thead> <tbody> <tr> <td><b>10-100 Vdc</b></td> <td>0.93</td> <td>0.95</td> <td>1.00</td> <td>1.05</td> <td>1.08</td> <td>1.15</td> </tr> <tr> <td><b>160-450 Vdc</b></td> <td>0.75</td> <td>0.80</td> <td>1.00</td> <td>1.20</td> <td>1.25</td> <td>1.40</td> </tr> </tbody> </table> |       | 45 °C  | 60 °C  | 70 °C  | 85 °C      | 105 °C | <b>381L</b><br><b>383L</b> | 2.70 | 2.60 | 2.50 | 2.10 | 1.00 | <b>381LX,</b><br><b>383 LX</b> | 2.35 | 2.20 | 2.00 | 1.70 | 1.00 |  | 50 Hz | 60 Hz | 120 Hz | 500 Hz | 1 kHz | 5 kHz & up | <b>10-100 Vdc</b> | 0.93 | 0.95 | 1.00 | 1.05 | 1.08 | 1.15 | <b>160-450 Vdc</b> | 0.75 | 0.80 | 1.00 | 1.20 | 1.25 | 1.40 |
|                                 | 45 °C   | 60 °C | 70 °C  | 85 °C  | 105 °C |            |        |                            |      |      |      |      |      |                                |      |      |      |      |      |  |       |       |        |        |       |            |                   |      |      |      |      |      |      |                    |      |      |      |      |      |      |
| <b>381L</b><br><b>383L</b>      | 2.70  | 2.60  | 2.50   | 2.10   | 1.00   |            |        |                            |      |      |      |      |      |                                |      |      |      |      |      |  |       |       |        |        |       |            |                   |      |      |      |      |      |      |                    |      |      |      |      |      |      |
| <b>381LX,</b><br><b>383 LX</b>  | 2.35  | 2.20  | 2.00   | 1.70   | 1.00   |            |        |                            |      |      |      |      |      |                                |      |      |      |      |      |  |       |       |        |        |       |            |                   |      |      |      |      |      |      |                    |      |      |      |      |      |      |
|                                 | 50 Hz   | 60 Hz | 120 Hz | 500 Hz | 1 kHz  | 5 kHz & up |        |                            |      |      |      |      |      |                                |      |      |      |      |      |  |       |       |        |        |       |            |                   |      |      |      |      |      |      |                    |      |      |      |      |      |      |
| <b>10-100 Vdc</b>               | 0.93  | 0.95  | 1.00   | 1.05   | 1.08   | 1.15       |        |                            |      |      |      |      |      |                                |      |      |      |      |      |  |       |       |        |        |       |            |                   |      |      |      |      |      |      |                    |      |      |      |      |      |      |
| <b>160-450 Vdc</b>              | 0.75  | 0.80  | 1.00   | 1.20   | 1.25   | 1.40       |        |                            |      |      |      |      |      |                                |      |      |      |      |      |  |       |       |        |        |       |            |                   |      |      |      |      |      |      |                    |      |      |      |      |      |      |
| Low Temperature Characteristics | Impedance ratio: $Z_{-20^{\circ}\text{C}}/Z_{+25^{\circ}\text{C}}$<br>≤ 10 (10 Vdc)<br>≤ 8 (16–50 Vdc)<br>≤ 4 (63–100 Vdc)<br>≤ 3 (150–450 Vdc)   |       |        |        |        |            |        |                            |      |      |      |      |      |                                |      |      |      |      |      |  |       |       |        |        |       |            |                   |      |      |      |      |      |      |                    |      |      |      |      |      |      |
| Endurance Life Test             | 3000 h at full load at 105 °C<br>Δ Capacitance ±20%<br>ESR 200% of limit<br>DCL 100% of limit   |       |        |        |        |            |        |                            |      |      |      |      |      |                                |      |      |      |      |      |  |       |       |        |        |       |            |                   |      |      |      |      |      |      |                    |      |      |      |      |      |      |
| Shelf Life Test                 | 1000 h at 105 °C<br>Δ Capacitance ±20%<br>ESR 200% of limit<br>DCL 100% of limit  |       |        |        |        |            |        |                            |      |      |      |      |      |                                |      |      |      |      |      |  |       |       |        |        |       |            |                   |      |      |      |      |      |      |                    |      |      |      |      |      |      |
| Vibration                       | 10 to 55 Hz, 0.06" and 10 g max, 2 h each plane   |       |        |        |        |            |        |                            |      |      |      |      |      |                                |      |      |      |      |      |  |       |       |        |        |       |            |                   |      |      |      |      |      |      |                    |      |      |      |      |      |      |
| <a href="#">RoHS Compliant</a>  |   |       |        |        |        |            |        |                            |      |      |      |      |      |                                |      |      |      |      |      |  |       |       |        |        |       |            |                   |      |      |      |      |      |      |                    |      |      |      |      |      |      |

# Type 381LX / 383LX 105 °C High Ripple, Snap-In Aluminum

High Ripple, Long Life, 2,4 and 5 pin styles available

|                         |               |                  |                |                  |                          |   |
|-------------------------|---------------|------------------|----------------|------------------|--------------------------|---|
| <b>383LX</b>            | <b>272</b>    | <b>M</b>         | <b>200</b>     | <b>N08</b>       | <b>2</b>                 | <b>V</b>                                |
|                         |               |                  |                |                  |                          |   |
| <b>Type</b>             | <b>Cap</b>    | <b>Tolerance</b> | <b>Voltage</b> | <b>Case Code</b> | <b>Insulation</b>        | <b># of pins</b>                        |
| 381L / LX (2 pins)      | 100 = 10 µF   | M = ±20%         | 200 = 200 Vdc  |                  | 2 = PVC                  | Blank = 2 pins / 4 pins snap-in 6.3mm L |
| 383L / LX (4 or 5 pins) | 101 = 100 µF  |                  |                |                  | or PET (PET after 12/19) | A = 2 pins / 4 pins snap-in 4.0mm L     |
|                         | 272 = 2700 µF |                  |                |                  |                          | VS = 5 pins snap-in 6.3mm L             |
|                         |               |                  |                |                  |                          | V = 5 pins standoff                     |

## Outline Drawings

Dimensions shown are in mm

Sleeving is PVC or PET (PET for all date codes after December 2019)

### Two Pins

381L/LX (22 through 40 mm diameter)

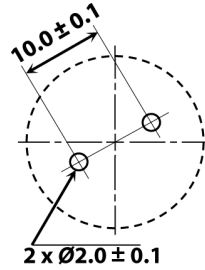
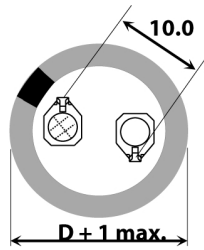
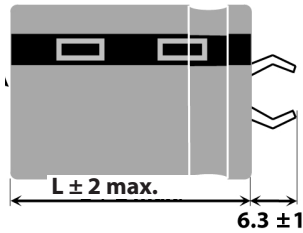

PC Board Mounting Holes

Available in 2, 4 and 5 pins

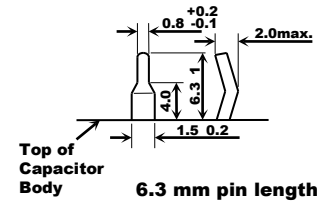

6.3 mm pin length

### Four Pins

383L/LX (35 and 40 mm diameter)

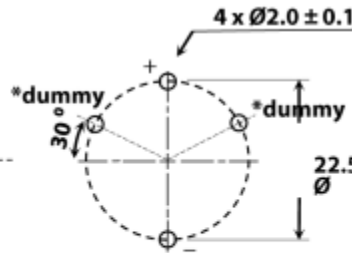
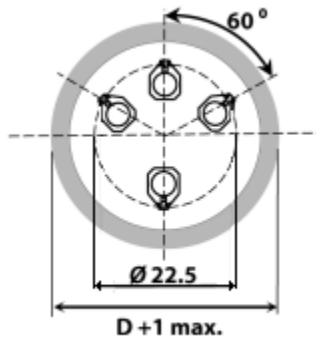
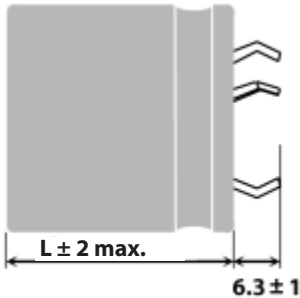

PC Board Mounting Holes

Available in 2 and 4 pins

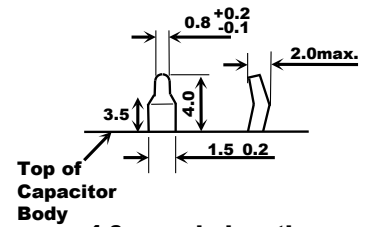

4.0 mm pin length option (add "A" to end of part#)

### Five Pins

383L/LX (40 and 50 mm diameter)

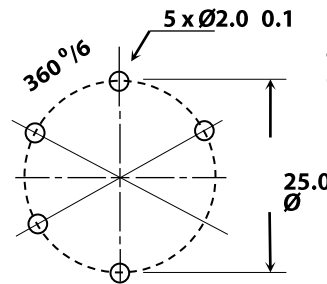
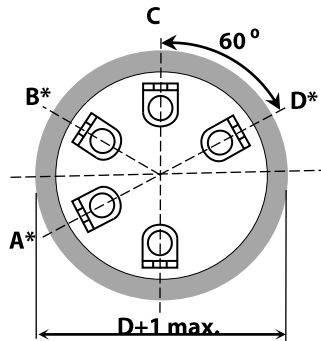
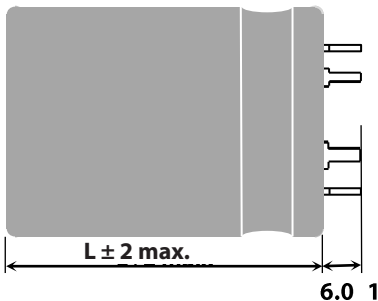

PC Board Mounting Holes

Available in 5 pins

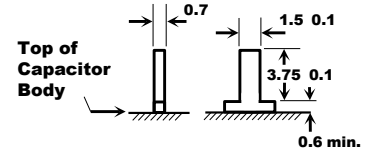

5 pin Standoff pin style (add "V" to end of part#)

| Terminal | Connection   |              |
|----------|--------------|--------------|
|          | 40 mm Dia.   | 50 mm Dia.   |
| A        | dummy        | negative (-) |
| B        | dummy        | dummy        |
| C        | positive (+) | positive (+) |
| D        | dummy        | positive (+) |
| -        | negative (-) | negative (-) |

Notes:

\* Use dummy terminals for mechanical support only. Make no electrical connection because they resistively connect through the electrolyte to the negative terminal.

\*\* Safety Vent may be on the bottom or on the side of the can.

# Type 381LX / 383LX 105 °C High Ripple, Snap-In Aluminum

High Ripple, Long Life, 2,4 and 5 pin styles available

## Insulated Case Dimensions

| Case Code | DIAMETER "D" |        | LENGTH "L" |        | Typical Weight (grams) |
|-----------|--------------|--------|------------|--------|------------------------|
|           | mm           | inches | mm         | inches |                        |
| H20       | 22           | 0.87   | 20         | 0.79   | 14                     |
| H01       | 22           | 0.87   | 25         | 0.98   | 16                     |
| H02       | 22           | 0.87   | 30         | 1.18   | 19                     |
| H03       | 22           | 0.87   | 35         | 1.38   | 22                     |
| H04       | 22           | 0.87   | 40         | 1.57   | 24                     |
| H45       | 22           | 0.87   | 45         | 1.77   | 28                     |
| H05       | 22           | 0.87   | 50         | 1.97   | 31                     |
| J20       | 25           | 0.98   | 20         | 0.79   | 16                     |
| J01       | 25           | 0.98   | 25         | 0.98   | 20                     |
| J02       | 25           | 0.98   | 30         | 1.18   | 24                     |
| J03       | 25           | 0.98   | 35         | 1.38   | 27                     |
| J04       | 25           | 0.98   | 40         | 1.57   | 31                     |
| J45       | 25           | 0.98   | 45         | 1.77   | 35                     |
| J05       | 25           | 0.98   | 50         | 1.97   | 38                     |
| K20       | 30           | 1.18   | 20         | 0.79   | 25                     |
| K01       | 30           | 1.18   | 25         | 0.98   | 30                     |
| K02       | 30           | 1.18   | 30         | 1.18   | 35                     |
| K03       | 30           | 1.18   | 35         | 1.38   | 40                     |
| K04       | 30           | 1.18   | 40         | 1.57   | 44                     |
| K45       | 30           | 1.18   | 45         | 1.77   | 48                     |
| K05       | 30           | 1.18   | 50         | 1.97   | 53                     |
| A20       | 35           | 1.38   | 20         | 0.79   | 35                     |
| A01       | 35           | 1.38   | 25         | 0.98   | 42                     |
| A02       | 35           | 1.38   | 30         | 1.18   | 48                     |
| A03       | 35           | 1.38   | 35         | 1.38   | 54                     |

| Case Code | DIAMETER "D" |        | LENGTH "L" |        | Typical Weight (grams) |
|-----------|--------------|--------|------------|--------|------------------------|
|           | mm           | inches | mm         | inches |                        |
| A04       | 35           | 1.38   | 40         | 1.57   | 62                     |
| A45       | 35           | 1.38   | 45         | 1.77   | 67                     |
| A05       | 35           | 1.38   | 50         | 1.97   | 74                     |
| A55       | 35           | 1.38   | 55         | 2.17   | 80                     |
| A06       | 35           | 1.38   | 63         | 2.48   | 88                     |
| A07       | 35           | 1.38   | 70         | 2.76   | 98                     |
| A08       | 35           | 1.38   | 80         | 3.15   | 112                    |
| A10       | 35           | 1.38   | 105        | 4.13   | 144                    |
| N04       | 40           | 1.57   | 40         | 1.57   | 82                     |
| N05       | 40           | 1.57   | 50         | 1.97   | 105                    |
| N06       | 40           | 1.57   | 63         | 2.48   | 130                    |
| N08       | 40           | 1.57   | 80         | 3.15   | 185                    |
| N10       | 40           | 1.57   | 105        | 4.13   | 265                    |
| E05       | 45           | 1.77   | 50         | 1.97   | 122                    |
| E06       | 45           | 1.77   | 63         | 2.48   | 150                    |
| E75       | 45           | 1.77   | 75         | 2.65   | 200                    |
| E08       | 45           | 1.77   | 80         | 3.15   | 213                    |
| E09       | 45           | 1.77   | 92         | 3.62   | 238                    |
| E10       | 45           | 1.77   | 105        | 4.13   | 299                    |
| B05       | 50           | 1.97   | 50         | 1.97   | 136                    |
| B06       | 50           | 1.97   | 63         | 2.48   | 168                    |
| B08       | 50           | 1.97   | 80         | 3.15   | 239                    |
| B09       | 50           | 1.97   | 92         | 3.62   | 241                    |
| B10       | 50           | 1.97   | 105        | 4.13   | 325                    |

## Typical Performance Curves

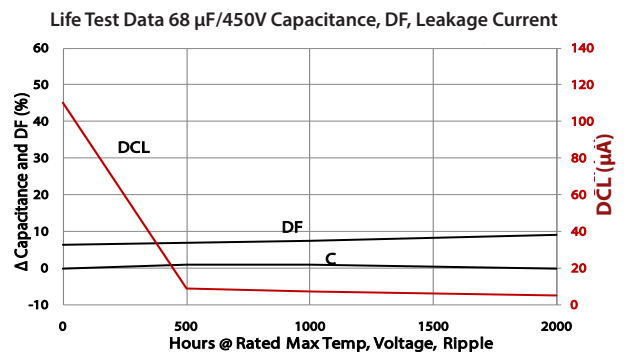
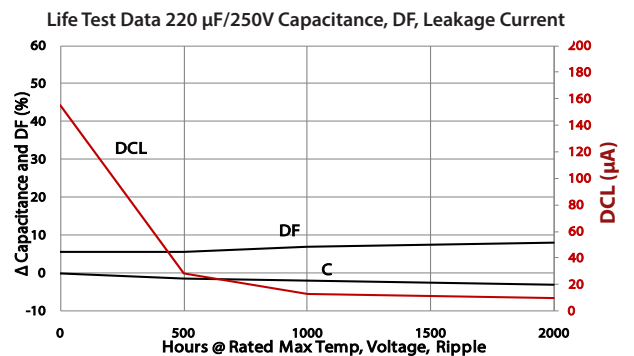
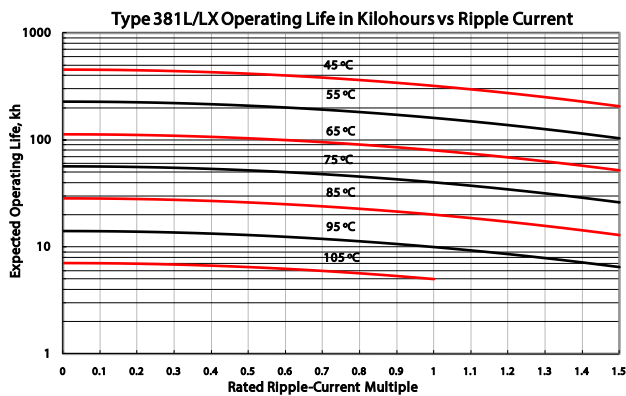

# Type 381LX / 383LX 105 °C High Ripple, Snap-In Aluminum

High Ripple, Long Life, 2,4 and 5 pin styles available

## Ratings

| Cap.<br>(µF)                 | Catalog<br>Part Number | Max. ESR<br>@ +25°C |                  | Ripple Amps<br>@ +105°C |               | Nominal<br>Size<br>D x L<br>(mm) | Cap.<br>(µF)                 | Catalog<br>Part Number | Max. ESR<br>@ +25°C |                  | Ripple Amps<br>@ +105°C |               | Nominal<br>Size<br>D x L<br>(mm) |
|------------------------------|------------------------|---------------------|------------------|-------------------------|---------------|----------------------------------|------------------------------|------------------------|---------------------|------------------|-------------------------|---------------|----------------------------------|
|                              |                        | 120 Hz<br>(ohms)    | 20 kHz<br>(ohms) | 120 Hz<br>(A)           | 20 kHz<br>(A) |                                  |                              |                        | 120 Hz<br>(ohms)    | 20 kHz<br>(ohms) | 120 Hz<br>(A)           | 20 kHz<br>(A) |                                  |
| <b>10 Vdc (13 Vdc Surge)</b> |                        |                     |                  |                         |               |                                  | <b>16 Vdc (20 Vdc Surge)</b> |                        |                     |                  |                         |               |                                  |
| 4700                         | 381LX472M010H012       | 0.159               | 0.135            | 0.85                    | 0.98          | 22 x 25                          | 47000                        | 383LX473M016N042       | 0.020               | 0.018            | 5.50                    | 6.33          | 40 x 40                          |
| 6800                         | 381LX682M010H012       | 0.111               | 0.093            | 1.30                    | 1.50          | 22 x 25                          | 56000                        | 381LX563M016A452       | 0.020               | 0.018            | 6.00                    | 6.90          | 35 x 45                          |
| 10000                        | 381LX103M010H012       | 0.075               | 0.063            | 1.80                    | 2.10          | 22 x 25                          | 68000                        | 381LX683M016A452       | 0.020               | 0.018            | 6.50                    | 7.50          | 35 x 45                          |
| 12000                        | 381LX123M010H012       | 0.076               | 0.065            | 2.20                    | 2.63          | 22 x 25                          | 68000                        | 383LX683M016N052       | 0.015               | 0.014            | 7.30                    | 8.40          | 40 x 50                          |
| 15000                        | 381LX153M010H012       | 0.076               | 0.065            | 2.20                    | 2.53          | 22 x 25                          | 82000                        | 383LX823M016N062       | 0.017               | 0.013            | 7.70                    | 8.80          | 40 x 63                          |
| 18000                        | 381LX183M010H022       | 0.051               | 0.043            | 2.40                    | 2.76          | 22 x 30                          | 100000                       | 381LX104M016A082       | 0.015               | 0.013            | 8.00                    | 9.20          | 35 x 80                          |
| 22000                        | 381LX223M010H032       | 0.041               | 0.035            | 2.60                    | 2.99          | 22 x 35                          | 120000                       | 381LX124M016A082       | 0.015               | 0.013            | 8.50                    | 9.50          | 35 x 80                          |
| 27000                        | 381LX273M010J032       | 0.034               | 0.029            | 3.10                    | 3.57          | 25 x 35                          | 120000                       | 383LX124M016N082       | 0.014               | 0.012            | 8.80                    | 10.10         | 40 x 80                          |
| 33000                        | 381LX333M010J042       | 0.028               | 0.023            | 3.40                    | 3.91          | 25 x 40                          | 120000                       | 383LX124M016B052V      | 0.015               | 0.014            | 9.02                    | 10.37         | 50 x 50                          |
| 39000                        | 381LX393M010K032       | 0.026               | 0.023            | 3.70                    | 4.26          | 30 x 35                          | 150000                       | 383LX154M016N102       | 0.013               | 0.012            | 9.88                    | 11.36         | 40 x 105                         |
| 39000                        | 381LX393M010A022       | 0.025               | 0.020            | 3.70                    | 4.30          | 35 x 30                          | 150000                       | 383LX154M016B062V      | 0.014               | 0.013            | 10.15                   | 11.67         | 50 x 63                          |
| 47000                        | 381LX473M010K032       | 0.024               | 0.022            | 4.20                    | 4.83          | 30 x 35                          | 180000                       | 383LX184M016B082V      | 0.013               | 0.012            | 11.02                   | 12.67         | 50 x 80                          |
| 56000                        | 381LX563M010K042       | 0.023               | 0.021            | 5.00                    | 5.75          | 30 x 40                          | 220000                       | 383LX224M016B092V      | 0.012               | 0.011            | 11.71                   | 13.47         | 50 x 92                          |
| 68000                        | 381LX683M010K452       | 0.022               | 0.019            | 5.40                    | 6.21          | 30 x 45                          | 250000                       | 383LX254M016B102V      | 0.011               | 0.010            | 12.31                   | 14.16         | 50 x 105                         |
| 68000                        | 383LX683M010N042       | 0.023               | 0.022            | 5.40                    | 6.20          | 40 x 40                          | <b>25 Vdc (32 Vdc Surge)</b> |                        |                     |                  |                         |               |                                  |
| 82000                        | 383LX823M010N052       | 0.018               | 0.017            | 7.40                    | 8.50          | 40 x 50                          | 2200                         | 381LX222M025H202       | 0.240               | 0.180            | 1.30                    | 1.50          | 22 x 20                          |
| 120000                       | 383L124M010N062        | 0.012               | 0.008            | 7.10                    | 8.60          | 40 x 63                          | 3300                         | 381LX332M025H012       | 0.160               | 0.120            | 1.60                    | 1.80          | 22 x 25                          |
| 150000                       | 383L154M010N082        | 0.009               | 0.006            | 8.90                    | 10.60         | 40 x 80                          | 4700                         | 381LX472M025H012       | 0.105               | 0.080            | 2.00                    | 2.30          | 22 x 25                          |
| <b>16 Vdc (20 Vdc Surge)</b> |                        |                     |                  |                         |               |                                  | 5600                         | 381LX562M025H012       | 0.090               | 0.070            | 2.20                    | 2.50          | 22 x 25                          |
| 3300                         | 381LX332M016H012       | 0.213               | 0.170            | 1.30                    | 1.50          | 22 x 25                          | 6800                         | 381LX682M025H022       | 0.085               | 0.064            | 2.40                    | 2.76          | 22 x 30                          |
| 4700                         | 381LX472M016H012       | 0.150               | 0.120            | 1.60                    | 1.80          | 22 x 25                          | 6800                         | 381LX682M025J012       | 0.070               | 0.055            | 2.40                    | 2.80          | 25 x 25                          |
| 6800                         | 381LX682M016H012       | 0.090               | 0.067            | 2.20                    | 2.50          | 22 x 25                          | 8200                         | 381LX822M025H022       | 0.071               | 0.053            | 2.70                    | 3.11          | 22 x 30                          |
| 6800                         | 381LX682M016J202       | 0.110               | 0.092            | 1.80                    | 2.10          | 25 x 20                          | 10000                        | 381LX103M025J022       | 0.058               | 0.044            | 3.00                    | 3.45          | 25 x 30                          |
| 8200                         | 381LX822M016H012       | 0.110               | 0.092            | 1.80                    | 2.10          | 22 x 25                          | 12000                        | 381LX123M025J022       | 0.048               | 0.036            | 3.20                    | 3.68          | 25 x 30                          |
| 10000                        | 381LX103M016H012       | 0.075               | 0.063            | 2.60                    | 2.99          | 22 x 25                          | 12000                        | 381LX123M025A012       | 0.044               | 0.033            | 3.20                    | 3.70          | 35 x 25                          |
| 10000                        | 381LX103M016J012       | 0.120               | 0.086            | 2.60                    | 3.00          | 25 x 25                          | 15000                        | 381LX153M025J032       | 0.039               | 0.029            | 3.60                    | 4.14          | 25 x 35                          |
| 12000                        | 381LX123M016H022       | 0.062               | 0.053            | 2.90                    | 3.34          | 22 x 30                          | 15000                        | 381LX153M025J452       | 0.036               | 0.031            | 3.60                    | 4.10          | 25 x 45                          |
| 15000                        | 381LX153M016J022       | 0.046               | 0.307            | 3.20                    | 3.70          | 25 x 30                          | 15000                        | 381LX153M025A022       | 0.036               | 0.031            | 3.60                    | 4.10          | 35 x 30                          |
| 15000                        | 381LX153M016J032       | 0.080               | 0.064            | 3.20                    | 3.70          | 25 x 35                          | 18000                        | 381LX183M025J042       | 0.032               | 0.024            | 3.90                    | 4.49          | 25 x 40                          |
| 15000                        | 381LX153M016K022       | 0.080               | 0.064            | 3.20                    | 3.70          | 30 x 30                          | 18000                        | 381LX183M025J052       | 0.030               | 0.027            | 3.90                    | 4.50          | 25 x 50                          |
| 18000                        | 381LX183M016H032       | 0.041               | 0.035            | 3.50                    | 4.03          | 22 x 35                          | 22000                        | 381LX223M025J452       | 0.026               | 0.020            | 4.30                    | 4.95          | 25 x 45                          |
| 22000                        | 381LX223M016H042       | 0.034               | 0.029            | 3.80                    | 4.37          | 22 x 40                          | 22000                        | 381LX223M025K452       | 0.025               | 0.022            | 4.30                    | 4.90          | 30 x 45                          |
| 22000                        | 381LX223M016J452       | 0.033               | 0.028            | 3.80                    | 4.40          | 25 x 45                          | 22000                        | 381LX223M025A032       | 0.030               | 0.026            | 4.30                    | 4.90          | 35 x 35                          |
| 27000                        | 381LX273M016H052       | 0.028               | 0.023            | 4.20                    | 4.83          | 22 x 50                          | 27000                        | 381LX273M025K042       | 0.021               | 0.019            | 4.80                    | 5.50          | 30 x 40                          |
| 27000                        | 381LX273M016J052       | 0.030               | 0.025            | 4.20                    | 4.80          | 25 x 50                          | 27000                        | 383L273M025N042        | 0.020               | 0.013            | 4.60                    | 5.60          | 40 x 40                          |
| 27000                        | 381LX273M016K022       | 0.028               | 0.023            | 4.20                    | 4.83          | 30 x 30                          | 33000                        | 381LX333M025K452       | 0.018               | 0.014            | 5.50                    | 6.33          | 30 x 45                          |
| 33000                        | 381LX333M016K032       | 0.023               | 0.020            | 4.70                    | 5.41          | 30 x 35                          | 33000                        | 383LX333M025N042       | 0.018               | 0.016            | 5.50                    | 6.33          | 40 x 40                          |
| 33000                        | 381LX333M016K452       | 0.023               | 0.020            | 4.70                    | 5.40          | 30 x 45                          | 39000                        | 383L393M025N052        | 0.015               | 0.010            | 5.80                    | 7.00          | 40 x 50                          |
| 39000                        | 381LX393M016K042       | 0.022               | 0.020            | 5.10                    | 5.87          | 30 x 40                          | 47000                        | 381LX473M025A052       | 0.017               | 0.015            | 6.50                    | 4.25          | 35 x 50                          |
| 47000                        | 381LX473M016K452       | 0.021               | 0.019            | 5.50                    | 6.33          | 30 x 45                          | 47000                        | 383LX473M025N052       | 0.015               | 0.014            | 6.50                    | 7.40          | 40 x 50                          |
| 47000                        | 381LX473M016A452       | 0.020               | 0.018            | 5.50                    | 6.30          | 35 x 45                          | 47000                        | 383L473M025N062        | 0.012               | 0.008            | 6.90                    | 8.30          | 40 x 63                          |
|                              |                        |                     |                  |                         |               |                                  | 56000                        | 383LX563M025N062       | 0.015               | 0.012            | 7.20                    | 8.25          | 40 x 63                          |

# Type 381LX / 383LX 105 °C High Ripple, Snap-In Aluminum

High Ripple, Long Life, 2,4 and 5 pin styles available

| Cap.<br>(µF)                 | Catalog<br>Part Number | Max. ESR<br>@ +25°C |                  | Ripple Amps<br>@ +105°C |               | Nominal<br>Size | Cap.<br>(µF)                 | Catalog<br>Part Number | Max. ESR<br>@ +25°C |                  | Ripple Amps<br>@ +105°C |               | Nominal<br>Size |
|------------------------------|------------------------|---------------------|------------------|-------------------------|---------------|-----------------|------------------------------|------------------------|---------------------|------------------|-------------------------|---------------|-----------------|
|                              |                        | 120 Hz<br>(ohms)    | 20 kHz<br>(ohms) | 120 Hz<br>(A)           | 20 kHz<br>(A) |                 |                              |                        | D x L<br>(mm)       | 120 Hz<br>(ohms) | 20 kHz<br>(ohms)        | 120 Hz<br>(A) |                 |
| <b>25 Vdc (32 Vdc Surge)</b> |                        |                     |                  |                         |               |                 | <b>35 Vdc (44 Vdc Surge)</b> |                        |                     |                  |                         |               |                 |
| 68000                        | 383L683M025N082        | 0.009               | 0.007            | 8.70                    | 10.20         | 40 x 80         | 68000                        | 383LX683M035B082V      | 0.017               | 0.013            | 10.07                   | 11.58         | 50 x 80         |
| 82000                        | 383LX823M025N082       | 0.014               | 0.011            | 8.70                    | 10.00         | 40 x 80         | 82000                        | 383LX823M035B092V      | 0.015               | 0.011            | 10.89                   | 12.52         | 50 x 92         |
| 82000                        | 383LX823M025B052V      | 0.016               | 0.015            | 9.20                    | 10.58         | 50 x 50         | 100000                       | 383LX104M035B102V      | 0.013               | 0.010            | 11.75                   | 13.51         | 50 x 105        |
| 100000                       | 383LX104M025N102       | 0.012               | 0.010            | 9.76                    | 11.22         | 40 x 105        | <b>50 Vdc (63 Vdc Surge)</b> |                        |                     |                  |                         |               |                 |
| 100000                       | 383LX104M025B062V      | 0.015               | 0.013            | 10.02                   | 11.52         | 50 x 63         | 1000                         | 381LX102M050H202       | 0.260               | 0.200            | 0.90                    | 1.00          | 22 x 20         |
| 120000                       | 383LX124M025B082V      | 0.013               | 0.012            | 10.93                   | 12.57         | 50 x 80         | 1500                         | 381LX152M050H012       | 0.155               | 0.120            | 1.25                    | 1.45          | 22 x 25         |
| 150000                       | 383LX154M025B092V      | 0.012               | 0.011            | 11.70                   | 13.46         | 50 x 92         | 1800                         | 381LX182M050H012       | 0.129               | 0.097            | 1.50                    | 1.70          | 22 x 25         |
| 180000                       | 383LX184M025B102V      | 0.010               | 0.009            | 12.42                   | 14.28         | 50 x 105        | 2200                         | 381LX222M050H012       | 0.129               | 0.097            | 1.50                    | 1.70          | 22 x 25         |
| <b>35 Vdc (44 Vdc Surge)</b> |                        |                     |                  |                         |               |                 | 2700                         | 381LX272M050H012       | 0.154               | 0.115            | 1.80                    | 2.07          | 22 x 25         |
| 1500                         | 381LX152M035H012       | 0.287               | 0.216            | 1.10                    | 1.30          | 22 x 25         | 2700                         | 381LX272M050J012       | 0.086               | 0.064            | 1.80                    | 2.10          | 25 x 25         |
| 2200                         | 381LX222M035H012       | 0.200               | 0.150            | 1.40                    | 1.60          | 22 x 25         | 3300                         | 381LX332M050H012       | 0.126               | 0.094            | 2.00                    | 2.30          | 22 x 25         |
| 3300                         | 381LX332M035H012       | 0.121               | 0.091            | 1.90                    | 2.20          | 22 x 25         | 3300                         | 381LX332M050J022       | 0.070               | 0.053            | 2.00                    | 2.30          | 25 x 30         |
| 3300                         | 381LX332M035K202       | 0.130               | 0.100            | 1.70                    | 2.00          | 30 x 20         | 3900                         | 381LX392M050J012       | 0.106               | 0.080            | 2.20                    | 2.53          | 25 x 25         |
| 3900                         | 381LX392M035H012       | 0.110               | 0.080            | 2.00                    | 2.30          | 22 x 25         | 3900                         | 381LX392M050K012       | 0.065               | 0.050            | 2.20                    | 2.50          | 30 x 25         |
| 4700                         | 381LX472M035H022       | 0.090               | 0.070            | 2.20                    | 2.50          | 22 x 30         | 4700                         | 381LX472M050J022       | 0.053               | 0.040            | 2.50                    | 2.90          | 25 x 30         |
| 4700                         | 381LX472M035J012       | 0.090               | 0.070            | 2.20                    | 2.50          | 25 x 25         | 4700                         | 381LX472M050A012       | 0.053               | 0.040            | 2.50                    | 2.90          | 35 x 25         |
| 5600                         | 381LX562M035H032       | 0.071               | 0.054            | 2.40                    | 2.80          | 22 x 35         | 5600                         | 381LX562M050J032       | 0.074               | 0.056            | 2.80                    | 3.22          | 25 x 35         |
| 5600                         | 381LX562M035J012       | 0.041               | 0.054            | 2.40                    | 2.80          | 25 x 25         | 5600                         | 381LX562M050A022       | 0.050               | 0.038            | 2.80                    | 3.20          | 35 x 30         |
| 6800                         | 381LX682M035J022       | 0.073               | 0.055            | 2.60                    | 2.99          | 25 x 30         | 6800                         | 381LX682M050H452       | 0.061               | 0.046            | 3.30                    | 3.80          | 22 x 45         |
| 6800                         | 381LX682M035K022       | 0.059               | 0.045            | 2.60                    | 3.00          | 30 x 30         | 6800                         | 381LX682M050A022       | 0.046               | 0.035            | 3.30                    | 3.80          | 35 x 30         |
| 8200                         | 381LX822M035J022       | 0.049               | 0.037            | 2.90                    | 3.30          | 25 x 30         | 8200                         | 381LX822M050K452       | 0.051               | 0.038            | 3.60                    | 4.10          | 30 x 45         |
| 8200                         | 381LX822M035A012       | 0.049               | 0.037            | 2.90                    | 3.30          | 35 x 25         | 8200                         | 381LX822M050A032       | 0.040               | 0.030            | 3.60                    | 4.10          | 35 x 35         |
| 10000                        | 381LX103M035J032       | 0.050               | 0.037            | 3.20                    | 3.68          | 25 x 35         | 10000                        | 381LX103M050J052       | 0.041               | 0.031            | 4.00                    | 4.60          | 25 x 50         |
| 10000                        | 381LX103M035J452       | 0.040               | 0.030            | 3.20                    | 3.70          | 25 x 45         | 10000                        | 381LX103M050K052       | 0.033               | 0.025            | 4.00                    | 4.60          | 30 x 50         |
| 10000                        | 381LX103M035A022       | 0.040               | 0.030            | 3.20                    | 3.70          | 35 x 30         | 10000                        | 381LX103M050A042       | 0.033               | 0.025            | 4.00                    | 4.60          | 35 x 40         |
| 12000                        | 381LX123M035J042       | 0.041               | 0.031            | 3.50                    | 4.03          | 25 x 40         | 12000                        | 381LX123M050A452       | 0.028               | 0.021            | 4.50                    | 5.20          | 35 x 45         |
| 12000                        | 381LX123M035J052       | 0.033               | 0.025            | 3.50                    | 4.00          | 25 x 50         | 12000                        | 383L123M050N042        | 0.029               | 0.018            | 3.80                    | 4.80          | 40 x 40         |
| 12000                        | 381LX123M035A022       | 0.033               | 0.025            | 3.50                    | 4.00          | 35 x 30         | 15000                        | 381LX153M050K452       | 0.028               | 0.022            | 4.80                    | 5.52          | 30 x 45         |
| 15000                        | 381LX153M035K042       | 0.033               | 0.025            | 3.90                    | 4.49          | 30 x 40         | 15000                        | 383LX153M050N042       | 0.022               | 0.018            | 4.80                    | 5.52          | 40 x 40         |
| 15000                        | 381LX153M035K452       | 0.030               | 0.020            | 3.90                    | 4.50          | 30 x 45         | 15000                        | 383L153M050N052        | 0.021               | 0.013            | 4.90                    | 6.10          | 40 x 50         |
| 15000                        | 381LX153M035A032       | 0.030               | 0.020            | 3.90                    | 4.50          | 35 x 35         | 18000                        | 381LX183M050A452       | 0.023               | 0.018            | 5.60                    | 6.44          | 35 x 45         |
| 18000                        | 381LX183M035K452       | 0.028               | 0.021            | 4.30                    | 4.95          | 30 x 45         | 18000                        | 383L183M050N062        | 0.017               | 0.011            | 5.80                    | 7.20          | 40 x 63         |
| 22000                        | 381LX223M035A052       | 0.023               | 0.017            | 5.00                    | 5.80          | 35 x 50         | 22000                        | 383LX223M050N052       | 0.016               | 0.013            | 5.10                    | 5.90          | 40 x 50         |
| 22000                        | 383LX223M035N042       | 0.023               | 0.017            | 5.00                    | 5.75          | 40 x 40         | 27000                        | 383LX273M050N062       | 0.015               | 0.012            | 6.05                    | 6.96          | 40 x 63         |
| 27000                        | 381LX273M035A052       | 0.018               | 0.014            | 5.30                    | 6.10          | 35 x 50         | 27000                        | 383L273M050N082        | 0.013               | 0.009            | 7.40                    | 9.00          | 40 x 80         |
| 27000                        | 383LX273M035N052       | 0.020               | 0.015            | 5.45                    | 6.25          | 40 x 50         | 33000                        | 383LX333M050B052V      | 0.018               | 0.014            | 7.75                    | 8.91          | 50 x 50         |
| 33000                        | 383L333M035N062        | 0.019               | 0.014            | 6.60                    | 7.60          | 40 x 63         | 39000                        | 383LX393M050N082       | 0.013               | 0.010            | 6.20                    | 7.10          | 40 x 80         |
| 39000                        | 381LX393M035A052       | 0.017               | 0.014            | 6.50                    | 7.50          | 35 x 50         | 39000                        | 383LX393M050B062V      | 0.016               | 0.013            | 8.40                    | 9.66          | 50 x 63         |
| 47000                        | 383L473M035N082        | 0.018               | 0.013            | 7.80                    | 9.00          | 40 x 80         | 47000                        | 383LX473M050N102       | 0.012               | 0.010            | 8.18                    | 9.41          | 40 x 105        |
| 47000                        | 383LX473M035B052V      | 0.021               | 0.016            | 8.25                    | 9.49          | 50 x 50         | 47000                        | 383LX473M050B082V      | 0.014               | 0.011            | 9.19                    | 10.57         | 50 x 80         |
| 56000                        | 383LX563M035B062V      | 0.019               | 0.014            | 9.07                    | 10.43         | 50 x 63         | 56000                        | 383LX563M050B092V      | 0.012               | 0.009            | 9.79                    | 11.26         | 50 x 92         |
| 68000                        | 383LX683M035N102       | 0.016               | 0.012            | 9.27                    | 10.66         | 40 x 105        | 68000                        | 383LX683M050B102V      | 0.011               | 0.009            | 10.40                   | 12.00         | 50 x 105        |

# Type 381LX / 383LX 105 °C High Ripple, Snap-In Aluminum

High Ripple, Long Life, 2,4 and 5 pin styles available

| Cap.<br>(µF)                 | Catalog<br>Part Number | Max. ESR         |                  | Ripple Amps   |               | Nominal       | Cap.<br>(µF)                   | Catalog<br>Part Number | Max. ESR         |                  | Ripple Amps   |               | Nominal       |
|------------------------------|------------------------|------------------|------------------|---------------|---------------|---------------|--------------------------------|------------------------|------------------|------------------|---------------|---------------|---------------|
|                              |                        | @ +25°C          |                  | @ +105°C      |               | Size          |                                |                        | @ +25°C          |                  | @ +105°C      |               | Size          |
|                              |                        | 120 Hz<br>(ohms) | 20 kHz<br>(ohms) | 120 Hz<br>(A) | 20 kHz<br>(A) | D x L<br>(mm) |                                |                        | 120 Hz<br>(ohms) | 20 kHz<br>(ohms) | 120 Hz<br>(A) | 20 kHz<br>(A) | D x L<br>(mm) |
| <b>63 Vdc (79 Vdc Surge)</b> |                        |                  |                  |               |               |               | <b>80 Vdc (100 Vdc Surge)</b>  |                        |                  |                  |               |               |               |
| 680                          | 381LX681M063H012       | 0.410            | 0.310            | 0.90          | 1.00          | 22 x 25       | 470                            | 381LX471M080H012       | 0.390            | 0.270            | 0.80          | 0.90          | 22 x 25       |
| 1000                         | 381LX102M063H012       | 0.280            | 0.210            | 1.18          | 1.35          | 22 x 25       | 680                            | 381LX681M080H012       | 0.270            | 0.190            | 1.00          | 1.15          | 22 x 25       |
| 1200                         | 381LX122M063H012       | 0.235            | 0.180            | 1.40          | 1.60          | 22 x 25       | 820                            | 381LX821M080H012       | 0.222            | 0.145            | 1.20          | 1.40          | 22 x 25       |
| 1500                         | 381LX152M063H012       | 0.235            | 0.180            | 1.50          | 1.70          | 22 x 25       | 1000                           | 381LX102M080H012       | 0.222            | 0.145            | 1.20          | 1.40          | 22 x 25       |
| 1800                         | 381LX182M063H022       | 0.157            | 0.117            | 1.70          | 1.96          | 22 x 30       | 1000                           | 381LX102M080J012       | 0.182            | 0.120            | 1.30          | 1.50          | 25 x 25       |
| 1800                         | 381LX182M063J012       | 0.123            | 0.092            | 2.20          | 2.53          | 25 x 25       | 1200                           | 381LX122M080H022       | 0.235            | 0.176            | 1.50          | 1.73          | 22 x 30       |
| 2200                         | 381LX222M063H022       | 0.143            | 0.110            | 1.50          | 1.70          | 22 x 30       | 1500                           | 381LX152M080H032       | 0.188            | 0.141            | 1.70          | 1.96          | 22 x 35       |
| 2700                         | 381LX272M063H042       | 0.123            | 0.092            | 2.20          | 2.53          | 22 x 40       | 1800                           | 381LX182M080J032       | 0.147            | 0.080            | 1.80          | 2.10          | 25 x 35       |
| 2700                         | 381LX272M063K012       | 0.105            | 0.080            | 2.20          | 2.50          | 30 x 25       | 1800                           | 381LX182M080K012       | 0.111            | 0.080            | 1.80          | 2.10          | 30 x 25       |
| 3300                         | 381LX332M063J022       | 0.090            | 0.070            | 2.50          | 2.90          | 25 x 30       | 2200                           | 381LX222M080H452       | 0.121            | 0.092            | 2.10          | 2.40          | 22 x 45       |
| 3300                         | 381LX332M063A012       | 0.090            | 0.070            | 2.50          | 2.90          | 35 x 25       | 2200                           | 381LX222M080A012       | 0.090            | 0.063            | 2.10          | 2.40          | 35 x 25       |
| 3900                         | 381LX392M063J022       | 0.085            | 0.064            | 2.70          | 3.11          | 25 x 30       | 2700                           | 381LX272M080J042       | 0.104            | 0.078            | 2.40          | 2.76          | 25 x 40       |
| 3900                         | 381LX392M063J452       | 0.080            | 0.060            | 2.70          | 3.10          | 25 x 45       | 3300                           | 381LX332M080J052       | 0.065            | 0.049            | 2.60          | 3.00          | 25 x 50       |
| 4700                         | 381LX472M063K042       | 0.063            | 0.048            | 3.00          | 3.50          | 30 x 40       | 3300                           | 381LX332M080K042       | 0.100            | 0.075            | 2.60          | 3.00          | 30 x 40       |
| 5600                         | 381LX562M063K042       | 0.059            | 0.044            | 3.30          | 3.80          | 30 x 40       | 3300                           | 381LX332M080A022       | 0.065            | 0.049            | 2.60          | 3.00          | 35 x 30       |
| 5600                         | 381LX562M063K452       | 0.055            | 0.040            | 3.30          | 3.80          | 30 x 45       | 3900                           | 381LX392M080K042       | 0.072            | 0.054            | 3.00          | 3.45          | 30 x 40       |
| 5600                         | 381LX562M063A032       | 0.055            | 0.040            | 3.30          | 3.80          | 35 x 35       | 4700                           | 381LX472M080K042       | 0.060            | 0.045            | 3.30          | 3.80          | 30 x 40       |
| 6800                         | 381LX682M063J052       | 0.050            | 0.040            | 3.60          | 4.10          | 25 x 50       | 4700                           | 381LX472M080K052       | 0.048            | 0.036            | 3.30          | 3.80          | 30 x 50       |
| 6800                         | 381LX682M063K042       | 0.049            | 0.037            | 3.60          | 4.14          | 30 x 40       | 4700                           | 381LX472M080A042       | 0.048            | 0.036            | 3.30          | 3.80          | 35 x 40       |
| 6800                         | 381LX682M063K052       | 0.050            | 0.040            | 3.60          | 4.10          | 30 x 50       | 5600                           | 381LX562M080A052       | 0.072            | 0.054            | 3.00          | 3.45          | 35 x 50       |
| 8200                         | 381LX822M063J052       | 0.040            | 0.030            | 3.90          | 4.50          | 25 x 50       | 5600                           | 383L562M080N042        | 0.035            | 0.022            | 3.50          | 4.40          | 40 x 40       |
| 8200                         | 381LX822M063A452       | 0.040            | 0.030            | 3.90          | 4.50          | 35 x 45       | 6800                           | 381LX682M080A052       | 0.041            | 0.031            | 3.90          | 4.50          | 35 x 50       |
| 8200                         | 383L822M063N042        | 0.031            | 0.018            | 3.70          | 4.80          | 40 x 40       | 6800                           | 383LX682M080N042       | 0.041            | 0.031            | 3.90          | 4.49          | 40 x 40       |
| 10000                        | 381LX103M063K452       | 0.033            | 0.028            | 4.40          | 5.10          | 30 x 45       | 8200                           | 383L822M080N052        | 0.025            | 0.016            | 4.40          | 5.60          | 40 x 50       |
| 10000                        | 381LX103M063K052       | 0.033            | 0.028            | 4.40          | 5.10          | 30 x 50       | 10000                          | 383L103M080N062        | 0.021            | 0.013            | 5.30          | 6.70          | 40 x 63       |
| 12000                        | 381LX123M063K052       | 0.030            | 0.025            | 4.40          | 5.06          | 30 x 50       | 12000                          | 383LX123M080B052V      | 0.035            | 0.026            | 6.03          | 6.93          | 50 x 50       |
| 12000                        | 383LX123M063N042       | 0.030            | 0.028            | 4.52          | 5.20          | 40 x 40       | 15000                          | 383L153M080N082        | 0.015            | 0.010            | 6.80          | 8.40          | 40 x 80       |
| 12000                        | 383L123M063N052        | 0.022            | 0.013            | 4.70          | 6.10          | 40 x 50       | 15000                          | 383LX153M080B062V      | 0.028            | 0.021            | 6.65          | 7.65          | 50 x 63       |
| 15000                        | 381LX153M063A052       | 0.024            | 0.023            | 4.90          | 5.70          | 35 x 50       | 18000                          | 383LX183M080B082V      | 0.026            | 0.019            | 7.29          | 8.38          | 50 x 80       |
| 15000                        | 383LX153M063N052       | 0.027            | 0.023            | 4.80          | 5.50          | 40 x 50       | 22000                          | 383LX223M080N102       | 0.019            | 0.014            | 6.95          | 7.99          | 40 x 105      |
| 15000                        | 383L153M063N062        | 0.018            | 0.011            | 5.70          | 7.20          | 40 x 63       | 22000                          | 383LX223M080B092V      | 0.022            | 0.016            | 7.83          | 9.00          | 50 x 92       |
| 18000                        | 381LX183M063A082       | 0.022            | 0.019            | 5.80          | 6.70          | 35 x 80       | 27000                          | 383LX273M080B102V      | 0.018            | 0.014            | 8.38          | 9.64          | 50 x 105      |
| 18000                        | 383LX183M063N062       | 0.023            | 0.020            | 5.40          | 6.20          | 40 x 63       | <b>100 Vdc (125 Vdc Surge)</b> |                        |                  |                  |               |               |               |
| 22000                        | 383L223M063N082        | 0.013            | 0.009            | 7.20          | 9.00          | 40 x 80       | 330                            | 381LX331M100H012       | 0.653            | 0.392            | 0.80          | 1.20          | 22 x 25       |
| 22000                        | 383LX223M063B052V      | 0.019            | 0.016            | 6.76          | 7.77          | 50 x 50       | 470                            | 381LX471M100H012       | 0.390            | 0.230            | 0.92          | 1.40          | 22 x 25       |
| 27000                        | 383LX273M063N082       | 0.017            | 0.014            | 6.60          | 7.60          | 40 x 80       | 560                            | 381LX561M100H012       | 0.300            | 0.180            | 1.10          | 1.30          | 22 x 25       |
| 27000                        | 383LX273M063B062V      | 0.017            | 0.014            | 7.34          | 8.44          | 50 x 63       | 680                            | 381LX681M100H012       | 0.300            | 0.180            | 1.10          | 1.30          | 22 x 25       |
| 33000                        | 383LX333M063B082V      | 0.015            | 0.013            | 8.00          | 9.20          | 50 x 80       | 820                            | 381LX821M100H012       | 0.303            | 0.197            | 1.40          | 1.60          | 22 x 25       |
| 39000                        | 383LX393M063N102       | 0.014            | 0.012            | 7.53          | 8.66          | 40 x 105      | 820                            | 381LX821M100J012       | 0.202            | 0.120            | 1.40          | 2.10          | 25 x 25       |
| 39000                        | 383LX393M063B092V      | 0.014            | 0.012            | 8.48          | 9.75          | 50 x 92       | 1000                           | 381LX102M100H022       | 0.182            | 0.110            | 1.70          | 2.55          | 22 x 30       |
| 47000                        | 383LX473M063B102V      | 0.012            | 0.010            | 8.99          | 10.34         | 50 x 105      | 1200                           | 381LX122M100H022       | 0.195            | 0.125            | 1.85          | 2.70          | 22 x 30       |
|                              |                        |                  |                  |               |               |               | 1200                           | 381LX122M100H032       | 0.195            | 0.125            | 1.85          | 2.70          | 22 x 35       |

# Type 381LX / 383LX 105 °C High Ripple, Snap-In Aluminum

High Ripple, Long Life, 2,4 and 5 pin styles available

| Cap.<br>(µF)                   | Catalog<br>Part Number | Max. ESR         |                  | Ripple Amps   |               | Nominal       |
|--------------------------------|------------------------|------------------|------------------|---------------|---------------|---------------|
|                                |                        | @ +25°C          |                  | @ +105°C      |               | Size          |
|                                |                        | 120 Hz<br>(ohms) | 20 kHz<br>(ohms) | 120 Hz<br>(A) | 20 kHz<br>(A) | D x L<br>(mm) |
| <b>100 Vdc (125 Vdc Surge)</b> |                        |                  |                  |               |               |               |
| 1500                           | 381LX152M100H042       | 0.155            | 0.100            | 2.30          | 2.80          | 22 x 40       |
| 1500                           | 381LX152M100K012       | 0.155            | 0.100            | 2.30          | 2.80          | 30 x 25       |
| 1800                           | 381LX182M100J042       | 0.138            | 0.090            | 2.30          | 2.65          | 25 x 40       |
| 2200                           | 381LX222M100J042       | 0.121            | 0.080            | 2.60          | 2.99          | 25 x 40       |
| 2200                           | 381LX222M100J452       | 0.090            | 0.060            | 2.60          | 3.90          | 25 x 45       |
| 2700                           | 381LX272M100A022       | 0.092            | 0.060            | 2.90          | 3.34          | 35 x 30       |
| 3300                           | 381LX332M100K052       | 0.075            | 0.053            | 3.20          | 4.80          | 30 x 50       |
| 3300                           | 381LX332M100A042       | 0.075            | 0.053            | 3.20          | 4.80          | 35 x 40       |
| 3900                           | 381LX392M100K052       | 0.064            | 0.043            | 3.60          | 4.14          | 30 x 50       |
| 4700                           | 381LX472M100A052       | 0.053            | 0.040            | 3.80          | 5.70          | 35 x 50       |
| 4700                           | 383LX472M100N042       | 0.053            | 0.040            | 3.80          | 5.70          | 40 x 40       |
| 5600                           | 381LX562M100A052       | 0.044            | 0.033            | 4.10          | 4.70          | 35 x 50       |
| 5600                           | 383L562M100N062        | 0.027            | 0.012            | 4.60          | 6.50          | 40 x 63       |
| 6800                           | 383LX682M100N052       | 0.037            | 0.027            | 4.60          | 5.30          | 40 x 50       |
| 8200                           | 383LX822M100N062       | 0.030            | 0.023            | 5.00          | 5.77          | 40 x 63       |
| 8200                           | 383L822M100N082        | 0.020            | 0.009            | 6.00          | 8.20          | 40 x 80       |
| 8200                           | 383LX822M100B052V      | 0.030            | 0.023            | 6.14          | 7.06          | 50 x 50       |
| 10000                          | 381LX103M100A082       | 0.033            | 0.025            | 6.38          | 7.34          | 35 x 80       |
| 12000                          | 383LX123M100N082       | 0.021            | 0.016            | 6.44          | 7.40          | 40 x 80       |
| 12000                          | 383LX123M100B062V      | 0.022            | 0.017            | 7.17          | 8.25          | 50 x 63       |
| 15000                          | 383LX153M100N102       | 0.017            | 0.012            | 7.37          | 8.48          | 40 x 105      |
| 15000                          | 383LX153M100B082V      | 0.019            | 0.014            | 8.01          | 9.21          | 50 x 80       |
| 18000                          | 383LX183M100B092V      | 0.017            | 0.012            | 8.64          | 9.94          | 50 x 92       |
| 22000                          | 383LX223M100B102V      | 0.015            | 0.011            | 9.32          | 10.72         | 50 x 105      |
| <b>160 Vdc (200 Vdc Surge)</b> |                        |                  |                  |               |               |               |
| 470                            | 381LX471M160H022       | 0.423            | 0.190            | 1.40          | 2.00          | 22 x 30       |
| 560                            | 381LX561M160H032       | 0.355            | 0.160            | 1.50          | 2.10          | 22 x 35       |
| 680                            | 381LX681M160H042       | 0.293            | 0.132            | 1.70          | 2.40          | 22 x 40       |
| 820                            | 381LX821M160J042       | 0.243            | 0.109            | 2.00          | 2.80          | 25 x 40       |
| 1000                           | 381LX102M160J042       | 0.216            | 0.108            | 2.20          | 3.08          | 25 x 40       |
| 1200                           | 381LX122M160K032       | 0.180            | 0.090            | 2.30          | 3.20          | 30 x 35       |
| 1500                           | 381LX152M160K452       | 0.155            | 0.077            | 2.50          | 3.50          | 30 x 45       |
| 1800                           | 381LX182M160K452       | 0.111            | 0.055            | 2.70          | 3.78          | 30 x 45       |
| 2200                           | 381LX222M160K052       | 0.098            | 0.049            | 2.90          | 4.06          | 30 x 50       |
| 2200                           | 383LX222M160N042       | 0.100            | 0.060            | 2.90          | 4.10          | 40 x 40       |
| 2700                           | 383L272M160N062        | 0.045            | 0.027            | 3.80          | 5.00          | 40 x 63       |
| 3300                           | 383LX332M160N052       | 0.070            | 0.040            | 3.40          | 4.70          | 40 x 40       |
| <b>180 Vdc (225 Vdc Surge)</b> |                        |                  |                  |               |               |               |
| 270                            | 381LX271M180H012       | 0.737            | 0.376            | 1.10          | 1.50          | 22 x 25       |
| 330                            | 381LX331M180H022       | 0.603            | 0.308            | 1.20          | 1.70          | 22 x 30       |
| 390                            | 381LX391M180J012       | 0.510            | 0.260            | 1.30          | 1.80          | 25 x 25       |
| 470                            | 381LX471M180H032       | 0.423            | 0.216            | 1.40          | 2.00          | 22 x 35       |

| Cap.<br>(µF)                   | Catalog<br>Part Number | Max. ESR         |                  | Ripple Amps   |               | Nominal       |
|--------------------------------|------------------------|------------------|------------------|---------------|---------------|---------------|
|                                |                        | @ +25°C          |                  | @ +105°C      |               | Size          |
|                                |                        | 120 Hz<br>(ohms) | 20 kHz<br>(ohms) | 120 Hz<br>(A) | 20 kHz<br>(A) | D x L<br>(mm) |
| <b>180 Vdc (225 Vdc Surge)</b> |                        |                  |                  |               |               |               |
| 560                            | 381LX561M180H042       | 0.355            | 0.181            | 1.50          | 2.10          | 22 x 40       |
| 680                            | 381LX681M180J032       | 0.293            | 0.149            | 1.70          | 2.38          | 25 x 35       |
| 820                            | 381LX821M180K022       | 0.243            | 0.124            | 2.00          | 2.80          | 30 x 30       |
| 1000                           | 381LX102M180J052       | 0.216            | 0.097            | 2.20          | 3.08          | 25 x 50       |
| 1200                           | 381LX122M180K452       | 0.166            | 0.085            | 2.30          | 3.20          | 30 x 45       |
| 1500                           | 381LX152M180K052       | 0.133            | 0.068            | 2.50          | 3.50          | 30 x 50       |
| 1800                           | 381LX182M180A452       | 0.111            | 0.050            | 2.70          | 3.80          | 35 x 45       |
| 1800                           | 383L182M180N052        | 0.059            | 0.033            | 3.10          | 4.20          | 40 x 50       |
| 2200                           | 381LX222M180A052       | 0.090            | 0.046            | 2.90          | 4.10          | 35 x 50       |
| 2200                           | 383L222M180N062        | 0.048            | 0.027            | 3.70          | 4.90          | 40 x 63       |
| 3300                           | 383L332M180N082        | 0.035            | 0.020            | 4.80          | 6.30          | 40 x 80       |
| <b>200 Vdc (250 Vdc Surge)</b> |                        |                  |                  |               |               |               |
| 100                            | 381LX101M200H012       | 1.660            | 0.750            | 0.50          | 0.70          | 22 x 25       |
| 150                            | 381LX151M200H012       | 1.100            | 0.500            | 0.70          | 0.95          | 22 x 25       |
| 220                            | 381LX221M200H012       | 0.754            | 0.339            | 1.00          | 1.40          | 22 x 25       |
| 270                            | 381LX271M200H012       | 0.730            | 0.300            | 1.10          | 1.50          | 22 x 25       |
| 270                            | 381LX271M200J012       | 0.614            | 0.276            | 1.10          | 1.50          | 25 x 25       |
| 330                            | 381LX331M200H022       | 0.603            | 0.308            | 1.25          | 1.79          | 22 x 30       |
| 330                            | 381LX331M200J012       | 0.603            | 0.308            | 1.20          | 1.70          | 25 x 25       |
| 390                            | 381LX391M200H022       | 0.510            | 0.230            | 1.30          | 1.80          | 22 x 30       |
| 470                            | 381LX471M200J022       | 0.423            | 0.190            | 1.40          | 2.00          | 25 x 30       |
| 470                            | 381LX471M200K012       | 0.353            | 0.159            | 1.40          | 2.00          | 30 x 25       |
| 560                            | 381LX561M200H042       | 0.355            | 0.160            | 1.50          | 2.10          | 22 x 40       |
| 560                            | 381LX561M200J022       | 0.355            | 0.160            | 1.50          | 2.10          | 25 x 30       |
| 680                            | 381LX681M200J042       | 0.293            | 0.132            | 1.70          | 2.40          | 25 x 40       |
| 680                            | 381LX681M200K022       | 0.244            | 0.110            | 1.70          | 2.40          | 30 x 30       |
| 820                            | 381LX821M200H452       | 0.263            | 0.118            | 2.00          | 2.80          | 22 x 45       |
| 820                            | 381LX821M200J042       | 0.243            | 0.109            | 2.04          | 2.92          | 25 x 40       |
| 820                            | 381LX821M200K022       | 0.263            | 0.118            | 2.00          | 2.80          | 30 x 30       |
| 1000                           | 381LX102M200J052       | 0.216            | 0.108            | 2.20          | 3.10          | 25 x 50       |
| 1000                           | 381LX102M200K032       | 0.216            | 0.108            | 2.20          | 3.10          | 30 x 35       |
| 1000                           | 381LX102M200K452       | 0.216            | 0.108            | 2.20          | 3.10          | 30 x 45       |
| 1000                           | 381LX102M200A022       | 0.216            | 0.108            | 2.20          | 3.10          | 35 x 30       |
| 1200                           | 381LX122M200K042       | 0.193            | 0.097            | 2.30          | 3.20          | 30 x 40       |
| 1200                           | 381LX122M200K052       | 0.193            | 0.097            | 2.30          | 3.20          | 30 x 50       |
| 1200                           | 381LX122M200A032       | 0.193            | 0.097            | 2.30          | 3.20          | 35 x 35       |
| 1500                           | 381LX152M200K052       | 0.155            | 0.077            | 2.50          | 3.50          | 30 x 50       |
| 1500                           | 381LX152M200A042       | 0.155            | 0.077            | 2.50          | 3.50          | 35 x 40       |
| 1800                           | 381LX182M200A452       | 0.129            | 0.077            | 2.70          | 3.80          | 35 x 45       |
| 1800                           | 383LX182M200N042       | 0.129            | 0.077            | 2.70          | 3.78          | 40 x 40       |
| 1800                           | 383L182M200N052        | 0.063            | 0.033            | 3.00          | 4.10          | 40 x 50       |
| 2200                           | 381LX222M200A052       | 0.105            | 0.063            | 2.90          | 4.00          | 35 x 50       |

# Type 381LX / 383LX 105 °C High Ripple, Snap-In Aluminum

High Ripple, Long Life, 2,4 and 5 pin styles available

| Cap.<br>(µF)                   | Catalog<br>Part Number | Max. ESR<br>@ +25°C |        | Ripple Amps<br>@ +105°C |        | Nominal<br>Size | Cap.<br>(µF)                   | Catalog<br>Part Number | Max. ESR<br>@ +25°C |        | Ripple Amps<br>@ +105°C |        | Nominal<br>Size |
|--------------------------------|------------------------|---------------------|--------|-------------------------|--------|-----------------|--------------------------------|------------------------|---------------------|--------|-------------------------|--------|-----------------|
|                                |                        | 120 Hz              | 20 kHz | 120 Hz                  | 20 kHz | D x L           |                                |                        | 120 Hz              | 20 kHz | 120 Hz                  | 20 kHz | D x L           |
|                                |                        | (ohms)              | (ohms) | (A)                     | (A)    | (mm)            |                                |                        | (ohms)              | (ohms) | (A)                     | (A)    | (mm)            |
| <b>200 Vdc (250 Vdc Surge)</b> |                        |                     |        |                         |        |                 | <b>250 Vdc (300 Vdc Surge)</b> |                        |                     |        |                         |        |                 |
| 2200                           | 383L222M200N062        | 0.051               | 0.027  | 3.60                    | 4.90   | 40 x 63         | 1800                           | 383L182M250N062        | 0.066               | 0.025  | 3.10                    | 5.10   | 40 x 63         |
| 2700                           | 383LX272M200N052       | 0.086               | 0.052  | 3.55                    | 4.97   | 40 x 50         | 2200                           | 381LX222M250A082       | 0.096               | 0.064  | 3.75                    | 5.25   | 35 x 80         |
| 2700                           | 383L272M200N082        | 0.032               | 0.018  | 4.60                    | 6.20   | 40 x 80         | 2200                           | 383LX222M250N062       | 0.098               | 0.064  | 3.70                    | 5.15   | 40 x 63         |
| 3300                           | 381LX332M200A082       | 0.065               | 0.039  | 4.50                    | 6.33   | 35 x 80         | 2200                           | 383L222M250N082        | 0.043               | 0.017  | 4.00                    | 6.40   | 40 x 80         |
| 3300                           | 383LX332M200N062       | 0.700               | 0.040  | 4.40                    | 6.20   | 40 x 63         | 2200                           | 383LX222M250B052V      | 0.098               | 0.064  | 4.35                    | 6.09   | 50 x 50         |
| 3300                           | 383LX332M200B052V      | 0.075               | 0.045  | 5.20                    | 7.28   | 50 x 50         | 2700                           | 383LX272M250N082       | 0.092               | 0.047  | 3.10                    | 4.30   | 40 x 80         |
| 3900                           | 383LX392M200B062V      | 0.064               | 0.038  | 5.90                    | 8.26   | 50 x 63         | 2700                           | 383LX272M250B062V      | 0.080               | 0.052  | 4.98                    | 6.97   | 50 x 63         |
| 4700                           | 383LX472M200N082       | 0.050               | 0.030  | 5.75                    | 8.10   | 40 x 80         | 3300                           | 383LX332M250N082       | 0.065               | 0.042  | 4.86                    | 6.80   | 40 x 80         |
| 4700                           | 383LX472M200B082V      | 0.053               | 0.032  | 6.82                    | 9.55   | 50 x 80         | 3900                           | 383LX392M250N102       | 0.055               | 0.036  | 5.61                    | 7.85   | 40 x 105        |
| 5600                           | 383LX562M200N102       | 0.041               | 0.025  | 6.76                    | 9.46   | 40 x 105        | 3900                           | 383LX392M250B082V      | 0.055               | 0.036  | 6.10                    | 8.54   | 50 x 80         |
| 5600                           | 383LX562M200B092V      | 0.044               | 0.027  | 7.68                    | 10.75  | 50 x 92         | 4300                           | 383LX432M250B092V      | 0.050               | 0.033  | 6.67                    | 9.34   | 50 x 92         |
| 6800                           | 383LX682M200B102V      | 0.034               | 0.020  | 8.71                    | 12.19  | 50 x 105        | 4700                           | 383LX472M250B102V      | 0.046               | 0.030  | 7.03                    | 9.84   | 50 x 105        |
| <b>250 Vdc (300 Vdc Surge)</b> |                        |                     |        |                         |        |                 | <b>315 Vdc (365 Vdc Surge)</b> |                        |                     |        |                         |        |                 |
| 68                             | 381LX680M250H202       | 2.926               | 1.493  | 0.40                    | 0.60   | 22 x 20         | 82                             | 381LX820M315H012       | 2.430               | 1.240  | 0.60                    | 0.90   | 22 x 25         |
| 68                             | 381LX680M250H012       | 2.440               | 1.220  | 0.40                    | 0.60   | 22 x 25         | 100                            | 381LX101M315H012       | 1.990               | 1.020  | 0.70                    | 1.00   | 22 x 25         |
| 100                            | 381LX101M250H012       | 1.660               | 0.830  | 0.55                    | 0.78   | 22 x 25         | 120                            | 381LX121M315H012       | 1.660               | 0.850  | 0.80                    | 1.10   | 22 x 25         |
| 150                            | 381LX151M250H012       | 1.327               | 0.465  | 0.79                    | 0.11   | 22 x 25         | 150                            | 381LX151M315H022       | 1.330               | 0.600  | 0.82                    | 1.15   | 22 x 30         |
| 180                            | 381LX181M250H012       | 1.106               | 0.553  | 0.88                    | 1.23   | 22 x 25         | 180                            | 381LX181M315H022       | 1.110               | 0.550  | 0.90                    | 1.25   | 22 x 30         |
| 220                            | 381LX221M250H012       | 0.905               | 0.452  | 1.00                    | 1.40   | 22 x 25         | 220                            | 381LX221M315H032       | 0.900               | 0.410  | 0.98                    | 1.37   | 22 x 35         |
| 270                            | 381LX271M250H022       | 0.737               | 0.332  | 1.18                    | 1.69   | 22 x 30         | 220                            | 381LX221M315K022       | 0.904               | 0.461  | 1.00                    | 1.40   | 30 x 30         |
| 330                            | 381LX331M250H022       | 0.502               | 0.251  | 1.20                    | 1.70   | 22 x 30         | 270                            | 381LX271M315J032       | 0.740               | 0.330  | 1.10                    | 1.54   | 25 x 35         |
| 330                            | 381LX331M250J022       | 0.502               | 0.251  | 1.20                    | 1.70   | 25 x 30         | 270                            | 381LX271M315K022       | 0.737               | 0.376  | 1.10                    | 1.50   | 30 x 30         |
| 330                            | 381LX331M250J032       | 0.502               | 0.251  | 1.20                    | 1.70   | 25 x 30         | 270                            | 381LX271M315K032       | 0.737               | 0.376  | 1.10                    | 1.50   | 30 x 35         |
| 390                            | 381LX391M250J032       | 0.510               | 0.229  | 1.49                    | 2.12   | 25 x 35         | 270                            | 381LX271M315A022       | 0.737               | 0.376  | 1.10                    | 1.50   | 35 x 30         |
| 470                            | 381LX471M250J032       | 0.423               | 0.191  | 1.40                    | 1.96   | 25 x 35         | 330                            | 381LX331M315J042       | 0.600               | 0.270  | 1.20                    | 1.68   | 25 x 40         |
| 470                            | 381LX471M250K022       | 0.353               | 0.176  | 1.40                    | 2.00   | 30 x 30         | 330                            | 381LX331M315K032       | 0.603               | 0.308  | 1.20                    | 1.70   | 30 x 35         |
| 560                            | 381LX561M250J032       | 0.355               | 0.160  | 1.80                    | 2.57   | 25 x 35         | 330                            | 381LX331M315K042       | 0.603               | 0.308  | 1.20                    | 1.70   | 30 x 40         |
| 560                            | 381LX561M250K032       | 0.296               | 0.148  | 1.50                    | 2.10   | 30 x 35         | 330                            | 381LX331M315A022       | 0.603               | 0.308  | 1.20                    | 1.70   | 35 x 30         |
| 560                            | 381LX561M250A012       | 0.296               | 0.148  | 1.50                    | 2.10   | 35 x 25         | 390                            | 381LX391M315K452       | 0.510               | 0.260  | 1.30                    | 1.80   | 30 x 45         |
| 680                            | 381LX681M250J052       | 0.244               | 0.134  | 1.70                    | 2.38   | 25 x 50         | 390                            | 381LX391M315A032       | 0.510               | 0.260  | 1.30                    | 1.80   | 35 x 35         |
| 680                            | 381LX681M250K042       | 0.244               | 0.134  | 1.70                    | 2.38   | 30 x 40         | 470                            | 381LX471M315K452       | 0.423               | 0.216  | 1.40                    | 2.00   | 30 x 45         |
| 680                            | 381LX681M250A022       | 0.244               | 0.134  | 1.70                    | 2.38   | 35 x 30         | 470                            | 381LX471M315K052       | 0.423               | 0.216  | 1.40                    | 2.00   | 30 x 50         |
| 820                            | 381LX821M250K452       | 0.202               | 0.111  | 2.00                    | 2.80   | 30 x 45         | 470                            | 381LX471M315A032       | 0.423               | 0.216  | 1.40                    | 2.00   | 35 x 35         |
| 820                            | 381LX821M250A032       | 0.202               | 0.111  | 2.00                    | 2.80   | 35 x 35         | 470                            | 381LX471M315A042       | 0.423               | 0.216  | 1.40                    | 2.00   | 35 x 40         |
| 1000                           | 381LX102M250K052       | 0.199               | 0.109  | 2.20                    | 3.10   | 30 x 50         | 560                            | 381LX561M315K052       | 0.355               | 0.181  | 1.50                    | 2.10   | 30 x 50         |
| 1000                           | 381LX102M250A042       | 0.199               | 0.109  | 2.20                    | 3.10   | 35 x 40         | 560                            | 381LX561M315A042       | 0.355               | 0.181  | 1.50                    | 2.10   | 35 x 40         |
| 1000                           | 381LX102M250A452       | 0.166               | 0.099  | 2.30                    | 3.20   | 35 x 45         | 560                            | 381LX561M315A452       | 0.355               | 0.181  | 1.50                    | 2.10   | 35 x 45         |
| 1200                           | 381LX122M250A452       | 0.166               | 0.099  | 2.30                    | 3.20   | 35 x 45         | 680                            | 381LX681M315A452       | 0.293               | 0.149  | 1.70                    | 2.40   | 35 x 45         |
| 1200                           | 383LX122M250N042       | 0.180               | 0.117  | 2.66                    | 3.72   | 40 x 40         | 680                            | 381LX681M315A052       | 0.293               | 0.149  | 1.70                    | 2.40   | 35 x 50         |
| 1200                           | 383L122M250N052        | 0.081               | 0.031  | 2.60                    | 4.30   | 40 x 50         | 820                            | 381LX821M315A052       | 0.242               | 0.030  | 2.00                    | 2.80   | 35 x 50         |
| 1500                           | 381LX152M250A052       | 0.144               | 0.093  | 2.50                    | 3.50   | 35 x 50         | 820                            | 383L821M315N052        | 0.190               | 0.130  | 1.70                    | 2.10   | 40 x 50         |
| 1800                           | 383LX182M250N052       | 0.120               | 0.078  | 3.25                    | 4.55   | 40 x 50         | 1200                           | 383L122M315N062        | 0.150               | 0.110  | 2.10                    | 2.50   | 40 x 63         |
|                                |                        |                     |        |                         |        |                 | 1500                           | 383L152M315N082        | 0.110               | 0.055  | 2.70                    | 3.20   | 40 x 80         |



# Type 381LX / 383LX 105 °C High Ripple, Snap-In Aluminum

High Ripple, Long Life, 2,4 and 5 pin styles available

| Cap.<br>(µF)                   | Catalog<br>Part Number | Max. ESR         |                  | Ripple Amps   |               | Nominal       |
|--------------------------------|------------------------|------------------|------------------|---------------|---------------|---------------|
|                                |                        | @ +25°C          |                  | @ +105°C      |               | Size          |
|                                |                        | 120 Hz<br>(ohms) | 20 kHz<br>(ohms) | 120 Hz<br>(A) | 20 kHz<br>(A) | D x L<br>(mm) |
| <b>350 Vdc (400 Vdc Surge)</b> |                        |                  |                  |               |               |               |
| 82                             | 381LX820M350H012       | 2.430            | 1.240            | 0.60          | 0.90          | 22 x 25       |
| 100                            | 381LX101M350H022       | 1.990            | 1.020            | 0.70          | 1.00          | 22 x 30       |
| 120                            | 381LX121M350H022       | 1.660            | 0.750            | 0.75          | 1.05          | 22 x 30       |
| 150                            | 381LX151M350H022       | 1.330            | 0.600            | 0.77          | 1.08          | 22 x 30       |
| 180                            | 381LX181M350H032       | 1.110            | 0.500            | 0.87          | 1.22          | 22 x 35       |
| 220                            | 381LX221M350H042       | 0.900            | 0.410            | 1.00          | 1.40          | 22 x 40       |
| 270                            | 381LX271M350H452       | 0.740            | 0.380            | 1.10          | 1.50          | 22 x 45       |
| 270                            | 381LX271M350K022       | 0.737            | 0.376            | 1.10          | 1.50          | 30 x 30       |
| 330                            | 381LX331M350K042       | 0.603            | 0.308            | 1.20          | 1.70          | 30 x 40       |
| 330                            | 381LX331M350A022       | 0.603            | 0.308            | 1.20          | 1.70          | 35 x 30       |
| 390                            | 381LX391M350K452       | 0.510            | 0.260            | 1.30          | 1.80          | 30 x 45       |
| 390                            | 381LX391M350A022       | 0.510            | 0.260            | 1.30          | 1.80          | 35 x 30       |
| 470                            | 381LX471M350K052       | 0.423            | 0.216            | 1.40          | 2.00          | 30 x 50       |
| 470                            | 381LX471M350A042       | 0.423            | 0.216            | 1.40          | 2.00          | 35 x 40       |
| 560                            | 381LX561M350A452       | 0.355            | 0.181            | 1.50          | 2.10          | 35 x 45       |
| 560                            | 383L561M350N042        | 0.299            | 0.205            | 1.30          | 1.50          | 40 x 40       |
| 680                            | 381LX681M350A052       | 0.293            | 0.149            | 1.70          | 2.40          | 35 x 50       |
| 680                            | 383LX681M350N042       | 0.317            | 0.127            | 2.30          | 3.22          | 40 x 40       |
| 820                            | 381LX821M350A062       | 0.303            | 0.155            | 2.70          | 3.70          | 35 x 63       |
| 820                            | 383LX821M350N052       | 0.303            | 0.155            | 2.70          | 3.70          | 40 x 50       |
| 1000                           | 383L102M350N062        | 0.170            | 0.117            | 2.00          | 2.40          | 40 x 63       |
| 1000                           | 383LX102M350B052V      | 0.216            | 0.066            | 3.56          | 4.96          | 50 x 50       |
| 1200                           | 381LX122M350A082       | 0.207            | 0.106            | 3.20          | 4.50          | 35 x 80       |
| 1200                           | 383LX122M350N062       | 0.207            | 0.106            | 3.20          | 4.50          | 40 x 63       |
| 1500                           | 381LX152M350A102       | 0.144            | 0.057            | 4.78          | 6.69          | 35 x 105      |
| 1500                           | 383LX152M350N082       | 0.166            | 0.085            | 3.80          | 5.25          | 40 x 80       |
| 1500                           | 383LX152M350B062V      | 0.144            | 0.057            | 4.16          | 5.82          | 50 x 63       |
| 1800                           | 383LX182M350N102       | 0.120            | 0.048            | 5.23          | 7.32          | 40 x 105      |
| 1800                           | 383LX182M350B082V      | 0.120            | 0.048            | 5.69          | 7.97          | 50 x 80       |
| 2000                           | 383LX202M350B092V      | 0.108            | 0.043            | 6.34          | 8.88          | 50 x 92       |
| 2200                           | 383LX222M350B102V      | 0.098            | 0.039            | 6.60          | 9.30          | 50 x 105      |
| <b>400 Vdc (450 Vdc Surge)</b> |                        |                  |                  |               |               |               |
| 33                             | 381LX330M400H202       | 5.020            | 1.760            | 0.20          | 0.30          | 22 x 20       |
| 47                             | 381LX470M400H012       | 4.500            | 1.600            | 0.30          | 0.42          | 22 x 25       |
| 56                             | 381LX560M400H012       | 3.530            | 1.240            | 0.47          | 0.66          | 22 x 25       |
| 68                             | 381LX680M400H012       | 2.927            | 1.020            | 0.45          | 0.60          | 22 x 25       |
| 68                             | 381LX680M400J012       | 1.950            | 0.683            | 0.60          | 0.80          | 25 x 25       |
| 82                             | 381LX820M400H012       | 2.440            | 0.850            | 0.55          | 0.80          | 22 x 25       |
| 100                            | 381LX101M400H022       | 1.658            | 0.580            | 0.50          | 0.70          | 22 x 30       |
| 100                            | 381LX101M400J012       | 1.658            | 0.580            | 0.70          | 1.00          | 25 x 25       |
| 120                            | 381LX121M400J012       | 1.100            | 0.387            | 0.80          | 1.10          | 25 x 25       |
| 120                            | 381LX121M400J022       | 1.100            | 0.387            | 0.80          | 1.10          | 25 x 30       |
| <b>400 Vdc (450 Vdc Surge)</b> |                        |                  |                  |               |               |               |
| <b>420 Vdc (470 Vdc Surge)</b> |                        |                  |                  |               |               |               |
| 100                            | 381LX101M420H022       | 1.820            | 0.820            | 0.65          | 0.90          | 22 x 30       |
| 120                            | 381LX121M420H022       | 1.660            | 0.750            | 0.70          | 1.00          | 22 x 30       |
| 150                            | 381LX151M420H042       | 1.330            | 0.600            | 0.79          | 1.11          | 22 x 40       |
| 180                            | 381LX181M420H042       | 1.110            | 0.500            | 0.87          | 1.22          | 22 x 40       |
| 180                            | 381LX181M420K022       | 1.000            | 0.450            | 0.88          | 1.20          | 30 x 30       |
| 220                            | 381LX221M420H452       | 0.900            | 0.410            | 1.05          | 1.50          | 22 x 45       |
| 220                            | 381LX221M420K022       | 0.750            | 0.260            | 1.10          | 1.50          | 30 x 30       |
| 270                            | 381LX271M420J452       | 0.740            | 0.330            | 1.19          | 1.67          | 25 x 45       |
| 270                            | 381LX271M420K032       | 0.610            | 0.210            | 1.20          | 1.70          | 30 x 35       |

# Type 381LX / 383LX 105 °C High Ripple, Snap-In Aluminum

High Ripple, Long Life, 2,4 and 5 pin styles available

| Cap.<br>(µF)                   | Catalog<br>Part Number | Max. ESR         |                  | Ripple Amps   |               | Nominal       |
|--------------------------------|------------------------|------------------|------------------|---------------|---------------|---------------|
|                                |                        | @ +25°C          |                  | @ +105°C      |               | Size          |
|                                |                        | 120 Hz<br>(ohms) | 20 kHz<br>(ohms) | 120 Hz<br>(A) | 20 kHz<br>(A) | D x L<br>(mm) |
| <b>420 Vdc (470 Vdc Surge)</b> |                        |                  |                  |               |               |               |
| 270                            | 381LX271M420A022       | 0.610            | 0.210            | 1.20          | 1.70          | 35 x 30       |
| 330                            | 381LX331M420K452       | 0.500            | 0.200            | 1.35          | 1.90          | 30 x 45       |
| 330                            | 381LX331M420A032       | 0.502            | 0.200            | 1.35          | 1.90          | 35 x 35       |
| 390                            | 381LX391M420K052       | 0.420            | 0.170            | 1.55          | 2.18          | 30 x 50       |
| 390                            | 381LX391M420A042       | 0.420            | 0.170            | 1.55          | 2.18          | 35 x 40       |
| 470                            | 381LX471M420A452       | 0.350            | 0.141            | 1.75          | 2.45          | 35 x 45       |
| 470                            | 383LX471M420N042       | 0.350            | 0.141            | 1.78          | 2.45          | 40 x 40       |
| 560                            | 381LX561M420A052       | 0.300            | 0.120            | 1.80          | 2.50          | 35 x 50       |
| 680                            | 383LX681M420N052       | 0.250            | 0.100            | 2.10          | 2.95          | 40 x 50       |
| <b>450 Vdc (500 Vdc Surge)</b> |                        |                  |                  |               |               |               |
| 56                             | 381LX560M450H012       | 3.530            | 1.240            | 0.47          | 0.66          | 22 x 25       |
| 68                             | 381LX680M450H012       | 2.930            | 1.020            | 0.53          | 0.73          | 22 x 25       |
| 82                             | 381LX820M450H022       | 2.430            | 1.090            | 0.64          | 0.91          | 22 x 30       |
| 100                            | 381LX101M450H022       | 1.990            | 0.710            | 0.65          | 0.90          | 22 x 30       |
| 100                            | 381LX101M450J022       | 1.660            | 0.580            | 0.65          | 0.90          | 25 x 30       |
| 120                            | 381LX121M450H032       | 1.660            | 0.750            | 0.70          | 1.00          | 22 x 35       |
| 150                            | 381LX151M450H032       | 1.330            | 0.590            | 0.80          | 1.10          | 22 x 35       |
| 150                            | 381LX151M450K022       | 1.100            | 0.390            | 0.80          | 1.10          | 30 x 30       |
| 180                            | 381LX181M450J032       | 1.110            | 0.380            | 0.90          | 1.20          | 25 x 35       |
| 180                            | 381LX181M450K032       | 0.920            | 0.320            | 0.90          | 1.20          | 30 x 35       |
| 220                            | 381LX221M450J052       | 0.750            | 0.260            | 1.00          | 1.40          | 25 x 50       |
| 220                            | 381LX221M450K042       | 0.750            | 0.260            | 1.00          | 1.40          | 30 x 40       |
| 220                            | 381LX221M450A022       | 0.750            | 0.260            | 1.00          | 1.40          | 35 x 30       |
| 220                            | 381LX221M450A042       | 0.500            | 0.176            | 1.40          | 1.90          | 35 x 40       |
| 270                            | 381LX271M450K452       | 0.614            | 0.246            | 1.20          | 1.70          | 30 x 45       |
| 270                            | 381LX271M450A032       | 0.614            | 0.246            | 1.20          | 1.70          | 35 x 35       |
| 330                            | 381LX331M450K052       | 0.502            | 0.201            | 1.40          | 1.90          | 30 x 50       |
| 330                            | 381LX331M450A042       | 0.502            | 0.176            | 1.40          | 1.90          | 35 x 40       |
| 390                            | 381LX391M450A452       | 0.425            | 0.150            | 1.60          | 2.20          | 35 x 45       |
| 390                            | 383LX391M450N042       | 0.425            | 0.170            | 1.68          | 2.35          | 40 x 40       |
| 470                            | 381LX471M450A052       | 0.353            | 0.123            | 1.70          | 2.40          | 35 x 50       |
| 470                            | 383LX471M450N042       | 0.350            | 0.140            | 1.75          | 2.45          | 40 x 40       |
| 560                            | 381LX561M450A062       | 0.296            | 0.104            | 2.20          | 3.00          | 35 x 63       |
| 680                            | 383L681M450A082        | 0.188            | 0.124            | 2.00          | 2.50          | 35 x 80       |
| 680                            | 383LX681M450N062       | 0.244            | 0.085            | 2.50          | 3.50          | 40 x 63       |
| 680                            | 383LX681M450B052V      | 0.244            | 0.085            | 2.90          | 4.06          | 50 x 50       |
| 820                            | 383LX821M450A082       | 0.202            | 0.071            | 2.70          | 3.80          | 35 x 80       |
| 820                            | 383LX821M450B062V      | 0.222            | 0.078            | 3.42          | 4.79          | 50 x 63       |
| 1000                           | 383LX102M450N082       | 0.166            | 0.058            | 3.50          | 4.90          | 40 x 80       |
| 1200                           | 383LX122M450N102       | 0.138            | 0.048            | 4.33          | 6.06          | 40 x 105      |
| 1200                           | 383LX122M450B082V      | 0.152            | 0.053            | 4.70          | 6.58          | 50 x 80       |
| 1300                           | 383LX132M450B092V      | 0.140            | 0.049            | 5.16          | 7.25          | 50 x 92       |
| 1500                           | 383LX152M450B102V      | 0.122            | 0.043            | 6.03          | 8.44          | 50 x 105      |

**Notice and Disclaimer:** All product drawings, descriptions, specifications, statements, information and data (collectively, the "Information") in this datasheet or other publication are subject to change. The customer is responsible for checking, confirming and verifying the extent to which the Information contained in this datasheet or other publication is applicable to an order at the time the order is placed. All Information given herein is believed to be accurate and reliable, but it is presented without any guarantee, warranty, representation or responsibility of any kind, expressed or implied. Statements of suitability for certain applications are based on the knowledge that the Cornell Dubilier company providing such statements ("Cornell Dubilier") has of operating conditions that such Cornell Dubilier company regards as typical for such applications, but are not intended to constitute any guarantee, warranty or representation regarding any such matter – and Cornell Dubilier specifically and expressly disclaims any guarantee, warranty or representation concerning the suitability for a specific customer application, use, storage, transportation, or operating environment. The Information is intended for use only by customers who have the requisite experience and capability to determine the correct products for their application. Any technical advice inferred from this Information or otherwise provided by Cornell Dubilier with reference to the use of any Cornell Dubilier products is given gratis (unless otherwise specified by Cornell Dubilier), and Cornell Dubilier assumes no obligation or liability for the advice given or results obtained. Although Cornell Dubilier strives to apply the most stringent quality and safety standards regarding the design and manufacturing of its products, in light of the current state of the art, isolated component failures may still occur. Accordingly, customer applications which require a high degree of reliability or safety should employ suitable designs or other safeguards (such as installation of protective circuitry or redundancies or other appropriate protective measures) in order to ensure that the failure of an electrical component does not result in a risk of personal injury or property damage. Although all product-related warnings, cautions and notes must be observed, the customer should not assume that all safety measures are indicated in such warnings, cautions and notes, or that other safety measures may not be required.