

## 3-line IPAD™, EMI filter including ESD protection

### Features

- EMI symmetrical (I/O) low-pass filter
- High efficiency in EMI filtering
- Lead-free package
- Very low PCB space consuming: 1.2 mm<sup>2</sup>
- Very thin package: 0.60 mm
- High efficiency in ESD suppression
- High reliability offered by monolithic integration
- High reduction of parasitic elements through integration and wafer level packaging

### Complies with the following standards

- IEC 61000-4-2 Level 4 on external and V<sub>cc</sub> pins:
  - 15 kV (air discharge)
  - 8 kV (contact discharge)
- IEC 61000-4-2 Level 1 on internal pins:
  - 2 kV (air discharge)
  - 2 kV (contact discharge)
- MIL STD 883E - Method 3015-6 Class 3

### Applications

EMI filtering and ESD protection for:

- SIM Interface (subscriber identify module)
- UIM Interface (universal identify module)

### Description

The EMIF03-SIM02F3 is a highly integrated device designed to suppress EMI / RFI noise in all systems subjected to electromagnetic interferences.

This filter includes an ESD protection circuitry which prevents damage to the application when subjected to ESD surges up to 15 kV.

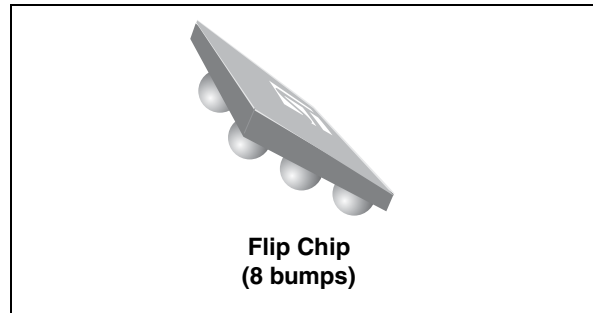

**Figure 1. Pin configuration (bump side)**

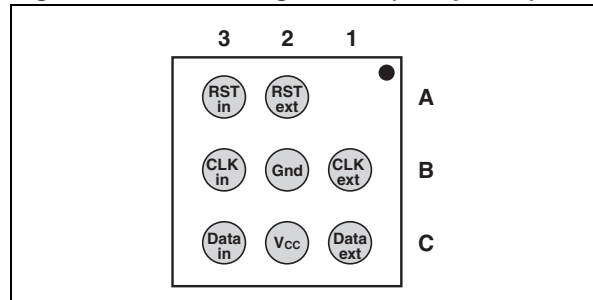

**Figure 2. Configuration**

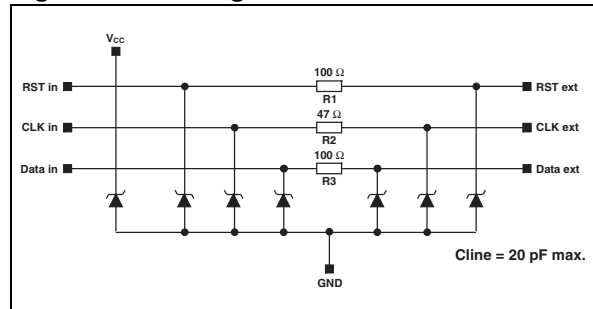

TM: IPAD is a trademark of STMicroelectronics.

# 1 Electrical characteristics

**Table 1. Absolute maximum ratings ( $T_{amb} = 25\text{ }^{\circ}\text{C}$ )**

Symbol	Parameter and test conditions	Value	Unit
$V_{PP}$	<b>Internal pins (A3, B3, C3):</b>		
	ESD discharge IEC 61000-4-2, air discharge	2	kV
	ESD discharge IEC 61000-4-2, contact discharge	2	
	<b>External pins (A2, B1, C2, C1):</b>		
	ESD discharge IEC 61000-4-2, air discharge	15	
ESD discharge IEC 61000-4-2, contact discharge	8		
$T_j$	Maximum junction temperature	125	$^{\circ}\text{C}$
$T_{op}$	Operating temperature range	-40 to +85	$^{\circ}\text{C}$
$T_{stg}$	Storage temperature range	-55 to 150	$^{\circ}\text{C}$

**Figure 3. Electrical characteristics (definitions)**

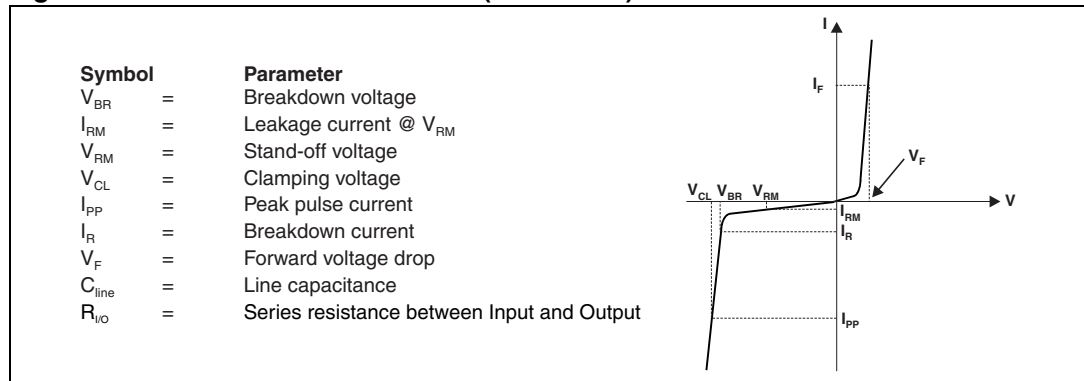

**Table 2. Electrical characteristics ( $T_{amb} = 25\text{ }^{\circ}\text{C}$ )**

Symbol	Test conditions	Min.	Typ.	Max.	Unit
$V_{BR}$	$I_R = 1\text{ mA}$	6	-	20	V
$I_{RM}$	$V_{RM} = 3\text{ V}$	-	-	0.2	$\mu\text{A}$
$R_d$		-	1.5	-	$\Omega$
$R_1, R_3$	Tolerance $\pm 20\%$	-	100	-	$\Omega$
$R_2$	Tolerance $\pm 20\%$	-	47	-	$\Omega$
$C_{line}$	$V_{line} = 0\text{ V}, V_{osc} = 30\text{ mV}, F = 1\text{ MHz}$	-	-	20	pF

Figure 4. S21 (dB) attenuation measurement (A2-A3 line)

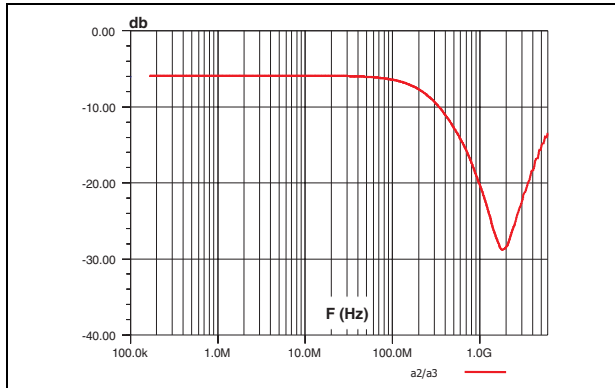

Figure 5. S21 (dB) attenuation measurement (B1-B3 line)

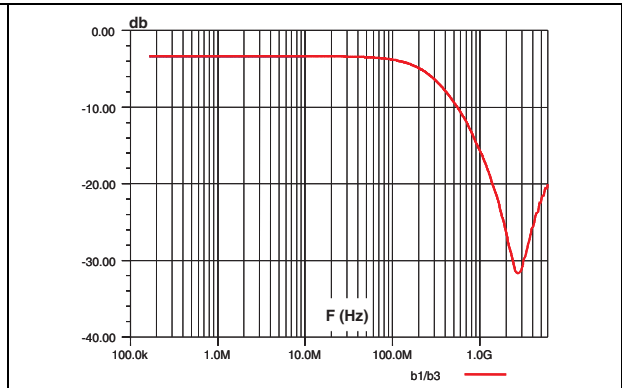

Figure 6. S21 (dB) attenuation measurement (C1-C3 line)

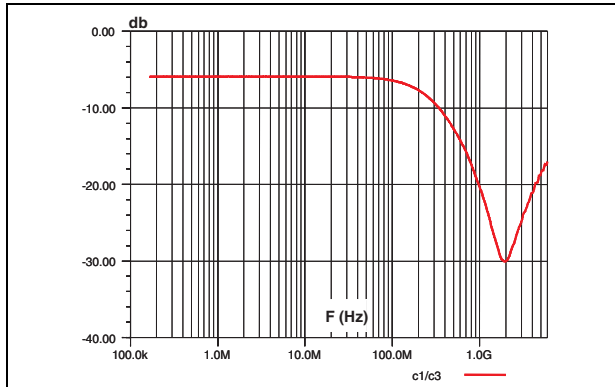

Figure 7. Analog crosstalk measurements

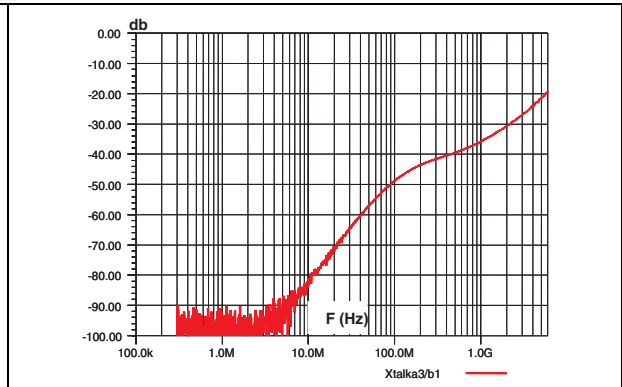

Figure 8. Digital crosstalk measurements

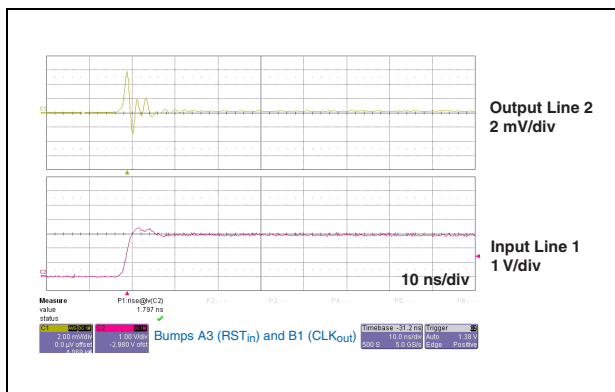
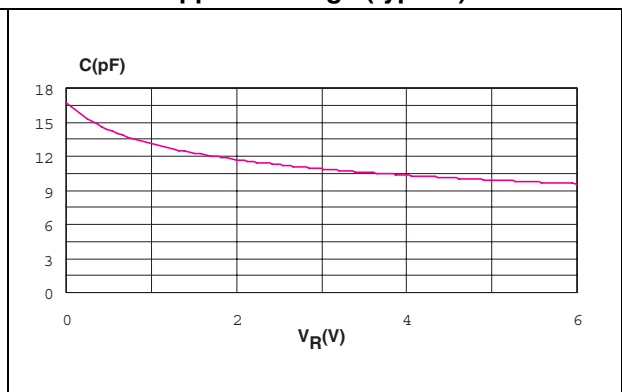

Figure 9. Line capacitance versus reverse applied voltage (typical)



## 2 Aplac model

Figure 10. Aplac model

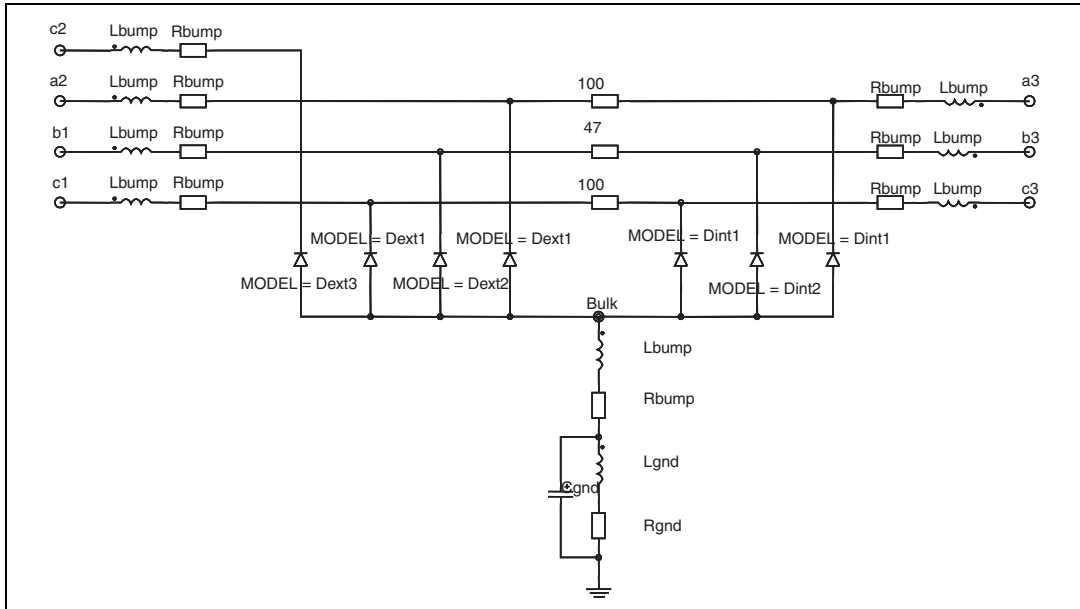

Figure 11. Aplac parameters

aplacvar Ls 950pH					
aplacvar Rs 150m	Dint1	Dext1	Dint2	Dext2	Dext3
aplacvar Cext1 12pF	BV=15	BV=15	BV=15	BV=15	BV=15
aplacvar Cext2 14pF	CJO=Cint1	CJO=Cext1	CJO=Cint2	CJO=Cext2	CJO=Cext3
aplacvar Cext3 18pF	IBV=1u	IBV=1u	IBV=1u	IBV=1u	IBV=1u
aplacvar Cint1 4.5pF	IKF=1000	IKF=1000	IKF=1000	IKF=1000	IKF=1000
aplacvar Cint2 4pF	IS=10f	IS=10f	IS=10f	IS=10f	IS=10f
aplacvar Rbump 17m	ISR=100p	ISR=100p	ISR=100p	ISR=100p	ISR=100p
aplacvar Lbump 43pH	N=1	N=1	N=1	N=1	N=1
aplacvar Rgnd 500m	M=0.3333	M=0.3333	M=0.3333	M=0.3333	M=0.3333
aplacvar Lgnd 50pH	RS=0.29	RS=0.25	RS=0.31	RS=0.28	RS=0.25
aplacvar Cgnd 0.15pF	VJ=0.6	VJ=0.6	VJ=0.6	VJ=0.6	VJ=0.6
aplacvar Rsub 100m	TT=50n	TT=50n	TT=50n	TT=50n	TT=50n

Figure 12. Voltages when IEC 61000-4-2 (+15 kV air discharge) applied to external pin

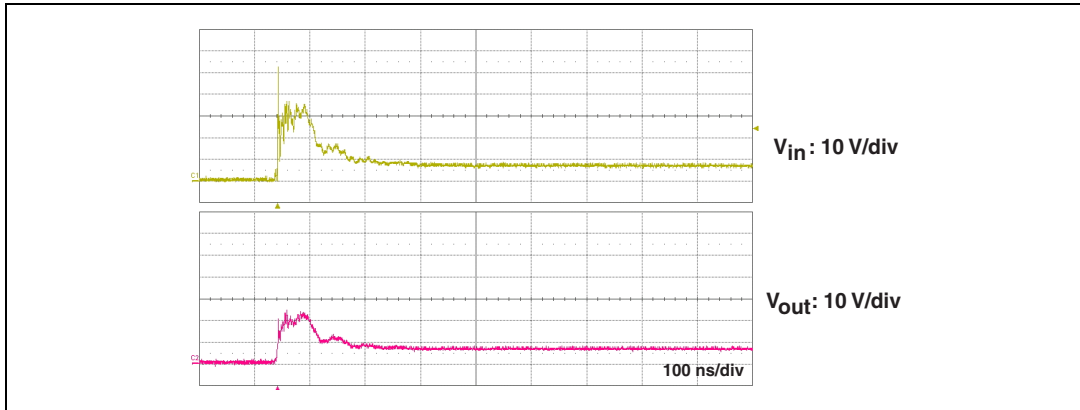
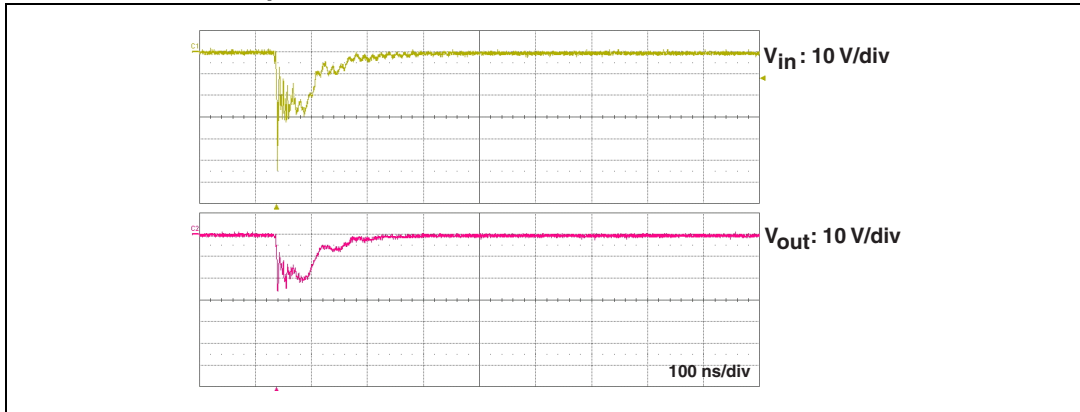
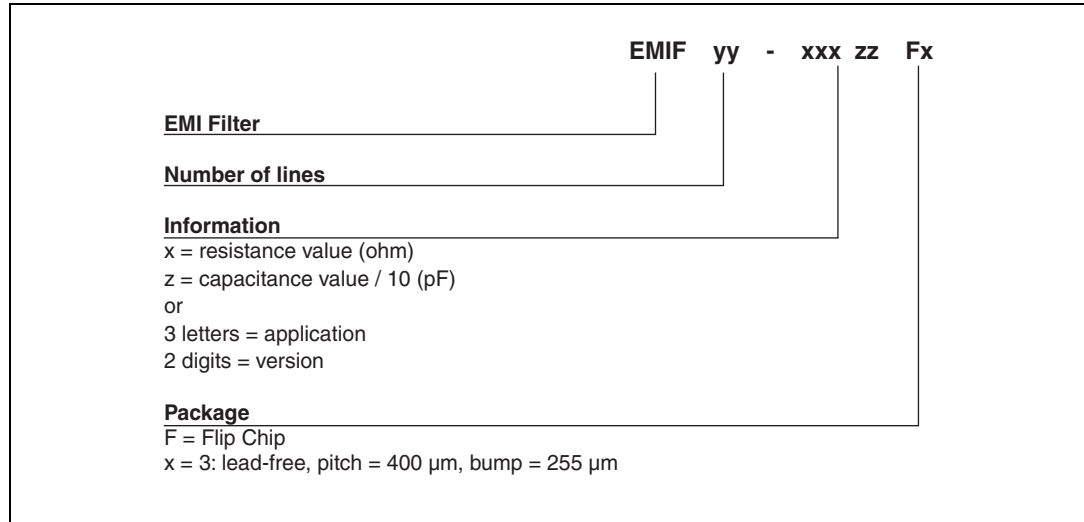

Figure 13. Voltages when IEC 61000-4-2 (- 15 kV air discharge) applied to external pin



### 3 Ordering information scheme

Figure 14. Ordering information scheme



### 4 Package information

In order to meet environmental requirements, ST offers these devices in different grades of ECOPACK® packages, depending on their level of environmental compliance. ECOPACK® specifications, grade definitions and product status are available at: [www.st.com](http://www.st.com). ECOPACK® is an ST trademark.

Figure 15. Package dimensions

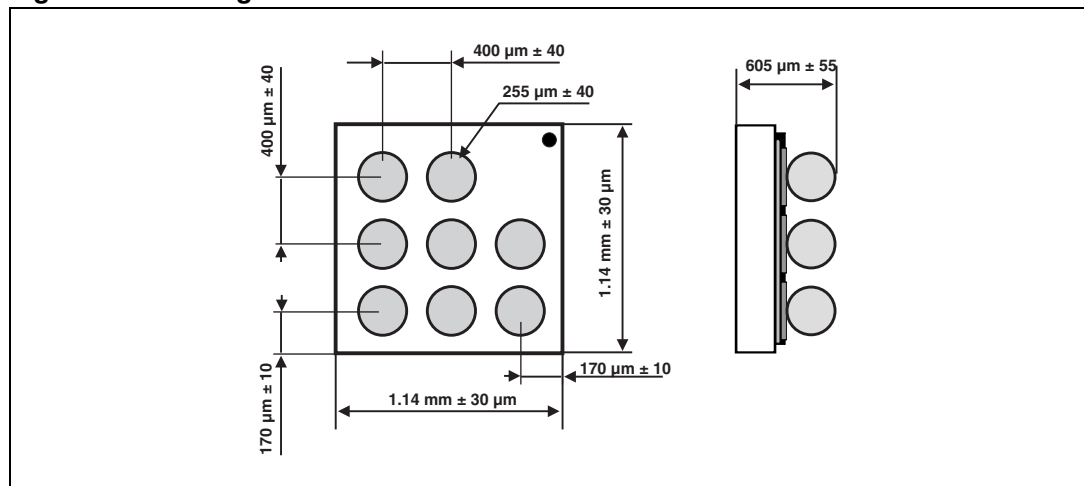

Figure 16. Footprint

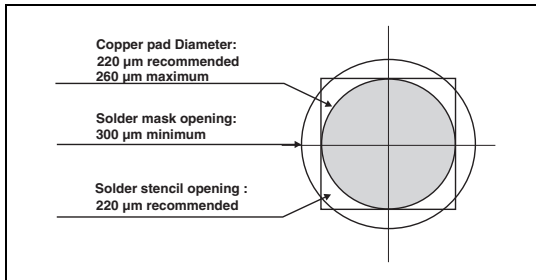

Figure 17. Marking

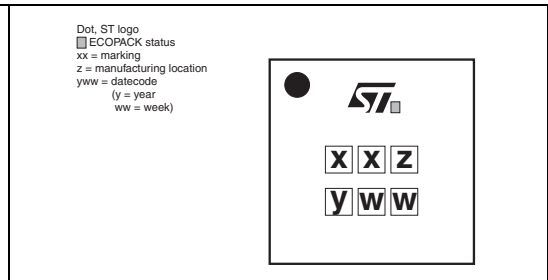
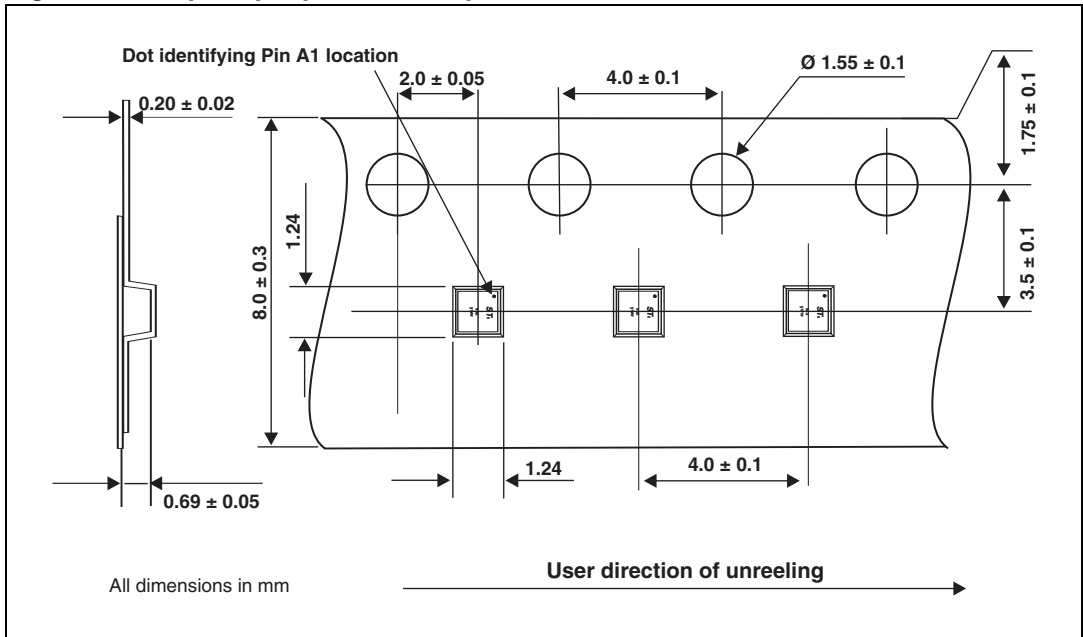

Figure 18. Flip Chip tape and reel specification



## 5 Ordering information

Table 3. Ordering information

Order code	Marking	Package	Weight	Base qty	Delivery mode
EMIF03-SIM02F3	HA	Flip Chip	1.74 mg	5000	Tape and reel 7"

Note:

More information is available in the application notes:

AN2348: "STMicroelectronics 400 micro-metre Flip Chip: package description and recommendation for use"

AN1751: "EMI filters: recommendations and measurements"

## 6 Revision history

**Table 4. Document revision history**

<b>Date</b>	<b>Revision</b>	<b>Changes</b>
19-Jul-2005	1	Initial release.
26-Feb-2007	2	Changed out to ext in Configuration diagram on page 1. Added Ecopack statement. Reformatted to current layout standard. Updated Application note AN2348 reference and description.
28-Nov-2007	3	Updated ECOPACK statement. Updated <a href="#">Figure 14</a> , <a href="#">Figure 15</a> , <a href="#">Figure 16</a> and <a href="#">Figure 18</a> . Reformatted to current standards.
09-Feb-2010	4	Updated die dimensions in <a href="#">Figure 15</a> and pocket dimensions in <a href="#">Figure 18</a> .
07-Apr-2010	5	Updated tolerance dimensions in <a href="#">Figure 15: Package dimensions</a> .



**Please Read Carefully:**

Information in this document is provided solely in connection with ST products. STMicroelectronics NV and its subsidiaries ("ST") reserve the right to make changes, corrections, modifications or improvements, to this document, and the products and services described herein at any time, without notice.

All ST products are sold pursuant to ST's terms and conditions of sale.

Purchasers are solely responsible for the choice, selection and use of the ST products and services described herein, and ST assumes no liability whatsoever relating to the choice, selection or use of the ST products and services described herein.

No license, express or implied, by estoppel or otherwise, to any intellectual property rights is granted under this document. If any part of this document refers to any third party products or services it shall not be deemed a license grant by ST for the use of such third party products or services, or any intellectual property contained therein or considered as a warranty covering the use in any manner whatsoever of such third party products or services or any intellectual property contained therein.

**UNLESS OTHERWISE SET FORTH IN ST'S TERMS AND CONDITIONS OF SALE ST DISCLAIMS ANY EXPRESS OR IMPLIED WARRANTY WITH RESPECT TO THE USE AND/OR SALE OF ST PRODUCTS INCLUDING WITHOUT LIMITATION IMPLIED WARRANTIES OF MERCHANTABILITY, FITNESS FOR A PARTICULAR PURPOSE (AND THEIR EQUIVALENTS UNDER THE LAWS OF ANY JURISDICTION), OR INFRINGEMENT OF ANY PATENT, COPYRIGHT OR OTHER INTELLECTUAL PROPERTY RIGHT.**

**UNLESS EXPRESSLY APPROVED IN WRITING BY AN AUTHORIZED ST REPRESENTATIVE, ST PRODUCTS ARE NOT RECOMMENDED, AUTHORIZED OR WARRANTED FOR USE IN MILITARY, AIR CRAFT, SPACE, LIFE SAVING, OR LIFE SUSTAINING APPLICATIONS, NOR IN PRODUCTS OR SYSTEMS WHERE FAILURE OR MALFUNCTION MAY RESULT IN PERSONAL INJURY, DEATH, OR SEVERE PROPERTY OR ENVIRONMENTAL DAMAGE. ST PRODUCTS WHICH ARE NOT SPECIFIED AS "AUTOMOTIVE GRADE" MAY ONLY BE USED IN AUTOMOTIVE APPLICATIONS AT USER'S OWN RISK.**

Resale of ST products with provisions different from the statements and/or technical features set forth in this document shall immediately void any warranty granted by ST for the ST product or service described herein and shall not create or extend in any manner whatsoever, any liability of ST.

ST and the ST logo are trademarks or registered trademarks of ST in various countries.

Information in this document supersedes and replaces all information previously supplied.

The ST logo is a registered trademark of STMicroelectronics. All other names are the property of their respective owners.

© 2010 STMicroelectronics - All rights reserved

STMicroelectronics group of companies

Australia - Belgium - Brazil - Canada - China - Czech Republic - Finland - France - Germany - Hong Kong - India - Israel - Italy - Japan - Malaysia - Malta - Morocco - Philippines - Singapore - Spain - Sweden - Switzerland - United Kingdom - United States of America

[www.st.com](http://www.st.com)

# Mouser Electronics

Authorized Distributor

Click to View Pricing, Inventory, Delivery & Lifecycle Information:

[STMicroelectronics:](#)

[EMIF03-SIM02F3](#)