

THIS DOCUMENT IS THE PROPERTY OF
KEYSTONE ELECTRONICS CORP. AND
SHALL NOT BE REPRODUCED, DISTRIBUTED
OR USED AS A BASIS FOR MANUFACTURE
WITHOUT PRIOR WRITTEN PERMISSION
FROM KEYSTONE ELECTRONICS CORP.

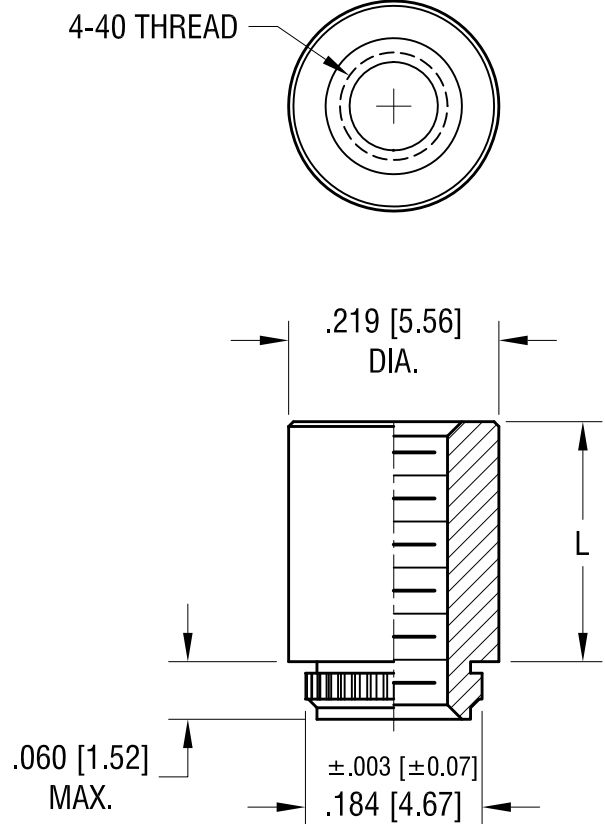

PART NO.	'L' DIM.
4861	.065 [1.65]
4862	.125 [3.18]
4863	.250 [6.35]
4864	.375 [9.53]

DATE	DESCRIPTION	REV.
1.22.13	CHANGE AS PER ECN 13-003	C
6.30.09	CHANGE AS PER ECN 09-092	B
12.19.05	CHANGE AS PER ECN 05-084	A

KEYSTONE ELECTRONICS CORP.
www.keyelco.com • ASTORIA, N.Y. 11105-2017 • Tel (718) 956-8900

PART NAME
FORCE-FIT STANDOFF, THREADED

MATERIAL
STAINLESS STEEL

FINISH NONE	DRN BY BOONE	DATE 3.14.97
	APP'D LN	SCALE 5X

TOLERANCES	INCH [MM]	CODE	DWG NO.
DECIMAL	± .005 [± 0.15]	C	4861-4864
ANGULAR	± 1°		
UNLESS OTHERWISE SPECIFIED			

Mouser Electronics

Authorized Distributor

Click to View Pricing, Inventory, Delivery & Lifecycle Information:

[Keystone Electronics:](#)

[4863](#)