

Slotted Optical Switch

OPB816Z



Features:

- 0.20" (5.1 mm) wide gap, 0.61" (15.5 mm) deep slot
- Wire length 24" (609 mm) minimum, 26 AWG
- Dust protection
- Two mounting tabs

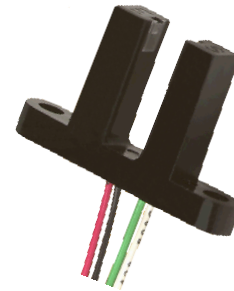

Description:

The OPB816Z slotted switch consists of an infrared emitting diode and an NPN silicon phototransistor mounted in an opaque housing with clear windows for dust protection. Switching of the phototransistor occurs whenever an opaque object passes through the slot.

The OPB816Z has an 0.61" (15.5 mm) deep slot allowing for a longer reach of the optical center line from the mounting plane. The phototransistor internal apertures are 0.010" x 0.06" (0.25 mm x 1.52 mm) on the sensor side ("S") and 0.05" x 0.06" (1.27 mm x 1.52 mm) on the emitter side ("E").

Applications:

- Non-contact object sensing
- Assembly line automation
- Machine automation
- Equipment security
- Machine safety

Ordering Information	
Part Number	Description
OPB816Z	Slotted switch

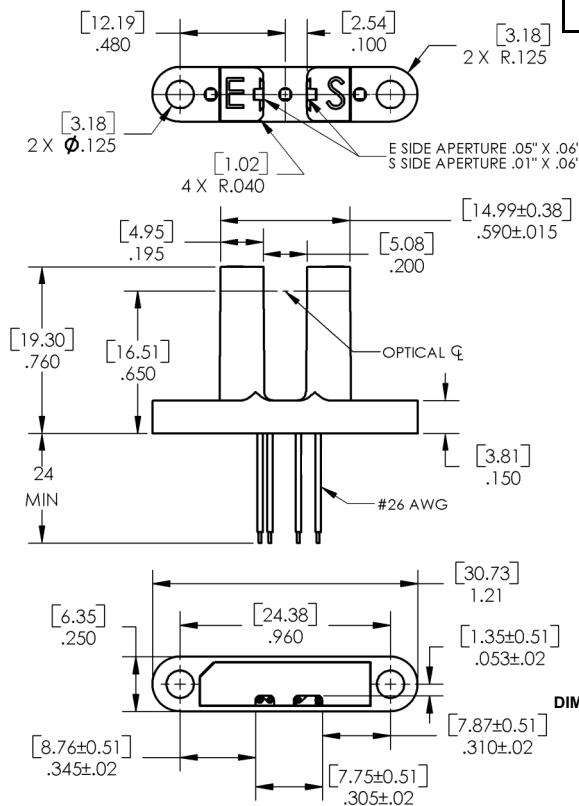
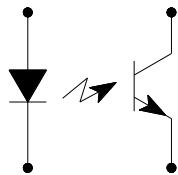

Wire Color	Description
Red	Anode
Black	Cathode
Green	Emitter
White	Collector



RoHS

DIMENSIONS ARE IN: [MILLIMETERS] INCHES

General Note

TT Electronics reserves the right to make changes in product specification without notice or liability. All information is subject to TT Electronics' own data and is considered accurate at time of going to print.

TT Electronics | Optek Technology, Inc.
1645 Wallace Drive, Ste. 130, Carrollton, TX USA 75006 | Ph: +1 972 323 2200
www.ttelectronics.com | sensors@ttelectronics.com

Electrical Specifications

Absolute Maximum Ratings ($T_A=25^\circ\text{C}$ unless otherwise noted)

Storage & Operating Temperature Range	-40°C to +85°C
Lead Soldering Temperature [1/16 inch (1.6mm) from the case for 5 sec. with soldering iron] ⁽¹⁾	260°C

Input Diode (see OP140 for additional information)

Forward DC Current	50 mA
Peak Forward Current (1 μs pulse width, 300 pps)	3 A
Reverse DC Voltage	2 V
Power Dissipation ⁽²⁾	100 mW

Output Phototransistor (See OP552 for additional information)

Collector-Emitter Voltage	30 V
Emitter-Collector Voltage	5 V
Collector DC Current	30 mA
Power Dissipation ⁽²⁾	100 mW

Electrical Characteristics ($T_A = 25^\circ\text{C}$ unless otherwise noted)

SYMBOL	PARAMETER	MIN	TYP	MAX	UNITS	TEST CONDITIONS
--------	-----------	-----	-----	-----	-------	-----------------

Input Diode (see OP140 for additional information)

V_F	Forward Voltage	-	-	1.8	V	$I_F = 20 \text{ mA}$
I_R	Reverse Current	-	-	100	μA	$V_R = 2 \text{ V}$

Output Phototransistor (see OP552 for additional information)

$V_{(BR)(CEO)}$	Collector-Emitter Breakdown Voltage	30	-	-	V	$I_C = 1 \text{ mA}, I_F = 0, E_E = 0$
$V_{(BR)(ECO)}$	Emitter-Collector Breakdown Voltage	5	-	-	V	$I_E = 100 \mu\text{A}, I_F = 0, E_E = 0$
I_{CEO}	Collector-Emitter Leakage Current	-	-	100	nA	$V_{CE} = 10 \text{ V}, I_F = 0, E_E = 0$

Coupled

$I_{C(ON)}$	On-State Collector Current	1.0	-	10.0	mA	$V_{CE} = 5 \text{ V}, I_F = 20 \text{ mA}$
$V_{CE(SAT)}$	Collector-Emitter	-	-	0.4	V	$I_C = 100 \mu\text{A}, I_F = 20 \text{ mA}$

Notes:

- (1) RMA flux is recommended. Duration can be extended to 10 seconds maximum when flow soldering.
- (2) Derate linearly 1.67 mW/°C above 25° C.
- (3) All parameters are tested using pulse techniques.
- (4) Methanol or isopropanol are recommended as cleaning agents. Plastic housing is soluble in chlorinated hydrocarbons and ketones.
- (5) Clear dust protection over emitter and sensor apertures.

General Note

TT Electronics reserves the right to make changes in product specification without notice or liability. All information is subject to TT Electronics' own data and is considered accurate at time of going to print.

TT Electronics | Optek Technology, Inc.
1645 Wallace Drive, Ste. 130, Carrollton, TX USA 75006 | Ph: +1 972 323 2200
www.ttelectronics.com | sensors@ttelectronics.com

Slotted Optical Switch

OPB816Z



Performance

OPB816Z - Flag Next to Emitter

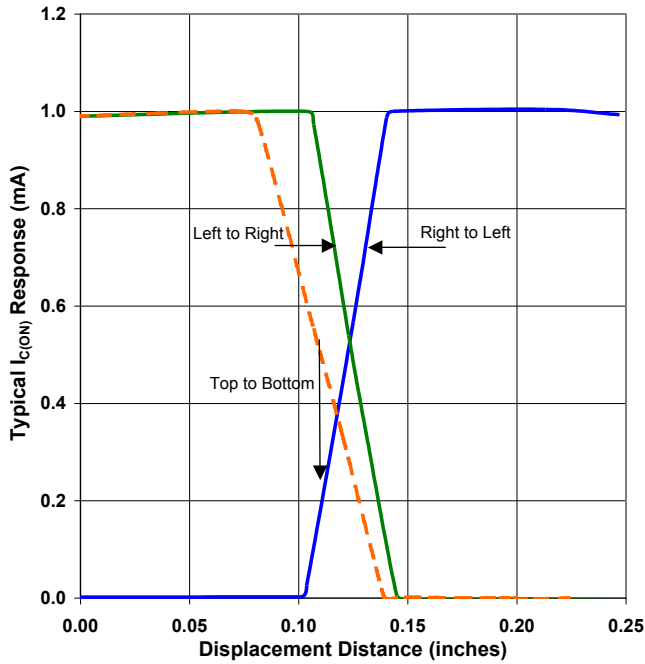

OPB816Z - Flag Next to Sensor

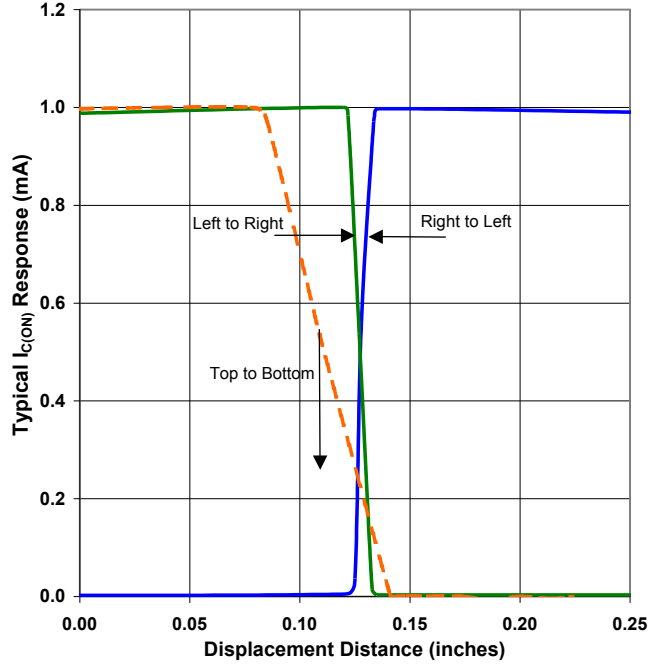

OPB816Z - Flag in Middle of Slot

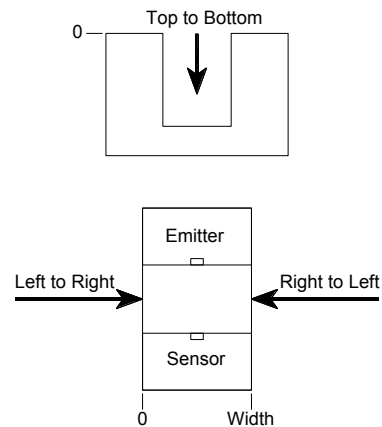
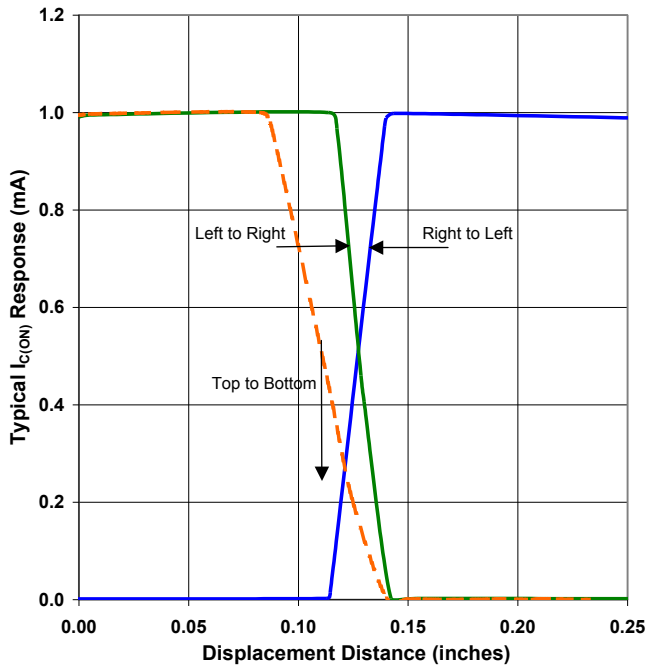

General Note

TT Electronics reserves the right to make changes in product specification without notice or liability. All information is subject to TT Electronics' own data and is considered accurate at time of going to print.

TT Electronics | Optek Technology, Inc.
1645 Wallace Drive, Ste. 130, Carrollton, TX USA 75006 | Ph: +1 972 323 2200
www.ttelectronics.com | sensors@ttelectronics.com

Mouser Electronics

Authorized Distributor

Click to View Pricing, Inventory, Delivery & Lifecycle Information:

[TT Electronics:](#)

[OPB816Z](#)