

MJH6284 (NPN), MJH6287 (PNP)

Darlington Complementary Silicon Power Transistors

These devices are designed for general-purpose amplifier and low-speed switching motor control applications.

Features

- Similar to the Popular NPN 2N6284 and the PNP 2N6287
- Rugged RBSOA Characteristics
- Monolithic Construction with Built-in Collector-Emitter Diode
- These are Pb-Free Devices*

MAXIMUM RATINGS

Rating	Symbol	Max	Unit
Collector-Emitter Voltage	V_{CEO}	100	Vdc
Collector-Base Voltage	V_{CB}	100	Vdc
Emitter-Base Voltage	V_{EB}	5.0	Vdc
Collector Current – Continuous – Peak	I_C	20 40	Adc
Base Current	I_B	0.5	Adc
Total Device Dissipation @ $T_C = 25^\circ\text{C}$ Derate above 25°C	P_D	160 1.28	W W/ $^\circ\text{C}$
Operating and Storage Junction Temperature Range	T_J, T_{stg}	-65 to +150	$^\circ\text{C}$

THERMAL CHARACTERISTICS

Characteristic	Symbol	Max	Unit
Thermal Resistance, Junction-to-Case	$R_{\theta JC}$	0.78	$^\circ\text{C}/\text{W}$

Stresses exceeding Maximum Ratings may damage the device. Maximum Ratings are stress ratings only. Functional operation above the Recommended Operating Conditions is not implied. Extended exposure to stresses above the Recommended Operating Conditions may affect device reliability.

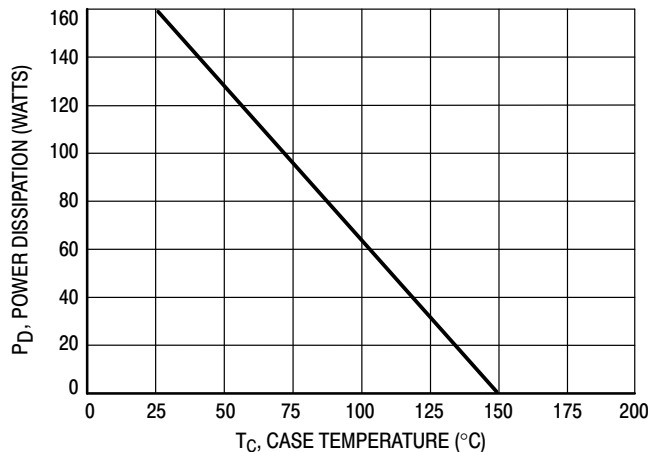

Figure 1. Power Derating

*For additional information on our Pb-Free strategy and soldering details, please download the ON Semiconductor Soldering and Mounting Techniques Reference Manual, SOLDERRM/D.



ON Semiconductor®

<http://onsemi.com>

**DARLINGTON 20 AMPERE
COMPLEMENTARY SILICON
POWER TRANSISTORS
100 VOLTS, 160 WATTS**

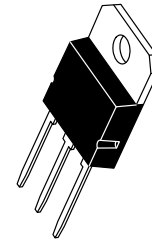

SOT-93
(TO-218)
CASE 340D

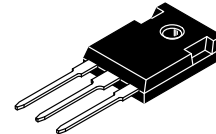

TO-247
CASE 340L
STYLE 3

NOTE: Effective June 2012 this device will be available only in the TO-247 package. Reference FPCN# 16827.

ORDERING INFORMATION

See detailed ordering and shipping information in the package dimensions section on page 2 of this data sheet.

MJH6284 (NPN), MJH6287 (PNP)

MARKING DIAGRAMS

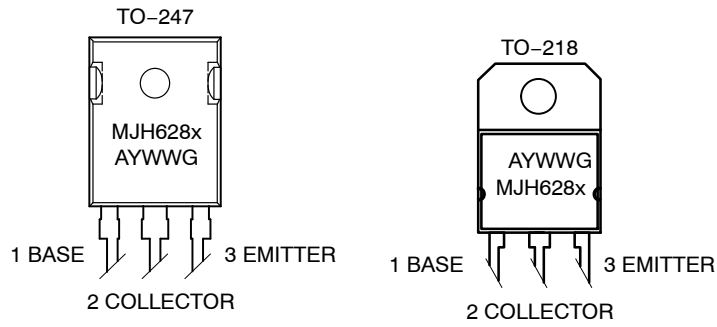

MJH628x = Device Code
 x = 4 or 7
 A = Assembly Location
 Y = Year
 WW = Work Week
 G = Pb-Free Package

ORDERING INFORMATION

Device Order Number	Package Type	Shipping
MJH6284G	TO-218 (Pb-Free)	30 Units / Rail
MJH6287G	TO-218 (Pb-Free)	30 Units / Rail
MJH6284G	TO-247 (Pb-Free)	30 Units / Rail
MJH6287G	TO-247 (Pb-Free)	30 Units / Rail

MJH6284 (NPN), MJH6287 (PNP)

ELECTRICAL CHARACTERISTICS (T_C = 25°C unless otherwise noted)

Characteristic	Symbol	Min	Max	Unit
OFF CHARACTERISTICS				
Collector-Emitter Sustaining Voltage (I _C = 0.1 Adc, I _B = 0)	V _{CEO(sus)}	100	-	Vdc
Collector Cutoff Current (V _{CE} = 50 Vdc, I _B = 0)	I _{CEO}	-	1.0	mAdc
Collector Cutoff Current (V _{CE} = Rated V _{CB} , V _{BE(off)} = 1.5 Vdc) (V _{CE} = Rated V _{CB} , V _{BE(off)} = 1.5 Vdc, T _C = 150°C)	I _{CEX}	-	0.5 5.0	mAdc
Emitter Cutoff Current (V _{BE} = 5.0 Vdc, I _C = 0)	I _{EBO}	-	2.0	mAdc

ON CHARACTERISTICS (Note 1)

DC Current Gain (I _C = 10 Adc, V _{CE} = 3.0 Vdc) (I _C = 20 Adc, V _{CE} = 3.0 Vdc)	h _{FE}	750 100	18,000 -	-
Collector-Emitter Saturation Voltage (I _C = 10 Adc, I _B = 40 mAdc) (I _C = 20 Adc, I _B = 200 mAdc)	V _{CE(sat)}	- -	2.0 3.0	Vdc
Base-Emitter On Voltage (I _C = 10 Adc, V _{CE} = 3.0 Vdc)	V _{BE(on)}	-	2.8	Vdc
Base-Emitter Saturation Voltage (I _C = 20 Adc, I _B = 200 mAdc)	V _{BE(sat)}	-	4.0	Vdc

DYNAMIC CHARACTERISTICS

Current-Gain Bandwidth Product (I _C = 10 Adc, V _{CE} = 3.0 Vdc, f = 1.0 MHz)	f _T	4.0	-	MHz
Output Capacitance (V _{CB} = 10 Vdc, I _E = 0, f = 0.1 MHz)	C _{ob}	- -	400 600	pF
				MJH6284 MJH6287
Small-Signal Current Gain (I _C = 10 Adc, V _{CE} = 3.0 Vdc, f = 1.0 kHz)	h _{fe}	300	-	-

SWITCHING CHARACTERISTICS

Resistive Load		Symbol	Typical		Unit
			NPN	PNP	
Delay Time	V _{CC} = 30 Vdc, I _C = 10 Adc I _{B1} = I _{B2} = 100 mA Duty Cycle = 1.0%	t _d	0.1	0.1	μs
Rise Time		t _r	0.3	0.3	
Storage Time		t _s	1.0	1.0	
Fall Time		t _f	3.5	2.0	

1. Pulse test: Pulse Width = 300 μs, Duty Cycle = 2.0%.

R_B & R_C VARIED TO OBTAIN DESIRED CURRENT LEVELS
D₁, MUST BE FAST RECOVERY TYPES, e.g.:
1N5825 USED ABOVE I_B ≈ 100 mA
MSD6100 USED BELOW I_B ≈ 100 mA

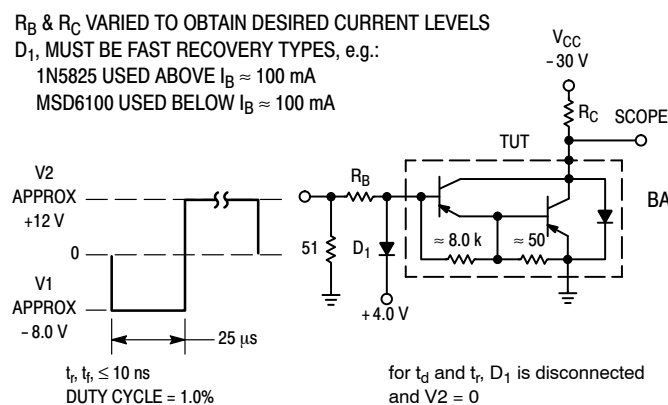

For NPN test circuit reverse diode and voltage polarities.

Figure 2. Switching Times Test Circuit

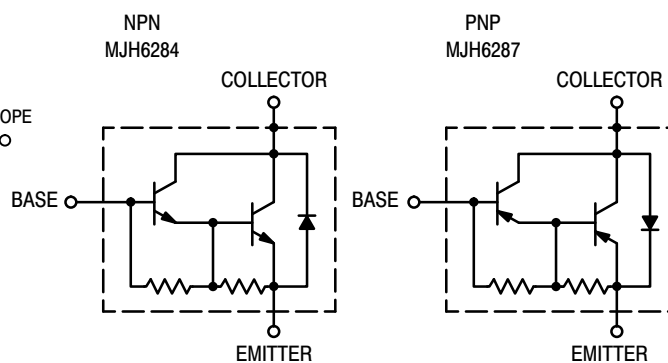

Figure 3. Darlington Schematic

MJH6284 (NPN), MJH6287 (PNP)

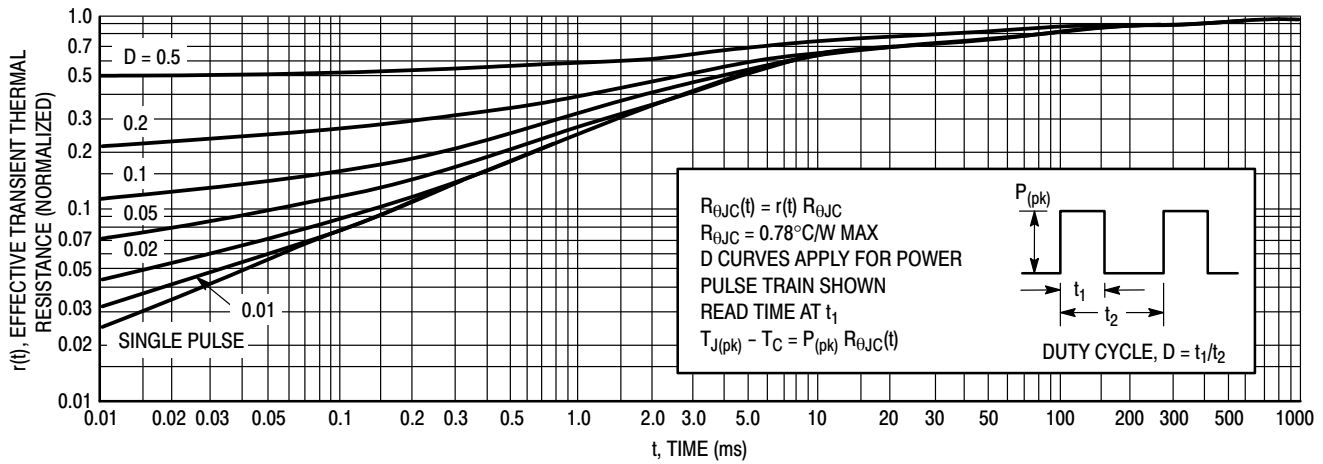

Figure 4. Thermal Response

FBSOA, FORWARD BIAS SAFE OPERATING AREA

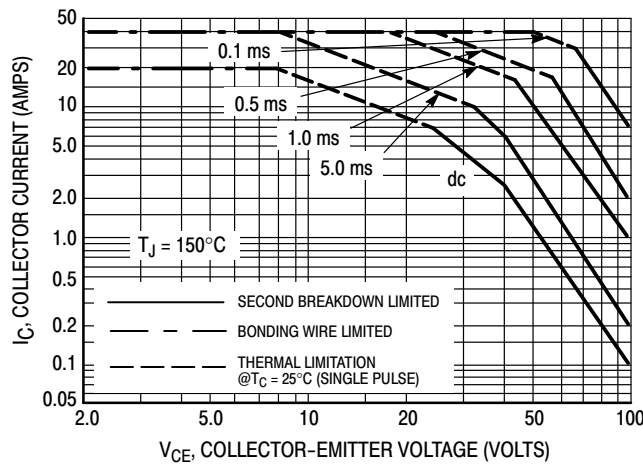

Figure 5. MJH6284, MJH6287

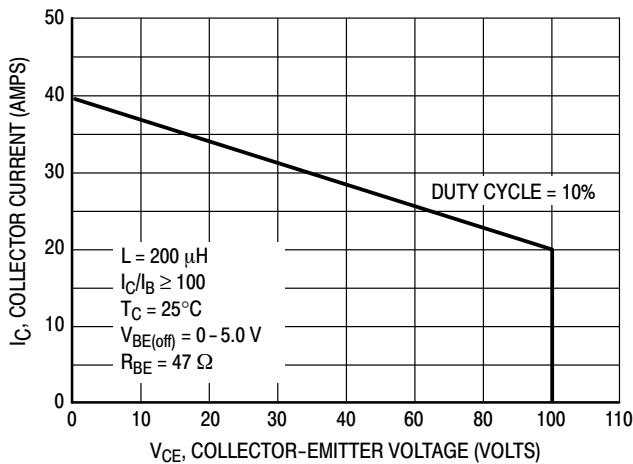

Figure 6. Maximum RBSOA, Reverse Bias Safe Operating Area

FORWARD BIAS

There are two limitations on the power handling ability of a transistor: average junction temperature and second breakdown. Safe operating area curves indicate $I_C - V_{CE}$ limits of the transistor that must be observed for reliable operation; i.e., the transistor must not be subjected to greater dissipation than the curves indicate.

The data of Figure 5 is based on $T_{J(pk)} = 150^{\circ}\text{C}$; T_C is variable depending on conditions. Second breakdown pulse limits are valid for duty cycles to 10% provided $T_{J(pk)} \leq 150^{\circ}\text{C}$. $T_{J(pk)}$ may be calculated from the data in Figure 4. At high case temperatures, thermal limitations will reduce the power that can be handled to values less than the limitations imposed by second breakdown.

MJH6284 (NPN), MJH6287 (PNP)

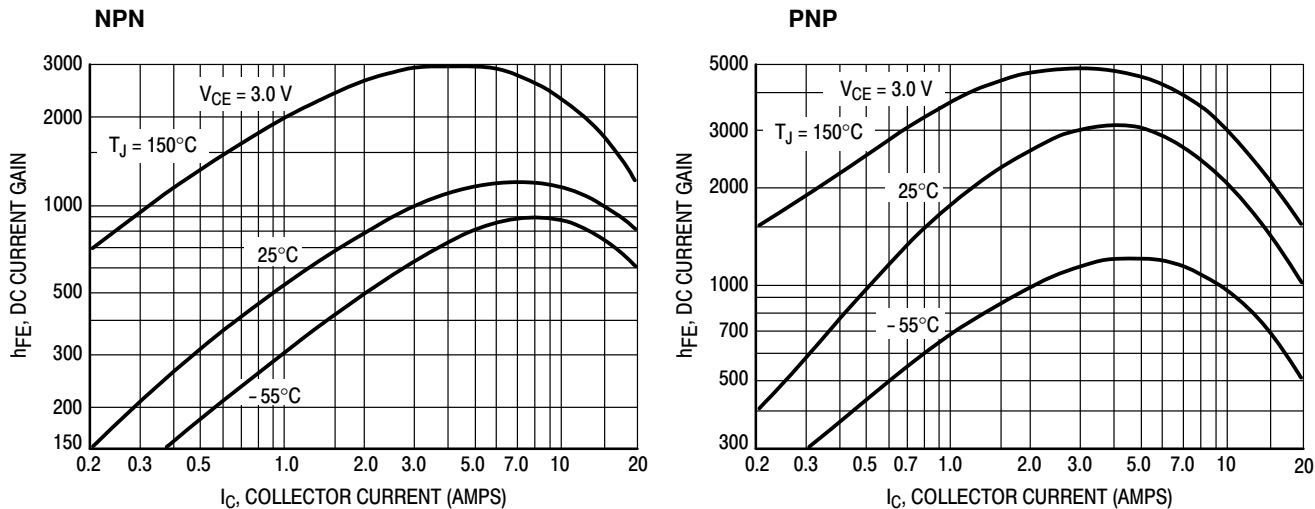

Figure 7. DC Current Gain

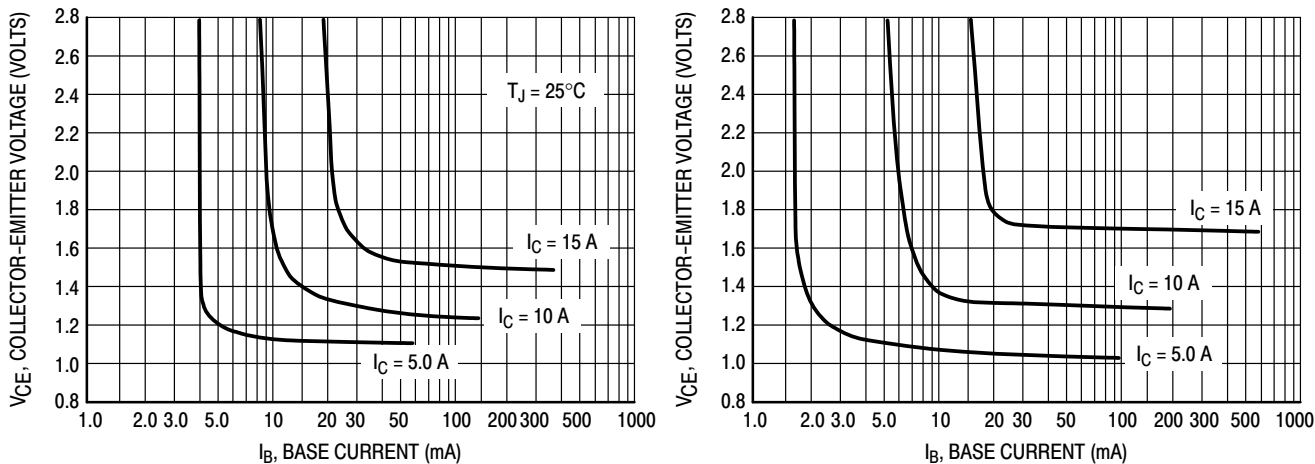

Figure 8. Collector Saturation Region

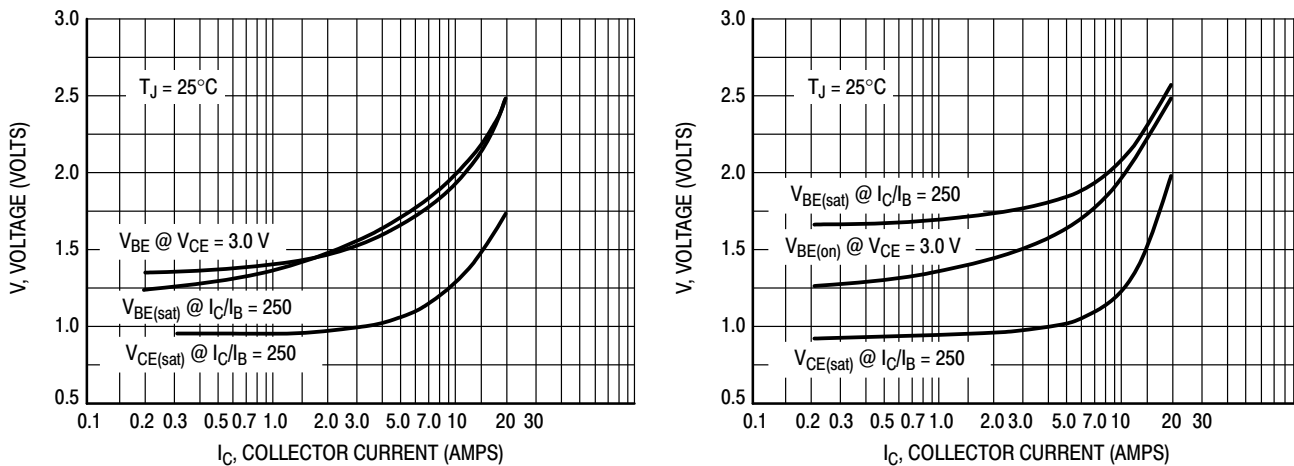

Figure 9. "On" Voltages

MJH6284 (NPN), MJH6287 (PNP)

PACKAGE DIMENSIONS

SOT-93 (TO-218)

CASE 340D-02

ISSUE E

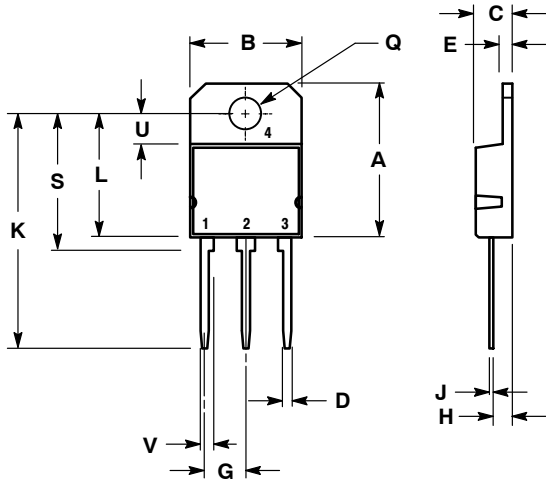

NOTES:

1. DIMENSIONING AND TOLERANCING PER ANSI Y14.5M, 1982.
2. CONTROLLING DIMENSION: MILLIMETER.

DIM	MILLIMETERS		INCHES	
	MIN	MAX	MIN	MAX
A	---	20.35	---	0.801
B	14.70	15.20	0.579	0.598
C	4.70	4.90	0.185	0.193
D	1.10	1.30	0.043	0.051
E	1.17	1.37	0.046	0.054
G	5.40	5.55	0.213	0.219
H	2.00	3.00	0.079	0.118
J	0.50	0.78	0.020	0.031
K	31.00 REF		1.220 REF	
L	---	16.20	---	0.638
Q	4.00	4.10	0.158	0.161
S	17.80	18.20	0.701	0.717
U	4.00 REF		0.157 REF	
V	1.75 REF		0.069	

STYLE 1:

- PIN 1. BASE
2. COLLECTOR
3. EMITTER
4. COLLECTOR

TO-247

CASE 340L-02

ISSUE F

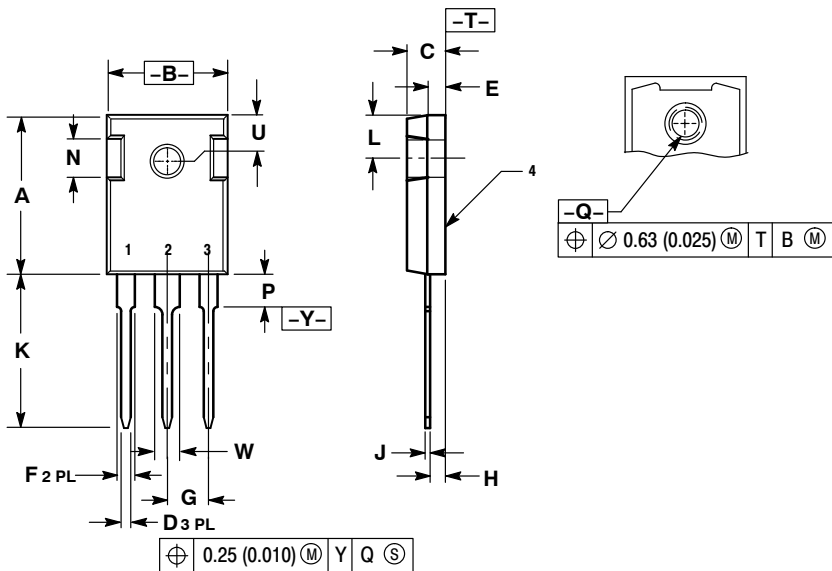

NOTES:

1. DIMENSIONING AND TOLERANCING PER ANSI Y14.5M, 1982.
2. CONTROLLING DIMENSION: MILLIMETER.

DIM	MILLIMETERS		INCHES	
	MIN	MAX	MIN	MAX
A	20.32	21.08	0.800	0.830
B	15.75	16.26	0.620	0.640
C	4.70	5.30	0.185	0.209
D	1.00	1.40	0.040	0.055
E	1.90	2.60	0.075	0.102
F	1.65	2.13	0.065	0.084
G	5.45 BSC		0.215 BSC	
H	1.50	2.49	0.059	0.098
J	0.40	0.80	0.016	0.031
K	19.81	20.83	0.780	0.820
L	5.40	6.20	0.212	0.244
N	4.32	5.49	0.170	0.216
P	---	4.50	---	0.177
Q	3.55	3.65	0.140	0.144
U	6.15 BSC		0.242 BSC	
W	2.87	3.12	0.113	0.123

STYLE 3:

- PIN 1. BASE
2. COLLECTOR
3. EMITTER
4. COLLECTOR

MJH6284 (NPN), MJH6287 (PNP)

ON Semiconductor and  are registered trademarks of Semiconductor Components Industries, LLC (SCILLC). SCILLC reserves the right to make changes without further notice to any products herein. SCILLC makes no warranty, representation or guarantee regarding the suitability of its products for any particular purpose, nor does SCILLC assume any liability arising out of the application or use of any product or circuit, and specifically disclaims any and all liability, including without limitation special, consequential or incidental damages. "Typical" parameters which may be provided in SCILLC data sheets and/or specifications can and do vary in different applications and actual performance may vary over time. All operating parameters, including "Typicals" must be validated for each customer application by customer's technical experts. SCILLC does not convey any license under its patent rights nor the rights of others. SCILLC products are not designed, intended, or authorized for use as components in systems intended for surgical implant into the body, or other applications intended to support or sustain life, or for any other application in which the failure of the SCILLC product could create a situation where personal injury or death may occur. Should Buyer purchase or use SCILLC products for any such unintended or unauthorized application, Buyer shall indemnify and hold SCILLC and its officers, employees, subsidiaries, affiliates, and distributors harmless against all claims, costs, damages, and expenses, and reasonable attorney fees arising out of, directly or indirectly, any claim of personal injury or death associated with such unintended or unauthorized use, even if such claim alleges that SCILLC was negligent regarding the design or manufacture of the part. SCILLC is an Equal Opportunity/Affirmative Action Employer. This literature is subject to all applicable copyright laws and is not for resale in any manner.

PUBLICATION ORDERING INFORMATION

LITERATURE FULFILLMENT:

Literature Distribution Center for ON Semiconductor
P.O. Box 5163, Denver, Colorado 80217 USA
Phone: 303-675-2175 or 800-344-3860 Toll Free USA/Canada
Fax: 303-675-2176 or 800-344-3867 Toll Free USA/Canada
Email: orderlit@onsemi.com

N. American Technical Support: 800-282-9855 Toll Free
USA/Canada
Europe, Middle East and Africa Technical Support:
Phone: 421 33 790 2910
Japan Customer Focus Center
Phone: 81-3-5817-1050

ON Semiconductor Website: www.onsemi.com
Order Literature: <http://www.onsemi.com/orderlit>
For additional information, please contact your local
Sales Representative

Mouser Electronics

Authorized Distributor

Click to View Pricing, Inventory, Delivery & Lifecycle Information:

[ON Semiconductor:](#)

[MJH6284](#) [MJH6287](#)