

ISL59446

500MHz Triple 4:1 Gain-of-2, Multiplexing Amplifier

FN6261
Rev 3.00
July 31, 2014

The ISL59446 is a triple channel 4:1 multiplexer featuring integrated amplifiers with a fixed gain of 2, high slew rate and excellent bandwidth for video switching. The device features a three-state output (HIZ), which allows the outputs of multiple devices to be tied together. A power-down mode (ENABLE) is included to turn off unneeded circuitry in power sensitive applications. When the ENABLE pin is pulled high, the part enters a power-down mode and consumes just 14mW.

TABLE 1. CHANNEL SELECT LOGIC TABLE ISL59446

| S1 | S0 | ENABLE | HIZ | OUTPUT |
|----|----|--------|-----|---------------|
| 0 | 0 | 0 | 0 | IN0 (A, B, C) |
| 0 | 1 | 0 | 0 | IN1 (A, B, C) |
| 1 | 0 | 0 | 0 | IN2 (A, B, C) |
| 1 | 1 | 0 | 0 | IN3 (A, B, C) |
| X | X | 1 | X | Power-Down |
| X | X | 0 | 1 | High Z |

Features

- 510MHz bandwidth into 150Ω
- ±1600V/μs slew rate
- High impedance buffered inputs
- Internally set gain-of-2
- High speed three-state outputs (HIZ)
- Power-down mode (ENABLE)
- ±5V operation
- Supply current 11mA/ch
- Pb-Free (RoHS compliant)

Applications

- HDTV/DTV analog inputs
- Video projectors
- Computer monitors
- Set-top boxes
- Security video
- Broadcast video equipment

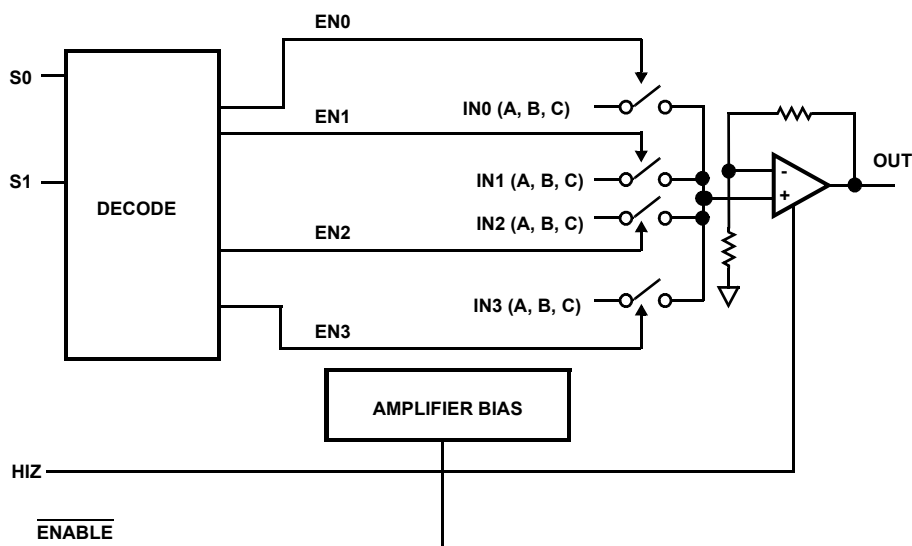

FIGURE 1. FUNCTIONAL DIAGRAM (EACH CHANNEL)

Ordering Information

| PART NUMBER (Notes 2, 3) | PART MARKING | TEMP RANGE (°C) | PACKAGE (Pb-Free) | PKG. DWG. # |
|-----------------------------|--------------|--------------------|----------------------|-------------|
| ISL59446IRZ | 59446 IRZ | -40 to +85 | 32 Ld QFN | L32.5x6A |
| ISL59446IRZ-T7 (Note 1) | 59446 IRZ | -40 to +85 | 32 Ld QFN | L32.5x6A |

NOTES:

1. Please refer to [TB347](#) for details on reel specifications.
2. These Intersil Pb-free plastic packaged products employ special Pb-free material sets, molding compounds/die attach materials, and 100% matte tin plate plus anneal (e3 termination finish, which is RoHS compliant and compatible with both SnPb and Pb-free soldering operations). Intersil Pb-free products are MSL classified at Pb-free peak reflow temperatures that meet or exceed the Pb-free requirements of IPC/JEDEC J STD-020.
3. For Moisture Sensitivity Level (MSL), please see device information page for [ISL59446](#). For more information on MSL please see tech brief [TB363](#).

Pin Configuration

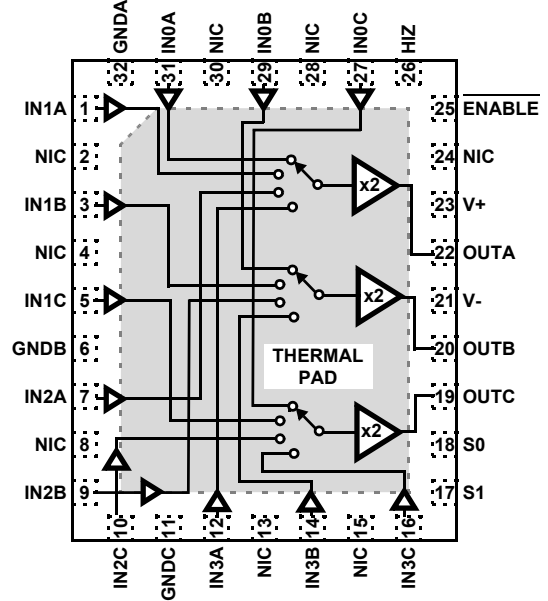

THERMAL PAD INTERNALLY CONNECTED TO V-. PAD MUST BE TIED TO V-
NIC = NO INTERNAL CONNECTION

Pin Descriptions

| ISL59446 (32 LD QFN) | PIN NAME | EQUIVALENT CIRCUIT | DESCRIPTION |
|--------------------------------|----------|-----------------------|---|
| 1 | IN1A | Circuit 1 | Channel 1 input for output amplifier "A" |
| 2, 4, 8, 13, 15, 24, 28, 30 | NIC | | Not Internally Connected; it is recommended these pins be tied to ground to minimize crosstalk. |
| 3 | IN1B | Circuit 1 | Channel 1 input for output amplifier "B" |
| 5 | IN1C | Circuit 1 | Channel 1 input for output amplifier "C" |
| 6 | GNDB | Circuit 4 | Ground pin for output amplifier "B" |
| 7 | IN2A | Circuit 1 | Channel 2 input for output amplifier "A" |
| 9 | IN2B | Circuit 1 | Channel 2 input for output amplifier "B" |
| 10 | IN2C | Circuit 1 | Channel 2 input for output amplifier "C" |
| 11 | GNDC | Circuit 4 | Ground pin for output amplifier "C" |
| 12 | IN3A | Circuit 1 | Channel 3 input for output amplifier "A" |
| 14 | IN3B | Circuit 1 | Channel 3 input for output amplifier "B" |
| 16 | IN3C | Circuit 1 | Channel 3 input for output amplifier "C" |
| 17 | S1 | Circuit 2 | Channel selection pin. MSB (binary logic code) |
| 18 | S0 | Circuit 2 | Channel selection pin. LSB (binary logic code) |
| 19 | OUTC | Circuit 3 | Output of amplifier "C" |
| 20 | OUTB | Circuit 3 | Output of amplifier "B" |
| 21 | V- | Circuit 4 | Negative power supply |
| 22 | OUTA | Circuit 3 | Output of amplifier "A" |
| 23 | V+ | Circuit 4 | Positive power supply |

Pin Descriptions (Continued)

| ISL59446 (32 LD QFN) | PIN NAME | EQUIVALENT CIRCUIT | DESCRIPTION |
|----------------------|----------------------------|--------------------|--|
| 25 | $\overline{\text{ENABLE}}$ | Circuit 2 | Device enable (active low). Internal pull-down resistor ensures device is active with no connection to this pin. A logic High puts device into power-down mode and only the logic circuitry is active. Logic states are preserved post power-down. |
| 26 | HIZ | Circuit 2 | Output disable (active high). Internal pull-down resistor ensures the device will be active with no connection to this pin. A logic high, puts the outputs in a high impedance state. Use this state to control logic when more than one MUX-amp share the same video output line. |
| 27 | INOC | Circuit 1 | Channel 0 for output amplifier "C" |
| 29 | INOB | Circuit 1 | Channel 0 for output amplifier "B" |
| 31 | INOA | Circuit 1 | Channel 0 for output amplifier "A" |
| 32 | GNDA | Circuit 4 | Ground pin for output amplifier "A" |

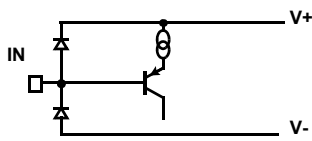

CIRCUIT 1

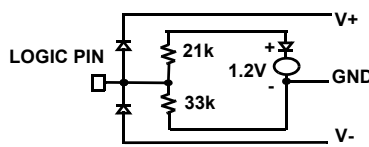

CIRCUIT 2

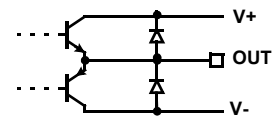

CIRCUIT 3

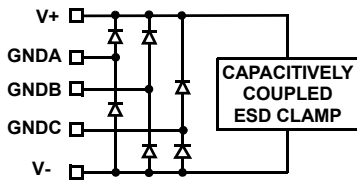

CIRCUIT 4

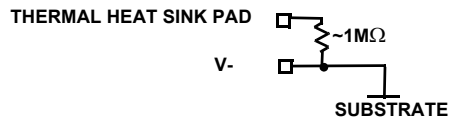

Absolute Maximum Ratings ($T_A = +25^\circ\text{C}$)

| | |
|--|--------------------|
| Supply Voltage (V+ to V-) | 11V |
| Input Voltage | V- -0.5V, V+ +0.5V |
| Supply Turn-on Slew Rate | 1V/ μs |
| Digital and Analog Input Current (Note 4) | 50mA |
| Output Current (Continuous) | 50mA |
| ESD Rating | |
| Human Body Model (Per MIL-STD-883 Method 3015.7) | 2500V |
| Machine Model | 300V |

Thermal Information

| | | |
|--------------------------------|---|---|
| Thermal Resistance (Typical) | θ_{JA} ($^\circ\text{C}/\text{W}$) | θ_{JC} ($^\circ\text{C}/\text{W}$) |
| 32 Ld QFN Package (Notes 5, 6) | 43 | 10 |
| Storage Temperature Range | -65 $^\circ\text{C}$ to +150 $^\circ\text{C}$ | |
| Ambient Operating Temperature | -40 $^\circ\text{C}$ to +85 $^\circ\text{C}$ | |
| Operating Junction Temperature | -40 $^\circ\text{C}$ to +125 $^\circ\text{C}$ | |
| Power Dissipation | See Figure 28 | |
| Pb-Free Reflow Profile | see TB493 | |

CAUTION: Do not operate at or near the maximum ratings listed for extended periods of time. Exposure to such conditions may adversely impact product reliability and result in failures not covered by warranty.

NOTES:

- If an input signal is applied before the supplies are powered up, the input current must be limited to these maximum values.
- θ_{JA} is measured in free air with the component mounted on a high effective thermal conductivity test board with "direct attach" features. See Tech Brief [TB379](#).
- For θ_{JC} , the "case temp" location is the center of the exposed metal pad on the package underside.

Electrical Specifications V+ = +5V, V- = -5V, GND = 0V, $T_A = +25^\circ\text{C}$, $V_{OUT} = \pm 2V_{P-P}$ and $R_L = 500\Omega$ to GND, $C_L = 0\text{pF}$, unless otherwise specified.

| PARAMETER | DESCRIPTION | TEST CONDITIONS | MIN (Note 7) | TYP | MAX (Note 7) | UNIT |
|-----------------------------------|------------------------------------|--|-----------------|-----------|-----------------|---------------|
| GENERAL | | | | | | |
| +I _S Enabled | Enabled Supply Current | No load, V _{IN} = 0V, Enable Low | 40 | 44 | 50 | mA |
| -I _S Enabled | Enabled Supply Current | No load, V _{IN} = 0V, Enable Low | -46 | -41 | -37 | mA |
| +I _S Disabled | Disabled Supply Current | No load, V _{IN} = 0V, Enable High | 3 | 3.4 | 4 | mA |
| -I _S Disabled | Disabled Supply Current | No load, V _{IN} = 0V, Enable High | -40 | -6 | | μA |
| V _{OUT} | Positive and Negative Output Swing | V _{IN} = $\pm 2.5\text{V}$; R _L = 500 Ω | ± 3.8 | ± 4.0 | ± 4.2 | V |
| I _{OUT} | Output Current | V _{IN} = 0.825V R _L = 10 Ω | ± 80 | ± 135 | ± 180 | mA |
| V _{OS} | Output Offset Voltage | | -40 | 0 | +40 | mV |
| I _b | Input Bias Current | V _{IN} = 0V | -4 | -2 | -1 | μA |
| R _{OUT} | HIZ Output Resistance | HIZ = Logic High | 700 | 900 | 1150 | Ω |
| R _{OUT} | Enabled Output Resistance | HIZ = Logic Low | | 0.2 | | Ω |
| R _{IN} | Input Resistance | V _{IN} = $\pm 1.75\text{V}$ | | 10 | | M Ω |
| A _{CL} or A _V | Voltage Gain | R _L = 500 Ω | 1.94 | 1.99 | 2.04 | V/V |
| LOGIC | | | | | | |
| V _{IH} | Input High Voltage (Logic Inputs) | | | 2 | | V |
| V _{IL} | Input Low Voltage (Logic Inputs) | | | 0.8 | | V |
| I _{IH} | Input High Current (Logic Inputs) | V _H = 5V | 200 | 260 | 320 | μA |
| I _{IL} | Input Low Current (Logic Inputs) | V _L = 0V | -4 | -2 | -1 | μA |
| AC GENERAL | | | | | | |
| PSRR | Power Supply Rejection Ratio | DC, PSRR V+ and V- combined V _{OUT} = 0dBm | 45 | 53 | | dB |
| Xtalk | Channel-to-Channel Crosstalk | f = 10MHz, ChX-Ch Y-Talk V _{IN} = 1V _{P-P} ; C _L = 1.1pF | | 74 | | dB |
| Off - ISO | Off-State Isolation | f = 10MHz, Ch-Ch Off Isolation V _{IN} = 1V _{P-P} ; C _L = 1.1pF | | 76 | | dB |
| dG | Differential Gain Error | NTC-7, R _L = 150, C _L = 1.1pF | | 0.008 | | % |

Electrical Specifications $V_+ = +5V$, $V_- = -5V$, $GND = 0V$, $T_A = +25^\circ C$, $V_{OUT} = \pm 2V_{P-P}$ and $R_L = 500\Omega$ to GND , $C_L = 0pF$, unless otherwise specified. (Continued)

| PARAMETER | DESCRIPTION | TEST CONDITIONS | MIN (Note 7) | TYP | MAX (Note 7) | UNIT |
|----------------------------------|---|--|-----------------|------|-----------------|-------------------|
| dP | Differential Phase Error | NTC-7, $R_L = 150\Omega$, $C_L = 1.1pF$ | | 0.01 | | ° |
| BW | Small Signal -3dB Bandwidth | $V_{OUT} = 0.2V_{P-P}$; $R_L = 500\Omega$, $C_L = 1.1pF$ | | 620 | | MHz |
| | | $V_{OUT} = 0.2V_{P-P}$; $R_L = 150\Omega$, $C_L = 2.1pF$ | | 530 | | MHz |
| | Large Signal -3dB Bandwidth | $V_{OUT} = 2V_{P-P}$; $R_L = 500\Omega$, $C_L = 1.1pF$ | | 280 | | MHz |
| | | $V_{OUT} = 2V_{P-P}$; $R_L = 150\Omega$, $C_L = 1.1pF$ | | 260 | | MHz |
| FBW | 0.1dB Bandwidth | $V_{OUT} = 2V_{P-P}$; $R_L = 500\Omega$, $C_L = 1.1pF$ | | 160 | | MHz |
| | | $V_{OUT} = 2V_{P-P}$; $R_L = 150\Omega$, $C_L = 1.1pF$ | | 50 | | MHz |
| SR | Slew Rate | 25% to 75%, $R_L = 150\Omega$, Input Enabled, $C_L = 2.1pF$ | | 1600 | | V/ μs |
| TRANSIENT RESPONSE | | | | | | |
| tr, tf Large Signal | Large Signal Rise, Fall Times, tr, tf, 10% - 90% | $V_{OUT} = 2V_{P-P}$; $R_L = 500\Omega$, $C_L = 1.1pF$ | | 1.2 | | ns |
| | | $V_{OUT} = 2V_{P-P}$; $R_L = 150\Omega$, $C_L = 2.1pF$ | | 1.3 | | ns |
| tr, tf, Small Signal | Small Signal Rise, Fall Times, tr, tf, 10% - 90% | $V_{OUT} = 0.2V_{P-P}$; $R_L = 500\Omega$, $C_L = 1.1pF$ | | 0.7 | | ns |
| | | $V_{OUT} = 0.2V_{P-P}$; $R_L = 150\Omega$, $C_L = 2.1pF$ | | 0.9 | | ns |
| ts 0.1% | Settling Time to 0.1% | $V_{OUT} = 2V_{P-P}$; $R_L = 500\Omega$, $C_L = 1.1pF$ | | 7.2 | | ns |
| | | $V_{OUT} = 2V_{P-P}$; $R_L = 150\Omega$, $C_L = 2.1pF$ | | 8.2 | | ns |
| ts 1% | Settling Time to 1% | $V_{OUT} = 2V_{P-P}$; $R_L = 500\Omega$, $C_L = 1.1pF$ | | 4 | | ns |
| | | $V_{OUT} = 2V_{P-P}$; $R_L = 150\Omega$, $C_L = 2.1pF$ | | 4.3 | | ns |
| SWITCHING CHARACTERISTICS | | | | | | |
| V _{GLITCH} | Channel - to - Channel Switching Glitch | $V_{IN} = 0V$, $R_L = 500\Omega$; $C_L = 1.1pF$ | | 90 | | mV _{P-P} |
| | | $V_{IN} = 0V$, $R_L = 150\Omega$; $C_L = 2.1pF$ | | 15 | | mV _{P-P} |
| | Enable Switching Glitch | $V_{IN} = 0V$, $R_L = 500\Omega$; $C_L = 1.1pF$ | | 1.8 | | V _{P-P} |
| | | $V_{IN} = 0V$, $R_L = 150\Omega$; $C_L = 2.1pF$ | | 1.35 | | V _{P-P} |
| | HIZ Switching Glitch | $V_{IN} = 0V$, $R_L = 500\Omega$; $C_L = 1.1pF$ | | 340 | | mV _{P-P} |
| | | $V_{IN} = 0V$, $R_L = 150\Omega$; $C_L = 2.1pF$ | | 340 | | mV _{P-P} |
| t _{SW-L-H} | Channel Switching Time Low to High | 1.2V logic threshold to 10% movement of analog output | | 24 | | ns |
| t _{SW-H-L} | Channel Switching Time High to Low | 1.2V logic threshold to 10% movement of analog output | | 24 | | ns |
| tpd | Propagation Delay | 10% to 10% | | 0.55 | | ns |

NOTE:

7. Compliance to datasheet limits is assured by one or more methods: production test, characterization and/or design.

Typical Performance Curves $V_S = \pm 5V, R_L = 500\Omega$ to GND, $T_A = +25^\circ C$, unless otherwise specified.

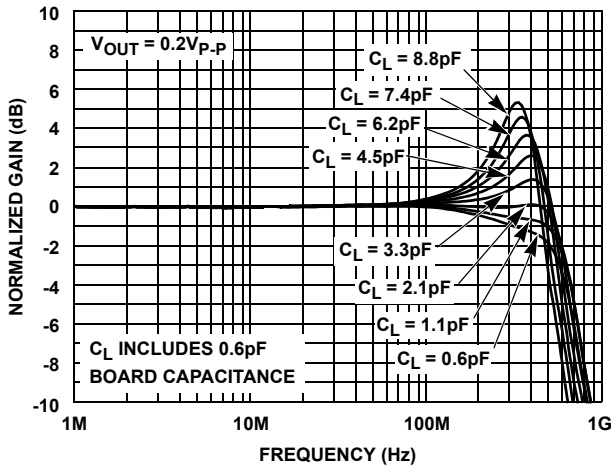

FIGURE 2. SMALL SIGNAL GAIN vs FREQUENCY vs C_L INTO 500Ω LOAD

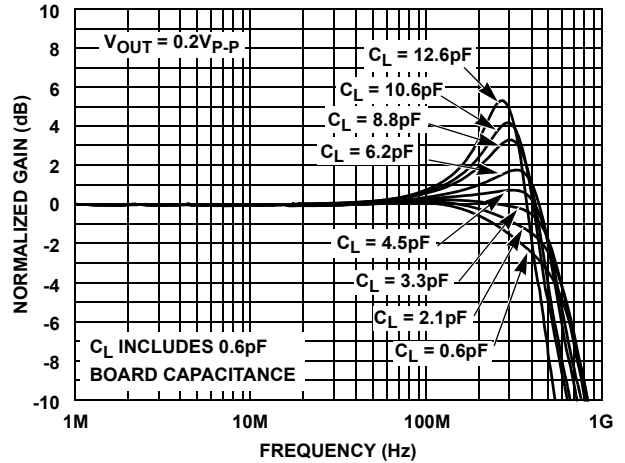

FIGURE 3. SMALL SIGNAL GAIN vs FREQUENCY vs C_L INTO 150Ω LOAD

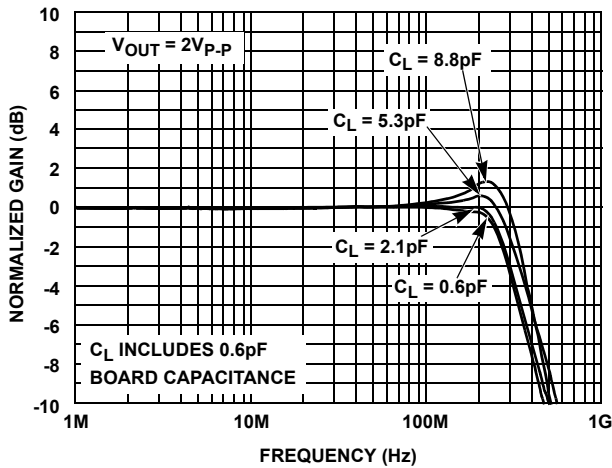

FIGURE 4. LARGE SIGNAL GAIN vs FREQUENCY vs C_L INTO 500Ω LOAD

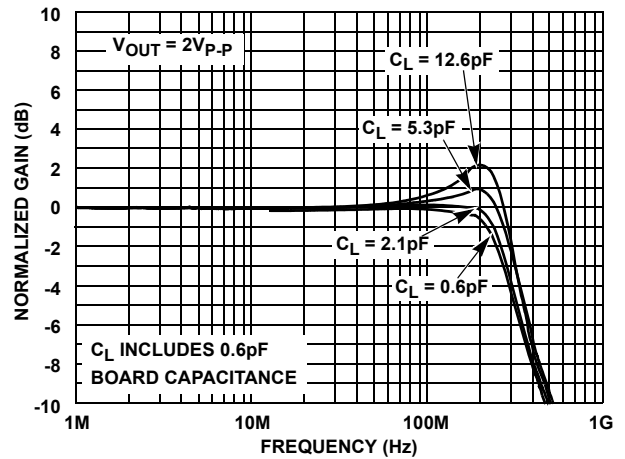

FIGURE 5. LARGE SIGNAL GAIN vs FREQUENCY vs C_L INTO 150Ω LOAD

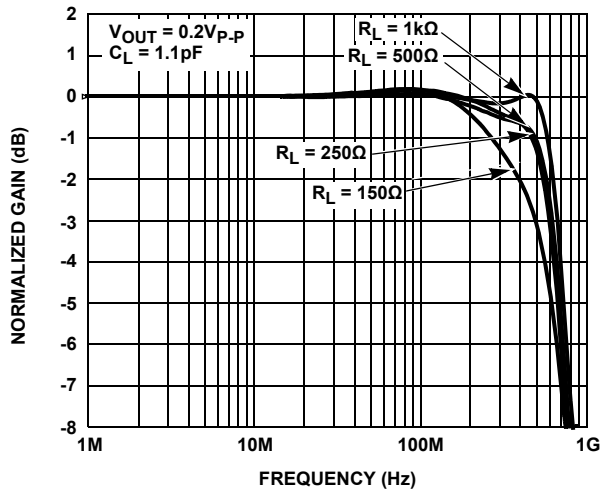

FIGURE 6. GAIN vs FREQUENCY vs R_L

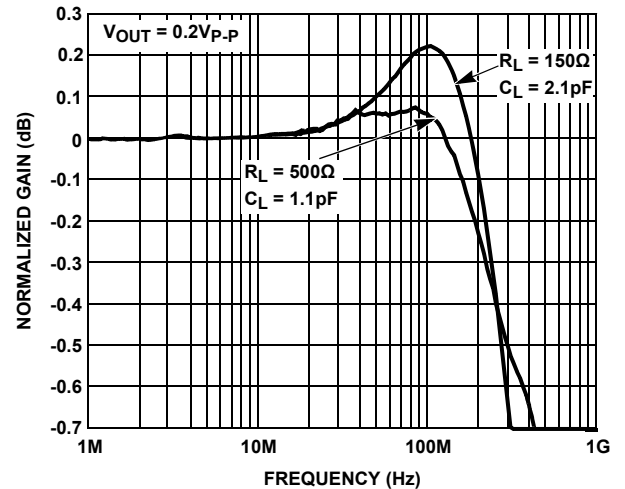

FIGURE 7. 0.1dB GAIN FLATNESS

Typical Performance Curves $V_S = \pm 5V$, $R_L = 500\Omega$ to GND, $T_A = +25^\circ C$, unless otherwise specified. (Continued)

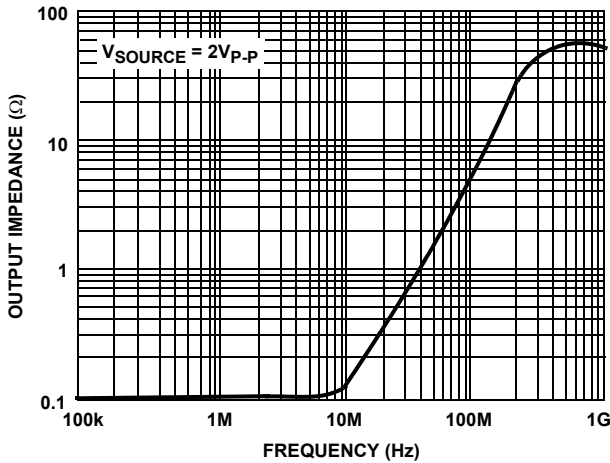

FIGURE 8. Z_{OUT} vs FREQUENCY - ENABLED

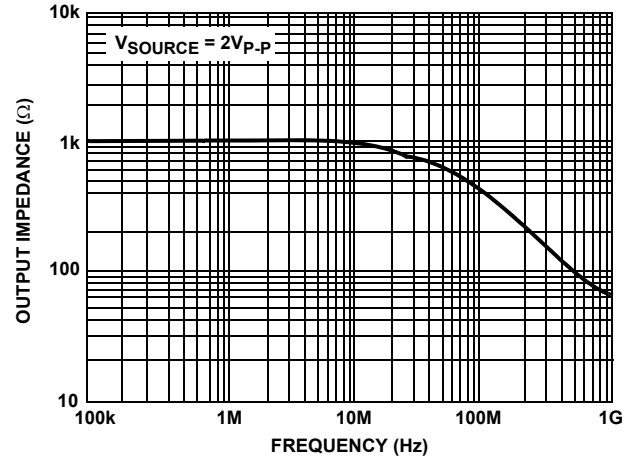

FIGURE 9. Z_{OUT} vs FREQUENCY - HIZ

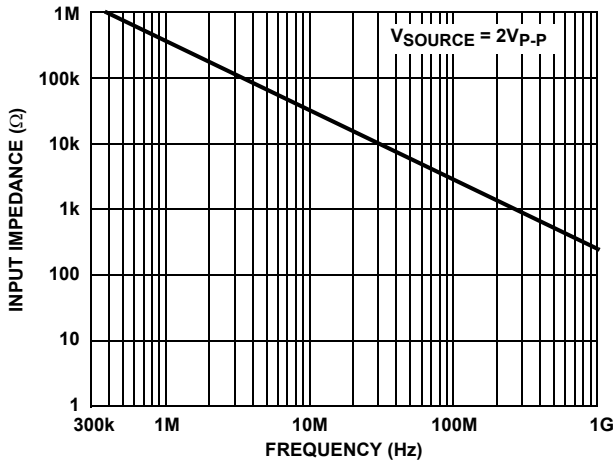

FIGURE 10. Z_{IN} vs FREQUENCY

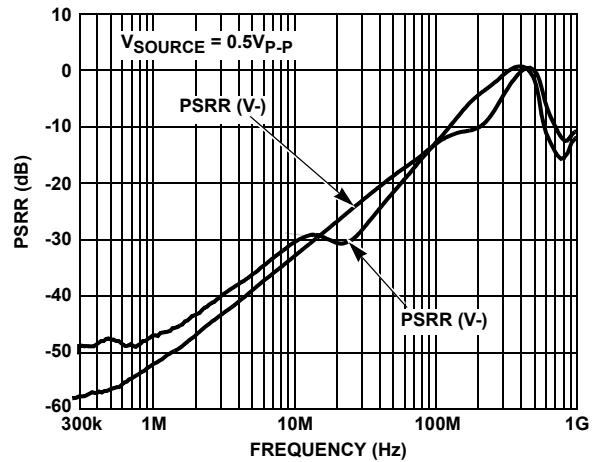

FIGURE 11. PSRR vs FREQUENCY

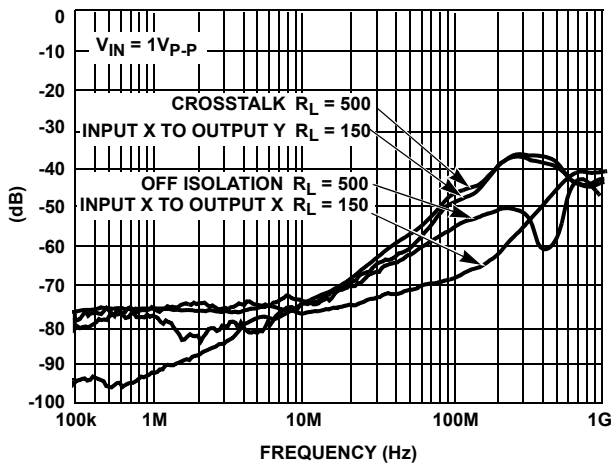

FIGURE 12. Crosstalk and Off Isolation

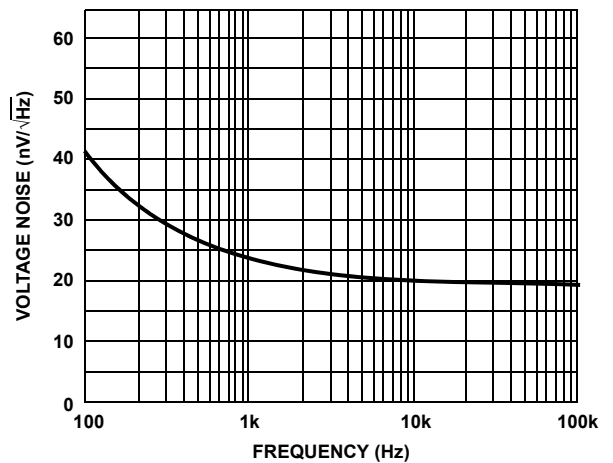

FIGURE 13. Input Noise vs Frequency

Typical Performance Curves $V_S = \pm 5V$, $R_L = 500\Omega$ to GND, $T_A = +25^\circ C$, unless otherwise specified. (Continued)

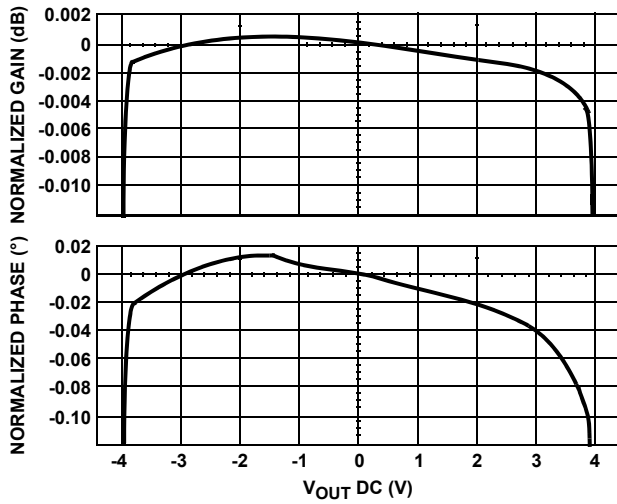

FIGURE 14. DIFFERENTIAL GAIN AND PHASE; $V_{OUT} = 0.2V_{P-P}$, $F_0 = 3.58MHz$, $R_L = 500\Omega$

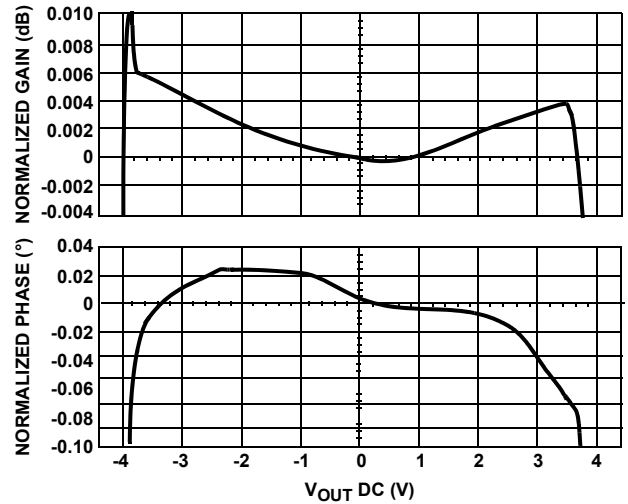

FIGURE 15. DIFFERENTIAL GAIN AND PHASE; $V_{OUT} = 0.2V_{P-P}$, $F_0 = 3.58MHz$, $R_L = 150\Omega$

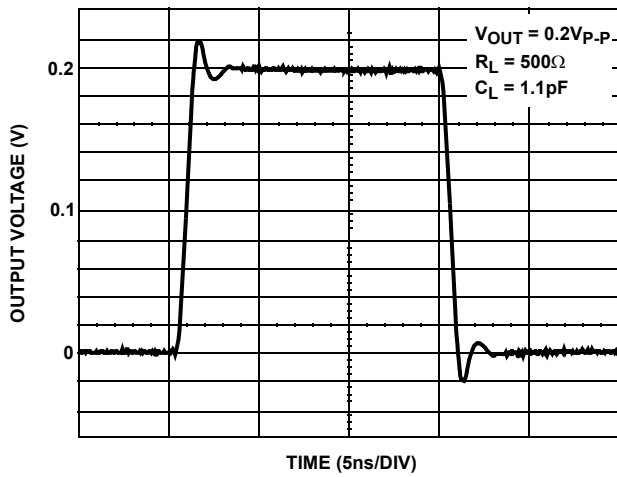

FIGURE 16. SMALL SIGNAL TRANSIENT RESPONSE; $R_L = 500\Omega$

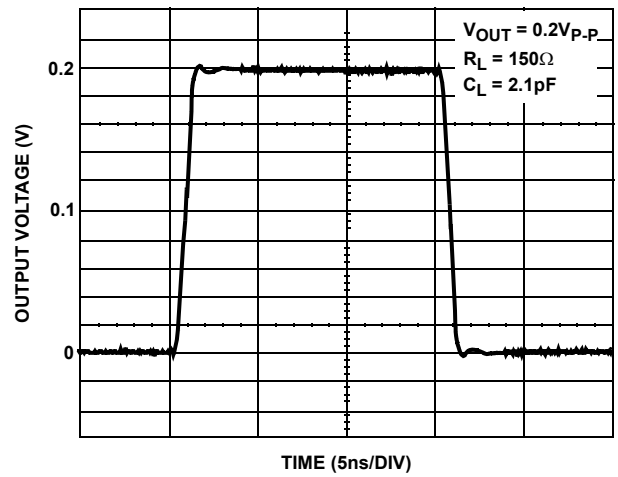

FIGURE 17. SMALL SIGNAL TRANSIENT RESPONSE; $R_L = 150\Omega$

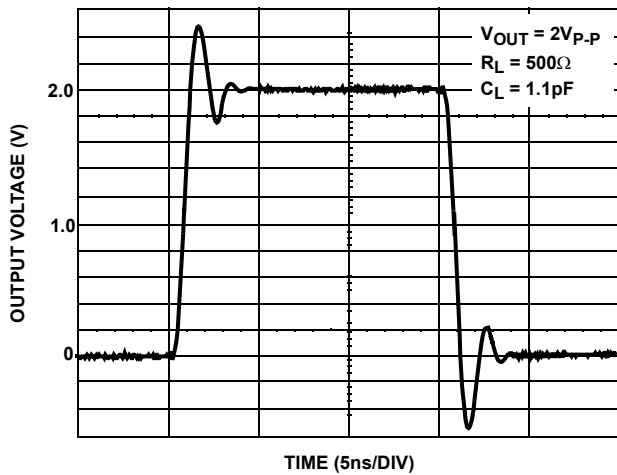

FIGURE 18. LARGE SIGNAL TRANSIENT RESPONSE; $R_L = 500\Omega$

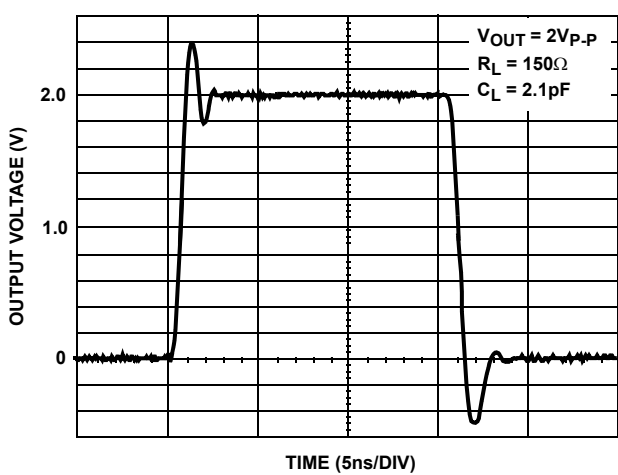

FIGURE 19. LARGE SIGNAL TRANSIENT RESPONSE; $R_L = 150\Omega$

Typical Performance Curves $V_S = \pm 5V$, $R_L = 500\Omega$ to GND, $T_A = +25^\circ C$, unless otherwise specified. (Continued)

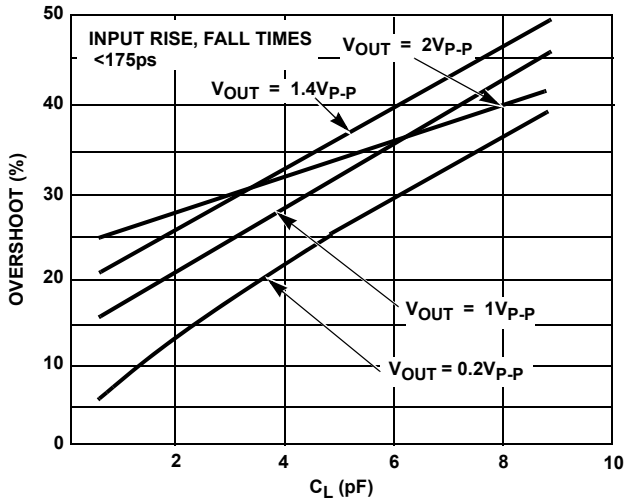

FIGURE 20. PULSE OVERSHOOT vs V_{OUT} , C_L ; $R_L = 500\Omega$

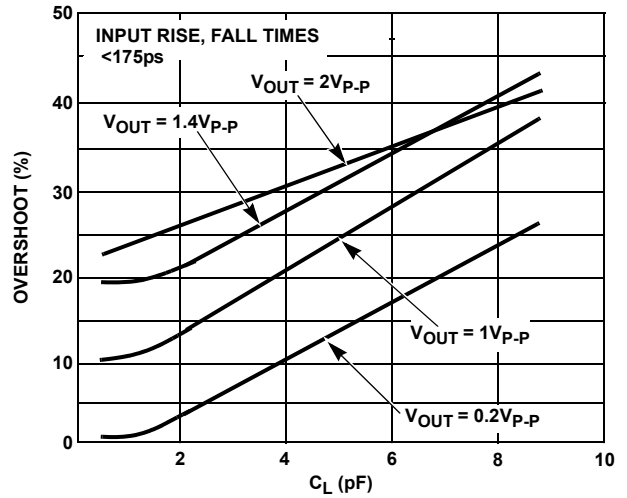

FIGURE 21. PULSE OVERSHOOT vs V_{OUT} , C_L ; $R_L = 150\Omega$

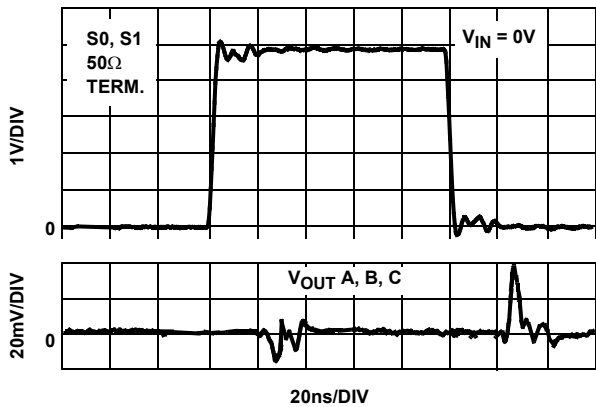

FIGURE 22. CHANNEL-TO-CHANNEL SWITCHING GLITCH $V_{IN} = 0V$

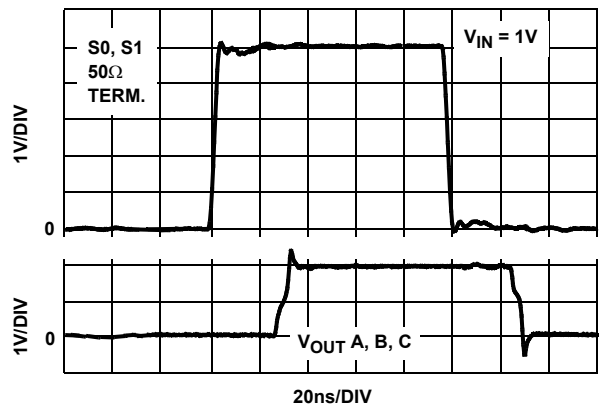

FIGURE 23. CHANNEL-TO-CHANNEL TRANSIENT RESPONSE $V_{IN} = 1V$

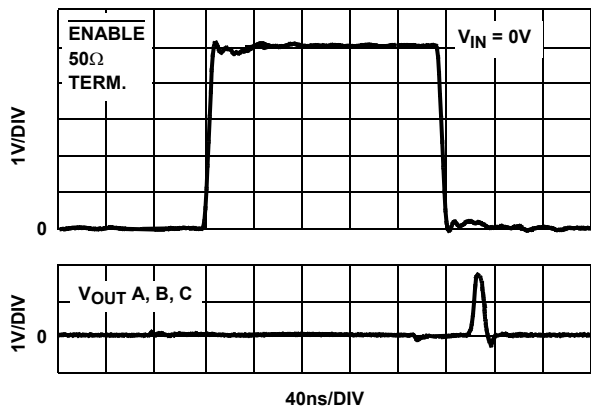

FIGURE 24. ENABLE SWITCHING GLITCH $V_{IN} = 0V$

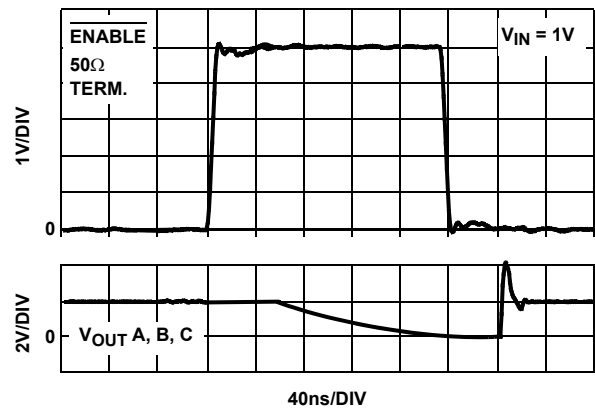

FIGURE 25. ENABLE TRANSIENT RESPONSE $V_{IN} = 1V$

Typical Performance Curves $V_S = \pm 5V$, $R_L = 500\Omega$ to GND, $T_A = +25^\circ C$, unless otherwise specified. (Continued)

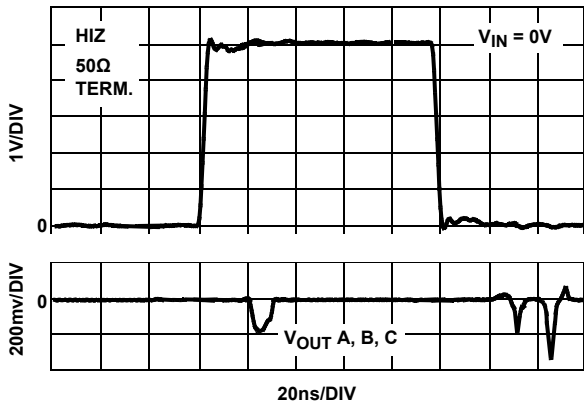

FIGURE 26. HIZ SWITCHING GLITCH $V_{IN} = 0V$

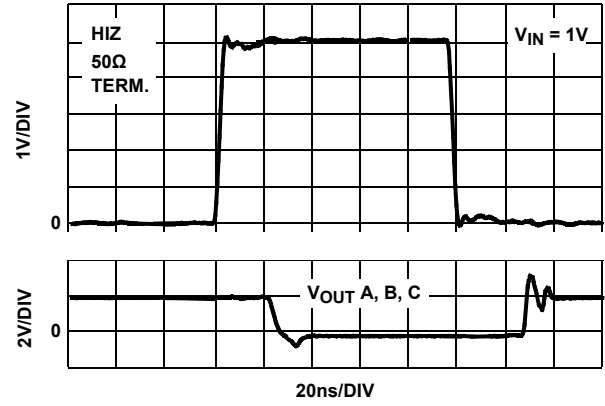

FIGURE 27. HIZ TRANSIENT RESPONSE $V_{IN} = 1V$

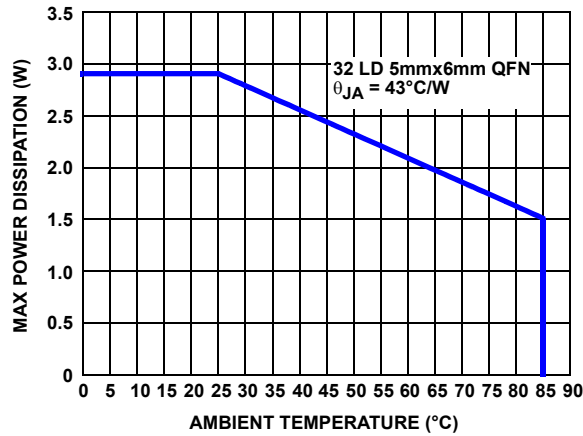

FIGURE 28. PACKAGE POWER DISSIPATION vs AMBIENT TEMPERATURE

AC Test Circuits

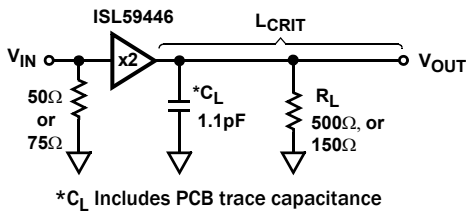

FIGURE 29A. TEST CIRCUIT WITH OPTIMAL OUTPUT LOAD

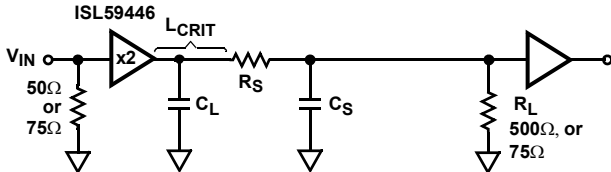

FIGURE 29B. INTER-STAGE APPLICATION CIRCUIT

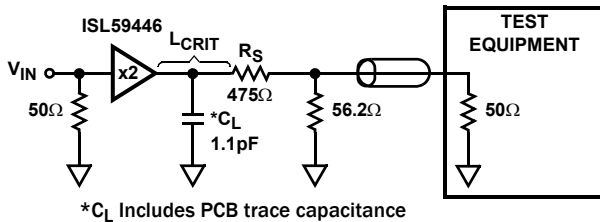

FIGURE 29C. 500Ω TEST CIRCUIT WITH 50Ω LOAD

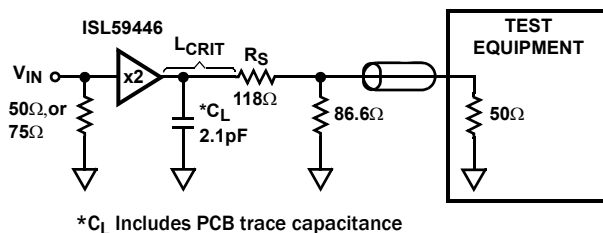

FIGURE 29D. 150Ω TEST CIRCUIT WITH 50Ω LOAD

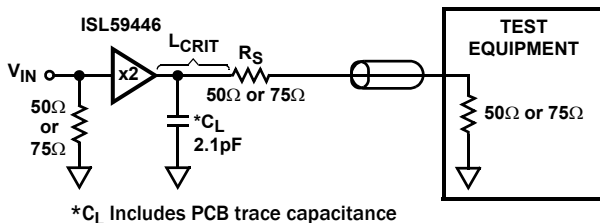

FIGURE 29E. BACKLOADED TEST CIRCUIT FOR 75Ω VIDEO CABLE APPLICATION

AC Test Circuits

Figures 29C and 29D illustrate the optimum output load for testing AC performance at 500Ω and 150Ω loads. Figure 29E illustrates the optimum output load for 50Ω and 75Ω cable-driving.

Application Information

General

Key features of the ISL59446 include a fixed gain of 2, buffered high impedance analog inputs and excellent AC performance at output loads down to 150Ω for video cable-driving. The current feedback output amplifiers are stable operating into capacitive loads.

For the best isolation and crosstalk rejection, all GND pins and NIC pins must connect to the GND plane.

AC Design Considerations

High speed current-feed amplifiers are sensitive to capacitance at the inverting input and output terminals. The ISL59446 has an internally set gain of 2, so the inverting input is not accessible. Capacitance at the output terminal increases gain peaking (Figure 2) and pulse overshoot (Figures 20 and 21). The AC response of the ISL59446 is optimized for a total output capacitance of up to 2.1pF over the load range of 150Ω to 500Ω. When PCB trace capacitance and component capacitance exceed 2pF, pulse overshoot becomes strongly dependent on the input pulse amplitude and slew rate. This effect is shown in Figures 20 and 21, which show approximate pulse overshoot as a function of input slew rate and output capacitance. Fast pulse rise and fall times (<150ns) at input amplitudes above 0.2V, cause the input pulse slew rate to exceed the 1600V/μs output slew rate of the ISL59446. At 125ps rise time, pulse input amplitudes >0.2V cause slew rate limit operation. Increasing levels of output capacitance reduce stability resulting in increased overshoot, and settling time.

PC board trace length should be kept to a minimum in order to minimize output capacitance and prevent the need for controlled impedance lines. At 500MHz trace lengths approaching 1" begin exhibiting transmission line behavior and may cause excessive ringing if controlled impedance traces are not used. Figure 29A shows the optimum interstage circuit when the total output trace length is less than the critical length of the highest signal frequency.

For applications where pulse response is critical and where interstage distances exceed L_{CRIT} , the circuit shown in Figure 29B is recommended. Resistor R_S constrains the capacitance seen by the amplifier output to the trace capacitance from the output pin to the resistor. Therefore, R_S should be placed as close to the ISL59446 output pin as possible. For interstage distances much greater than L_{CRIT} , the back-loaded circuit shown in Figure 29E should be used with controlled impedance PCB lines, with R_S and R_L equal to the controlled impedance.

For applications where interstage distances are long, but pulse response is not critical, capacitor C_S can be added to low values of R_S to form a low-pass filter to dampen pulse overshoot. This approach avoids the need for the large gain correction required by the -6dB attenuation of the back-loaded controlled impedance interconnect. Load resistor R_L is still required but can be 500Ω or greater, resulting in a much smaller attenuation factor.

Control Signals

S0, S1, $\overline{\text{ENABLE}}$, HIZ - These are binary coded, TTL/CMOS compatible control inputs. The S0, S1 pins select the inputs. All three amplifiers are switched simultaneously from their respective inputs. The $\overline{\text{ENABLE}}$ pin is used to disable the part to save power, and the HIZ pin to set the output stage in a high impedance state. For control signal rise and fall times less than 10ns the use of termination resistors close to the part may be necessary to prevent reflections and to minimize transients coupled to the output.

Power-Up Considerations

The ESD protection circuits use internal diodes from all pins to the V+ and V- supplies. In addition, a dV/dT-triggered clamp is connected between the V+ and V- pins, as shown in the Equivalent Circuits 1 through 4 section of the Pin Description table on [page 2](#). The dV/dT triggered clamp imposes a maximum supply turn-on slew rate of 1V/ μs . Damaging currents can flow for power supply rates-of-rise in excess of 1V/ μs , such as during hot plugging. Under these conditions, additional methods should be employed to ensure the rate of rise is not exceeded.

Consideration must be given to the order in which power is applied to the V+ and V- pins, as well as analog and logic input pins. Schottky diodes (Motorola MBR0550T or equivalent) connected from V+ to ground and V- to ground ([Figure 30](#)) will shunt damaging currents away from the internal V+ and V- ESD diodes in the event that the V+ supply is applied to the device before the V- supply.

If positive voltages are applied to the logic or analog video input pins before V+ is applied, current will flow through the internal ESD diodes to the V+ pin. The presence of large decoupling capacitors and the loading effect of other circuits connected to V+, can result in damaging currents through the ESD diodes and other active circuits within the device. Therefore, adequate current limiting on the digital and analog inputs is needed to prevent damage during the time the voltages on these inputs are more positive than V+.

HIZ State

An internal pull-down resistor ensures the device will be active with no connection to the HIZ pin. The HIZ state is established within approximately 20ns ([Figure 27](#)) by placing a logic high

(>2V) on the HIZ pin. If the HIZ state is selected, the output impedance is $\sim 1000\Omega$ ([Figure 9](#)). The supply current during this state is same as the active state.

$\overline{\text{ENABLE}}$ and Power-Down States

The enable pin is active low. An internal pull-down resistor ensures the device will be active with no connection to the $\overline{\text{ENABLE}}$ pin. The power-down state is established within approximately 200ns ([Figure 25](#)), if a logic high (>2V) is placed on the $\overline{\text{ENABLE}}$ pin. In the power-down state, the output has no leakage but has a large variable capacitance (on the order of 15pF), and is capable of being back-driven. Under this condition, large incoming slew rates can cause fault currents of tens of mA. Therefore, the parallel connection of multiple outputs is not recommended unless the application can tolerate the limited power-down output impedance.

Limiting the Output Current

No output short circuit current limit exists on these parts. All applications need to limit the output current to less than 50mA. Adequate thermal heat sinking of the parts is also required.

PC Board Layout

The AC performance of this circuit depends greatly on the care taken in designing the PC board. The following are recommendations to achieve optimum high frequency performance from your PC board.

- The use of low inductance components such as chip resistors and chip capacitors is strongly recommended.
- Minimize signal trace lengths. Trace inductance and capacitance can easily limit circuit performance. Avoid sharp corners, use rounded corners when possible. Vias in the signal lines add inductance at high frequency and should be avoided. PCB traces greater than 1" begin to exhibit transmission line characteristics with signal rise/fall times of 1ns or less. High frequency performance may be degraded for traces greater than one inch, unless strip line are used.
- Match channel-channel analog I/O trace lengths and layout symmetry. This will minimize propagation delay mismatches.

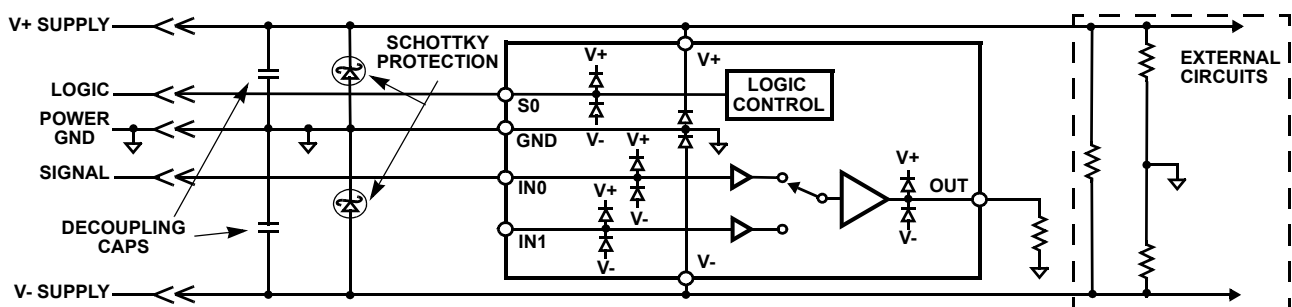

FIGURE 30. SCHOTTKY PROTECTION CIRCUIT

- Maximize use of AC decoupled PCB layers. All signal I/O lines should be routed over continuous ground planes (i.e., no split planes or PCB gaps under these lines). Avoid vias in the signal I/O lines.
- Use proper value and location of termination resistors. Termination resistors should be as close to the device as possible.
- When testing use good quality connectors and cables, matching cable types and keeping cable lengths to a minimum.
- Minimum of 2 power supply decoupling capacitors are recommended (1000pF, 0.01μF) as close to the devices as possible - avoid vias between the cap and the device because vias add unwanted inductance. Larger caps can be further away. When vias are required in a layout, they should be routed as far away from the device as possible.
- The NIC pins are placed on both sides of the input pins. These pins are not internally connected to the die. It is recommended these pins be tied to ground to minimize crosstalk.

The QFN Package Requires Additional PCB Layout Rules for the Thermal Pad

The thermal pad is electrically connected to V-supply through the high resistance IC substrate. Its primary function is to provide heat sinking for the IC. However, because of the connection to the V-supply through the substrate, the thermal pad must be tied to the V-supply to prevent unwanted current flow to the thermal pad. Do **not** tie this pin to GND as this could result in large back biased currents flowing between GND and V-. The ISL59446 package has pad dimensions of D2 = 2.48mm and E2 = 3.4mm.

Maximum AC performance is achieved if the thermal pad is attached to a dedicated decoupled layer in a multi-layered PC board. In cases where a dedicated layer is not possible, AC performance may be reduced at upper frequencies.

- The thermal pad requirements are proportional to power dissipation and ambient temperature. A dedicated layer eliminates the need for individual thermal pad area. When a dedicated layer is not possible a 1" x 1" pad area is sufficient for the ISL59446 that is dissipating 0.5W in +50 °C ambient temperature. Pad area requirements should be evaluated on a case-by-case basis.

Revision History

The revision history provided is for informational purposes only and is believed to be accurate, but not warranted. Please go to web to make sure you have the latest Rev.

| DATE | REVISION | CHANGE |
|---------------|----------|---|
| July 31, 2014 | FN6261.3 | Added Revision History. Electrical Spec Table on page 4 - made 3 limit changes as follows: +Is Enabled MAX from 48 to 50mA +Is Disabled MAX from 3.8 to 4mA -Is Enabled MIN from -45mA to -46mA |

About Intersil

Intersil Corporation is a leading provider of innovative power management and precision analog solutions. The company's products address some of the largest markets within the industrial and infrastructure, mobile computing and high-end consumer markets.

For the most updated datasheet, application notes, related documentation and related parts, please see the respective product information page found at www.intersil.com.

You may report errors or suggestions for improving this datasheet by visiting www.intersil.com/ask.

Reliability reports are also available from our website at www.intersil.com/support

© Copyright Intersil Americas LLC 2006-2014. All Rights Reserved.
All trademarks and registered trademarks are the property of their respective owners.

For additional products, see www.intersil.com/en/products.html

Intersil products are manufactured, assembled and tested utilizing ISO9001 quality systems as noted in the quality certifications found at www.intersil.com/en/support/qualandreliability.html

Intersil products are sold by description only. Intersil may modify the circuit design and/or specifications of products at any time without notice, provided that such modification does not, in Intersil's sole judgment, affect the form, fit or function of the product. Accordingly, the reader is cautioned to verify that datasheets are current before placing orders. Information furnished by Intersil is believed to be accurate and reliable. However, no responsibility is assumed by Intersil or its subsidiaries for its use; nor for any infringements of patents or other rights of third parties which may result from its use. No license is granted by implication or otherwise under any patent or patent rights of Intersil or its subsidiaries.

For information regarding Intersil Corporation and its products, see www.intersil.com

Quad Flat No-Lead Plastic Package (QFN)
Micro Lead Frame Plastic Package (MLFP)

L32.5x6A (One of 10 Packages in MDP0046)
32 LEAD QUAD FLAT NO-LEAD PLASTIC PACKAGE
(COMPLIANT TO JEDEC MO-220)

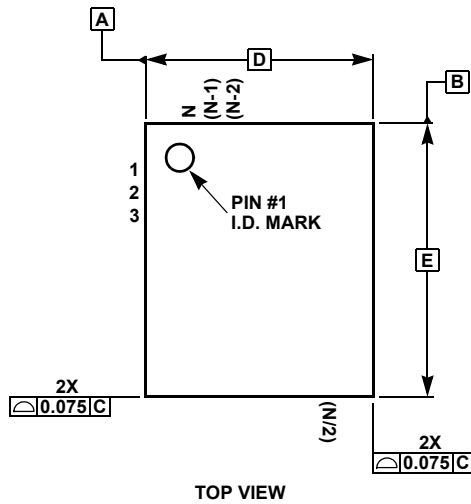

TOP VIEW

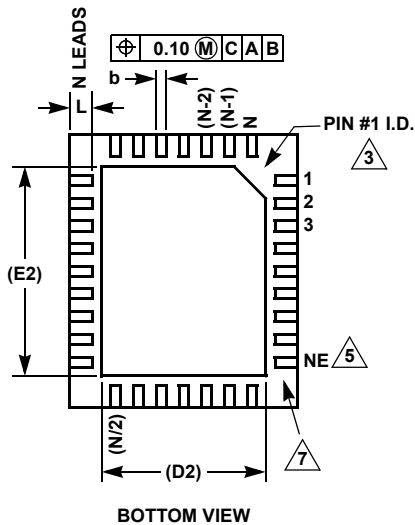

BOTTOM VIEW

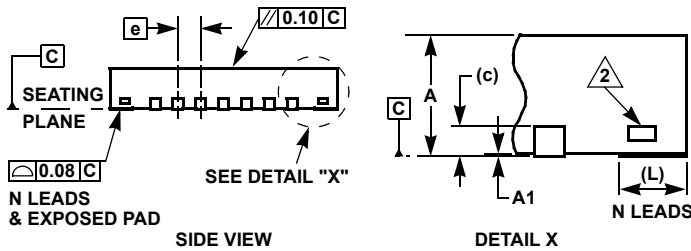

SIDE VIEW

DETAIL X

| SYMBOL | MILLIMETERS | | | NOTES |
|--------|-------------|---------|------|-------|
| | MIN | NOMINAL | MAX | |
| A | 0.80 | 0.90 | 1.00 | - |
| A1 | 0.00 | 0.02 | 0.05 | - |
| D | 5.00 BSC | | | - |
| D2 | 2.48 REF | | | - |
| E | 6.00 BSC | | | - |
| E2 | 3.40 REF | | | - |
| L | 0.45 | 0.50 | 0.55 | - |
| b | 0.17 | 0.22 | 0.27 | - |
| c | 0.20 REF | | | - |
| e | 0.50 BSC | | | - |
| N | 32 REF | | | 4 |
| ND | 7 REF | | | 6 |
| NE | 9 REF | | | 5 |

Rev 1 2/09

NOTES:

1. Dimensioning and tolerancing per ASME Y14.5M-1994.
2. Tiebar view shown is a non-functional feature.
3. Bottom-side pin #1 I.D. is a diepad chamfer as shown.
4. N is the total number of terminals on the device.
5. NE is the number of terminals on the "E" side of the package (or Y-direction).
6. ND is the number of terminals on the "D" side of the package (or X-direction). ND = (N/2)-NE.
7. Inward end of terminal may be square or circular in shape with radius (b/2) as shown.