

Photomicrosensor (Transmissive) EE-SX1031

■ Dimensions

Note: All units are in millimeters unless otherwise indicated.

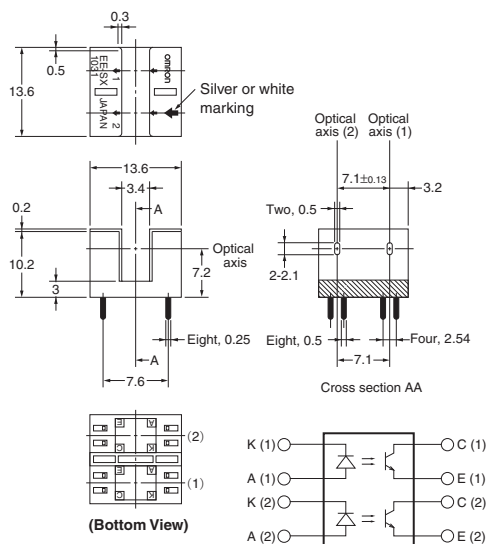

■ Features

- High resolution with a 0.5-mm-wide aperture.
- Separate LED/Phototransistor combinations within a single housing.
- PCB mounting type.
- RoHS Compliant.

■ Absolute Maximum Ratings (Ta = 25°C)

Item		Symbol	Rated value
Emitter	Forward current	I_F	50 mA (see note)
	Reverse voltage	V_R	4 V
Detector	Collector–Emitter voltage	V_{CEO}	30 V
	Collector current	I_C	20 mA
	Collector dissipation	P_C	100 mW
Ambient temperature	Operating	T_{opr}	–25°C to 85°C
	Storage	T_{stg}	–30°C to 100°C
Soldering temperature		T_{sol}	260°C

Note: 1. Refer to the temperature rating chart if the ambient temperature exceeds 25°C.

2. Complete soldering within 10 seconds.

■ Ordering Information

Description	Model
Photomicrosensor (transmissive)	EE-SX1031

■ Electrical and Optical Characteristics (Ta = 25°C)

Item		Symbol	Value	Condition
Emitter	Forward voltage	V_F	1.2 V typ., 1.5 V max.	$I_F = 30$ mA
	Reverse current	I_R	0.01 μ A typ., 10 μ A max.	$V_R = 4$ V
	Peak emission wavelength	λ_P	940 nm typ.	$I_F = 20$ mA
Detector	Light current	I_L	0.5 to 14 mA max.	$I_F = 20$ mA, $V_{CE} = 10$ V
	Dark current	I_D	2 nA typ., 200 nA max.	$V_{CE} = 10$ V, 0 lx
	Collector–Emitter saturated voltage	$V_{CE(sat)}$	0.15 V typ., 0.4 V max.	$I_F = 20$ mA, $I_L = 0.1$ mA
	Peak spectral sensitivity wavelength	λ_P	850 nm typ.	$V_{CE} = 10$ V
Rising time (see note)		t_r	4 μ s typ.	$V_{CC} = 5$ V, $R_L = 100 \Omega$, $I_L = 5$ mA
Falling time		t_f	4 μ s typ.	$V_{CC} = 5$ V, $R_L = 100 \Omega$, $I_L = 5$ mA

Note: Refer to *Response Time Measurement Circuit*.

■ Engineering Data

Forward Current vs. Collector Dissipation Temperature Rating

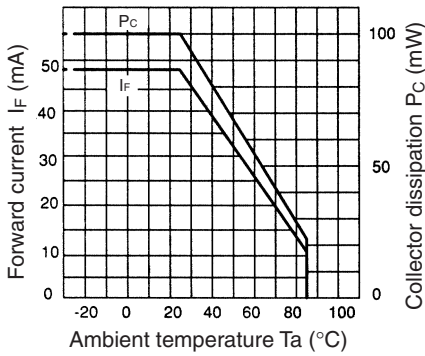

Forward Current vs. Forward Voltage Characteristics (Typical)

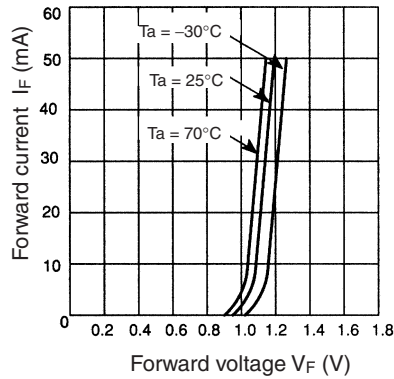

Light Current vs. Forward Current Characteristics (Typical)

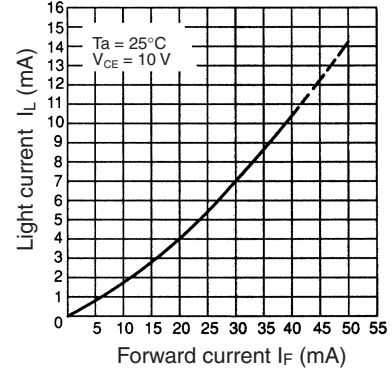

Light Current vs. Collector-Emitter Voltage Characteristics (Typical)

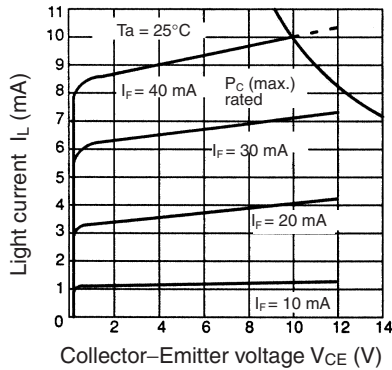

Dark Current vs. Ambient Temperature Characteristics (Typical)

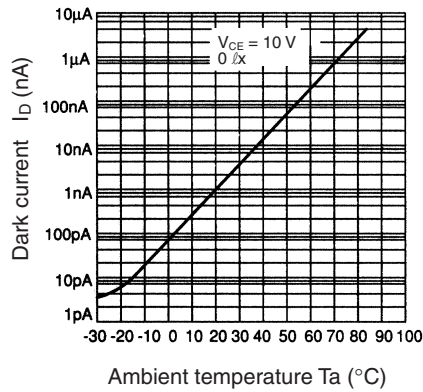

Light Current vs. Ambient Temperature Characteristics (Typical)

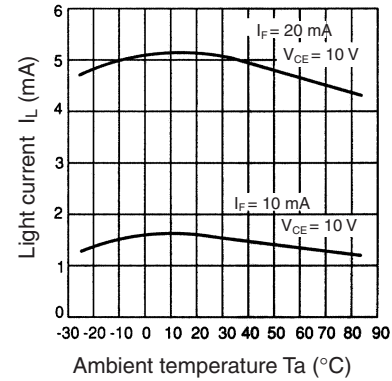

Sensing Position Characteristics (Typical)

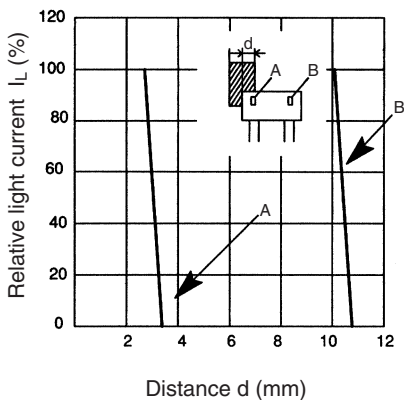

Response Time vs. Load Resistance Characteristics (Typical)

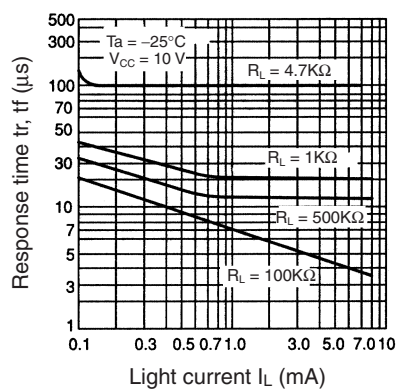

Response Time Measurement Circuit

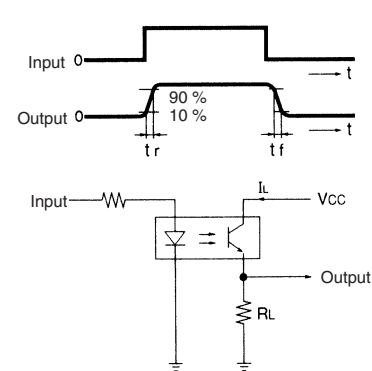

Note: The operating conditions of the Photomicrosensor must be within the absolute maximum rating ranges.

A large grid of 20 columns and 30 rows of small squares, intended for taking notes. The grid is composed of thin, light gray lines forming a uniform pattern across the page.

All sales are subject to Omron Electronic Components LLC standard terms and conditions of sale, which can be found at http://www.components.omron.com/components/web/webfiles.nsf/sales_terms.html

ALL DIMENSIONS SHOWN ARE IN MILLIMETERS.

To convert millimeters into inches, multiply by 0.03937. To convert grams into ounces, multiply by 0.03527.

OMRON[®]

**OMRON ELECTRONIC
COMPONENTS LLC**

55 E. Commerce Drive, Suite B
Schaumburg, IL 60173

847-882-2288

OMRON ON-LINE

Global - <http://www.omron.com>

USA - <http://www.components.omron.com>

Mouser Electronics

Authorized Distributor

Click to View Pricing, Inventory, Delivery & Lifecycle Information:

[Omron:](#)

[EE-SX1031](#)