

Please read this notice before using the TAIYO YUDEN products.

## REMINDERS

- Product information in this catalog is as of October 2018. All of the contents specified herein are subject to change without notice due to technical improvements, etc. Therefore, please check for the latest information carefully before practical application or use of our products.

Please note that TAIYO YUDEN shall not be in any way responsible for any damages and defects in products or equipment incorporating our products, which are caused under the conditions other than those specified in this catalog or individual product specification sheets.

- Please contact TAIYO YUDEN for further details of product specifications as the individual product specification sheets are available.
- Please conduct validation and verification of our products in actual condition of mounting and operating environment before using our products.
- The products listed in this catalog are intended for use in general electronic equipment (e.g., AV equipment, OA equipment, home electric appliances, office equipment, information and communication equipment including, without limitation, mobile phone, and PC) and medical equipment classified as Class I or II by IMDRF. Please be sure to contact TAIYO YUDEN for further information before using the products for any equipment which may directly cause loss of human life or bodily injury (e.g., transportation equipment including, without limitation, automotive powertrain control system, train control system, and ship control system, traffic signal equipment, disaster prevention equipment, medical equipment classified as Class III by IMDRF, highly public information network equipment including, without limitation, telephone exchange, and base station).

Please do not incorporate our products into any equipment requiring high levels of safety and/or reliability (e.g., aerospace equipment, aviation equipment\*, medical equipment classified as Class IV by IMDRF, nuclear control equipment, undersea equipment, military equipment).

\*Note: There is a possibility that our products can be used only for aviation equipment that does not directly affect the safe operation of aircraft (e.g., in-flight entertainment, cabin light, electric seat, cooking equipment) if such use meets requirements specified separately by TAIYO YUDEN. Please be sure to contact TAIYO YUDEN for further information before using our products for such aviation equipment.

When our products are used even for high safety and/or reliability-required devices or circuits of general electronic equipment, it is strongly recommended to perform a thorough safety evaluation prior to use of our products and to install a protection circuit as necessary.

Please note that unless you obtain prior written consent of TAIYO YUDEN, TAIYO YUDEN shall not be in any way responsible for any damages incurred by you or third parties arising from use of the products listed in this catalog for any equipment requiring inquiry to TAIYO YUDEN or prohibited for use by TAIYO YUDEN as described above.

- Information contained in this catalog is intended to convey examples of typical performances and/or applications of our products and is not intended to make any warranty with respect to the intellectual property rights or any other related rights of TAIYO YUDEN or any third parties nor grant any license under such rights.
- Please note that the scope of warranty for our products is limited to the delivered our products themselves and TAIYO YUDEN shall not be in any way responsible for any damages resulting from a fault or defect in our products. Notwithstanding the foregoing, if there is a written agreement (e.g., supply and purchase agreement, quality assurance agreement) signed by TAIYO YUDEN and your company, TAIYO YUDEN will warrant our products in accordance with such agreement.
- The contents of this catalog are applicable to our products which are purchased from our sales offices or authorized distributors (hereinafter "TAIYO YUDEN's official sales channel"). Please note that the contents of this catalog are not applicable to our products purchased from any seller other than TAIYO YUDEN's official sales channel.
- Caution for Export  
Some of our products listed in this catalog may require specific procedures for export according to "U.S. Export Administration Regulations", "Foreign Exchange and Foreign Trade Control Law" of Japan, and other applicable regulations. Should you have any questions on this matter, please contact our sales staff.

# MULTILAYER CERAMIC CAPACITORS



WAVE REFLOW

## PARTS NUMBER

|   |   |   |   |   |   |   |   |   |   |   |   |   |   |   |   |   |
|---|---|---|---|---|---|---|---|---|---|---|---|---|---|---|---|---|
| J | M | K | 3 | 1 | 6 | △ | B | J | 1 | 0 | 6 | M | L | - | T | △ |
| ① | ② | ③ | ④ | ⑤ | ⑥ | ⑦ | ⑧ | ⑨ | ⑩ | ⑪ | ⑫ |   |   |   |   |   |

△ = Blank space

### ① Rated voltage

| Code | Rated voltage [VDC] |
|------|---------------------|
| P    | 2.5                 |
| A    | 4                   |
| J    | 6.3                 |
| L    | 10                  |
| E    | 16                  |
| T    | 25                  |
| G    | 35                  |
| U    | 50                  |
| H    | 100                 |
| Q    | 250                 |
| S    | 630                 |
| X    | 2000                |

### ② Series name

| Code | Series name                                     |
|------|---|
| M    | Multilayer ceramic capacitor                    |
| V    | Multilayer ceramic capacitor for high frequency |
| W    | LW reverse type multilayer capacitor            |

### ③ End termination

| Code | End termination                             |
|------|---|
| K    | Plated                                      |
| S    | Cu Internal Electrodes (For High Frequency) |

### ④ Dimension (L × W)

| Type | Dimensions (L × W) [mm] | EIA (inch) |
|------|-------------------------|------------|
| 021  | 0.25 × 0.125            | 008004     |
| 042  | 0.4 × 0.2               | 01005      |
| 063  | 0.6 × 0.3               | 0201       |
| 105  | 1.0 × 0.5               | 0402       |
|      | 0.52 × 1.0 ※            | 0204       |
| 107  | 1.6 × 0.8               | 0603       |
|      | 0.8 × 1.6 ※             | 0306       |
| 212  | 2.0 × 1.25              | 0805       |
|      | 1.25 × 2.0 ※            | 0508       |
| 316  | 3.2 × 1.6               | 1206       |
| 325  | 3.2 × 2.5               | 1210       |
| 432  | 4.5 × 3.2               | 1812       |

Note : ※LW reverse type (□WK) only

### ⑤ Dimension tolerance

| Code | Type | L [mm]              | W [mm]               | T [mm]   |
|------|------|---------------------|----------------------|--|
| △    | ALL  | Standard            | Standard             | Standard   |
| A    | 063  | 0.6 ± 0.05          | 0.3 ± 0.05           | 0.3 ± 0.05   |
|      | 105  | 1.0 ± 0.10          | 0.5 ± 0.10           | 0.5 ± 0.10   |
|      | 107  | 1.6 + 0.15 / - 0.05 | 0.8 + 0.15 / - 0.05  | 0.8 + 0.15 / - 0.05                                |
|      | 212  | 2.0 + 0.15 / - 0.05 | 1.25 + 0.15 / - 0.05 | 0.45 ± 0.05<br>0.85 ± 0.10<br>1.25 + 0.15 / - 0.05 |
|      | 316  | 3.2 ± 0.20          | 1.6 ± 0.20           | 0.85 ± 0.10<br>1.6 ± 0.20                          |
|      | 325  | 3.2 ± 0.30          | 2.5 ± 0.30           | 2.5 ± 0.30   |
| B    | 063  | 0.6 ± 0.09          | 0.3 ± 0.09           | 0.3 ± 0.09   |
|      | 105  | 1.0 + 0.15 / - 0.05 | 0.5 + 0.15 / - 0.05  | 0.5 + 0.15 / - 0.05                                |
|      | 107  | 1.6 + 0.20 / - 0    | 0.8 + 0.20 / - 0     | 0.45 ± 0.05<br>0.8 + 0.20 / - 0                    |
|      | 212  | 2.0 + 0.20 / - 0    | 1.25 + 0.20 / - 0    | 0.45 ± 0.05<br>0.85 ± 0.10<br>1.25 + 0.20 / - 0    |
|      | 316  | 3.2 ± 0.30          | 1.6 ± 0.30           | 1.6 ± 0.30   |
| C    | 105  | 1.0 + 0.20 / - 0    | 0.5 + 0.20 / - 0     | 0.5 + 0.20 / - 0                                   |
| E    | 105  | 1.0 + 0.30 / - 0    | 0.5 + 0.30 / - 0     | 0.5 + 0.30 / - 0                                   |

Note: cf. STANDARD EXTERNAL DIMENSIONS

△ = Blank space

### ⑥ Temperature characteristics code

■ High dielectric type (Excluding Super low distortion multilayer ceramic capacitor)

| Code  | Applicable standard | Temperature range [°C] | Ref. Temp. [°C] | Capacitance change | Capacitance tolerance | Tolerance code |
|-------|---------------------|------------------------|-----------------|--------------------|-----------------------|----------------|
| BJ    | JIS B               | -25 ~ + 85             | 20              | ± 10%              | ± 10%                 | K              |
|       | EIA X5R             | -55 ~ + 85             | 25              | ± 15%              | ± 20%                 | M              |
| B7    | EIA X7R             | -55 ~ + 125            | 25              | ± 15%              | ± 10%                 | K              |
|       |                     |                        |                 |                    | ± 20%                 | M              |
| C6    | EIA X6S             | -55 ~ + 105            | 25              | ± 22%              | ± 10%                 | K              |
|       |                     |                        |                 |                    | ± 20%                 | M              |
| C7    | EIA X7S             | -55 ~ + 125            | 25              | ± 22%              | ± 10%                 | K              |
|       |                     |                        |                 |                    | ± 20%                 | M              |
| LD(※) | EIA X5R             | -55 ~ + 85             | 25              | ± 15%              | ± 10%                 | K              |
|       |                     |                        |                 |                    | ± 20%                 | M              |

Note : ※LD Low distortion high value multilayer ceramic capacitor

△ = Blank space

► This catalog contains the typical specification only due to the limitation of space. When you consider the purchase of our products, please check our product specification sheets. For details of each product (characteristics graph, reliability information, precautions for use, and so on), see our website (<http://www.ty-top.com/>).

■ Temperature compensating type

| Code | Applicable standard |     | Temperature range [°C] | Ref. Temp. [°C] | Capacitance change | Capacitance tolerance | Tolerance code |
|------|---------------------|-----|------------------------|-----------------|--------------------|-----------------------|----------------|
| CG   | EIA                 | C0G | -55 ~ +125             | 25              | 0 ± 30ppm/°C       | ± 0.05pF              | A              |
|      |                     |     |                        |                 |                    | ± 0.1pF               | B              |
|      |                     |     |                        |                 |                    | ± 0.25pF              | C              |
|      |                     |     |                        |                 |                    | ± 0.5pF               | D              |
|      |                     |     |                        |                 |                    | ± 5%                  | J              |
| UJ   | JIS                 | UJ  | -55 ~ +125             | 20              | -750 ± 120ppm/°C   | ± 0.25pF              | C              |
|      |                     |     |                        |                 |                    | ± 0.5pF               | D              |
|      | EIA                 | U2J |                        | 25              |                    | ± 5%                  | J              |
| UK   | JIS                 | UK  | -55 ~ +125             | 20              | -750 ± 250ppm/°C   | ± 0.25pF              | C              |
|      | EIA                 | U2K | -55 ~ +125             | 25              |                    |                       |                |
| SL   | JIS                 | SL  | -55 ~ +125             | 20              | +350 ~ -1000ppm/°C | ± 5%                  | J              |

⑥ Series code

• Super low distortion multilayer ceramic capacitor

| Code | Series code |
|------|-------------|
| SD   | Standard    |

• Medium-High Voltage Multilayer Ceramic Capacitor

| Code | Series code |
|------|-------------|
| SD   | Standard    |

⑦ Nominal capacitance

| Code (example) | Nominal capacitance |
|----------------|---------------------|
| 0R5            | 0.5pF               |
| 010            | 1pF                 |
| 100            | 10pF                |
| 101            | 100pF               |
| 102            | 1,000pF             |
| 103            | 10,000pF            |
| 104            | 0.1 μF              |
| 105            | 1.0 μF              |
| 106            | 10 μF               |
| 107            | 100 μF              |

Note : R=Decimal point

⑧ Capacitance tolerance

| Code | Capacitance tolerance |
|------|-----------------------|
| A    | ± 0.05pF              |
| B    | ± 0.1pF               |
| C    | ± 0.25pF              |
| D    | ± 0.5pF               |
| F    | ± 1pF                 |
| G    | ± 2%                  |
| J    | ± 5%                  |
| K    | ± 10%                 |
| M    | ± 20%                 |
| Z    | +80 / -20%            |

⑨ Thickness

| Code | Thickness [mm]         |
|------|------------------------|
| K    | 0.125                  |
| H    | 0.13                   |
| E    | 0.18                   |
| C    | 0.2                    |
| D    |                        |
| P    |                        |
| T    | 0.3                    |
| K    | 0.45 (107type or more) |
| V    | 0.5                    |
| W    |                        |
| A    | 0.8                    |
| D    | 0.85 (212type or more) |
| F    | 1.15                   |
| G    | 1.25                   |
| L    | 1.6                    |
| N    | 1.9                    |
| Y    | 2.0 max                |
| M    | 2.5                    |

⑩ Special code

| Code | Special code |
|------|--------------|
| -    | Standard     |

⑪ Packaging

| Code | Packaging   |
|------|---|
| F    | φ178mm Taping (2mm pitch)   |
| T    | φ178mm Taping (4mm pitch)   |
| P    | φ178mm Taping (4mm pitch, 1000 pcs/reel)<br>325 type (Thickness code M) |
| R    | φ178mm Taping (2mm pitch) 105type only<br>(Thickness code E,H)          |
| W    | φ178mm Taping (1mm pitch) 021/042type only                              |

⑫ Internal code

| Code | Internal code |
|------|---------------|
| Δ    | Standard      |

► This catalog contains the typical specification only due to the limitation of space. When you consider the purchase of our products, please check our product specification sheets. For details of each product (characteristics graph, reliability information, precautions for use, and so on), see our website (<http://www.ty-top.com/>).

STANDARD EXTERNAL DIMENSIONS

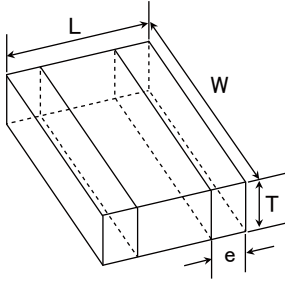
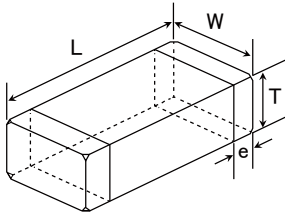

※ LW reverse type

| Type( EIA )     | Dimension [mm] |             |              |    |                |
|-----------------|----------------|-------------|--------------|----|----------------|
|                 | L              | W           | T            | *1 | e              |
| □MK021 (008004) | 0.25±0.013     | 0.125±0.013 | 0.125±0.013  | K  | 0.0675±0.0275  |
| □VS021 (008004) | 0.25±0.013     | 0.125±0.013 | 0.125±0.013  | K  | 0.0675±0.0275  |
| □MK042 (01005)  | 0.4±0.02       | 0.2±0.02    | 0.2±0.02     | C  | 0.1±0.03       |
| □VS042 (01005)  |                |             | 0.2±0.02     | D  |                |
| □MK063 (0201)   | 0.6±0.03       | 0.3±0.03    | 0.3±0.03     | P  | 0.15±0.05      |
|                 |                |             | 0.3±0.03     | T  |                |
| □MK105 (0402)   | 1.0±0.05       | 0.5±0.05    | 0.13±0.02    | H  | 0.25±0.10      |
|                 |                |             | 0.18±0.02    | E  |                |
|                 |                |             | 0.2±0.02     | C  |                |
|                 |                |             | 0.3±0.03     | P  |                |
|                 |                |             | 0.5±0.05     | V  |                |
| □VK105 (0402)   | 1.0±0.05       | 0.5±0.05    | 0.5±0.05     | W  | 0.25±0.10      |
| □WK105 (0204) ※ | 0.52±0.05      | 1.0±0.05    | 0.3±0.05     | P  | 0.18±0.08      |
| □MK107 (0603)   | 1.6±0.10       | 0.8±0.10    | 0.45±0.05    | K  | 0.35±0.25      |
|                 |                |             | 0.8±0.10     | A  |                |
| □WK107 (0306) ※ | 0.8±0.10       | 1.6±0.10    | 0.5±0.05     | V  | 0.25±0.15      |
| □MK212 (0805)   | 2.0±0.10       | 1.25±0.10   | 0.45±0.05    | K  | 0.5±0.25       |
|                 |                |             | 0.85±0.10    | D  |                |
|                 |                |             | 1.25±0.10    | G  |                |
| □WK212 (0508) ※ | 1.25±0.15      | 2.0±0.15    | 0.85±0.10    | D  | 0.3±0.2        |
| □MK316 (1206)   | 3.2±0.15       | 1.6±0.15    | 0.85±0.10    | D  | 0.5+0.35/-0.25 |
|                 |                |             | 1.15±0.10    | F  |                |
|                 |                |             | 1.6±0.20     | L  |                |
| □MK325 (1210)   | 3.2±0.30       | 2.5±0.20    | 0.85±0.10    | D  | 0.6±0.3        |
|                 |                |             | 1.15±0.10    | F  |                |
|                 |                |             | 1.9±0.20     | N  |                |
|                 |                |             | 1.9+0.1/-0.2 | Y  |                |
|                 |                |             | 2.5±0.20     | M  |                |
| □MK432 (1812)   | 4.5±0.40       | 3.2±0.30    | 2.0+0/-0.30  | Y  | 0.6±0.4        |
|                 |                |             | 2.5±0.20     | M  | 0.9±0.6        |

Note : ※. LW reverse type, \*1.Thickness code

STANDARD QUANTITY

| Type   | EIA (inch) | Dimension |         | Standard quantity [pcs] |               |     |      |
|--------|------------|-----------|---------|-------------------------|---------------|-----|------|
|        |            | [mm]      | Code    | Paper tape              | Embossed tape |     |      |
| 021    | 008004     | 0.125     | K       | —                       | 50000         |     |      |
| 042    | 01005      | 0.2       | C       | —                       | 40000         |     |      |
|        |            |           | D       |                         |               |     |      |
| 063    | 0201       | 0.3       | P       | 15000                   | —             |     |      |
|        |            |           | T       |                         |               |     |      |
| 105    | 0402       | 0.13      | H       | —                       | 20000         |     |      |
|        |            |           | E       | —                       | 15000         |     |      |
|        |            |           | C       | 20000                   | —             |     |      |
|        |            |           | P       | 15000                   | —             |     |      |
|        |            |           | V       | 10000                   | —             |     |      |
|        | W          |           |         |                         |               |     |      |
| 0204 ※ | 0.30       | P         | —       | —                       |               |     |      |
| 107    | 0603       | 0.45      | K       | 4000                    | —             |     |      |
|        |            |           | A       |                         |               |     |      |
|        | 0306 ※     | 0.50      | V       | —                       | 4000          |     |      |
| 212    | 0805       | 0.45      | K       | 4000                    | —             |     |      |
|        |            |           | D       |                         |               |     |      |
|        |            |           | G       |                         |               | —   | 3000 |
| 0508 ※ | 0.85       | D         | 4000    | —                       |               |     |      |
| 316    | 1206       | 0.85      | D       | 4000                    | —             |     |      |
|        |            |           | F       |                         |               | —   | 3000 |
|        |            |           | L       |                         |               | —   | 2000 |
| 325    | 1210       | 0.85      | D       | —                       | 2000          |     |      |
|        |            |           | F       |                         |               |     |      |
|        |            |           | N       |                         |               |     |      |
|        |            |           | 2.0 max |                         |               | Y   |      |
|        |            |           | 2.5     |                         |               | M   | —    |
| 432    | 1812       | 2.0 max   | Y       | —                       | 1000          |     |      |
|        |            |           | 2.5     | M                       | —             | 500 |      |

Note : ※LW Reverse type (□WK)

▶ This catalog contains the typical specification only due to the limitation of space. When you consider the purchase of our products, please check our product specification sheets. For details of each product (characteristics graph, reliability information, precautions for use, and so on), see our website (<http://www.ty-top.com/>).

- All the Multilayer Ceramic Capacitors of the catalog lineup are RoHS Compliant.
- Capacitance tolerance code is applied to □ of part number.

Note)

- \*1 We may provide X7R/X7S for some items according to the individual specification.
- \*2 The exchange of individual specification is necessary depending on the application and circuit condition. Please contact TAIYO YUDEN sales channels.
- \*3 The size standard should look at ④Dimension, ⑤Dimension tolerance, and ⑨Thickness, and STANDARD EXTERNAL DIMENSIONS.

Multilayer Ceramic Capacitors (High dielectric type)

●021TYPE

【Temperature Characteristic BJ : X5R(-55~+85°C)】 0.125mm thickness(K)

| Part number 1    | Part number 2 | Rated voltage [V] | Temperature characteristics | Capacitance [F] | Capacitance tolerance [%] | tan δ [%] | HTLT              | Thickness*3 [mm] | Soldering R:Reflow W:Wave |
|------------------|---------------|-------------------|-----------------------------|-----------------|---------------------------|-----------|-------------------|------------------|---------------------------|
|                  |               |                   |                             |                 |                           |           | Rated voltage x % |                  |                           |
| EMK021 BJ221□K-W |               | 16                | X5R                         | 220 p           | ±10, ±20                  | 10        | 150               | 0.125±0.013      | R                         |
| EMK021 BJ471□K-W |               |                   | X5R                         | 470 p           | ±10, ±20                  | 10        | 150               | 0.125±0.013      | R                         |
| EMK021 BJ102□K-W |               |                   | X5R                         | 1000 p          | ±10, ±20                  | 10        | 150               | 0.125±0.013      | R                         |
| JMK021 BJ222□K-W |               | 6.3               | X5R                         | 2200 p          | ±10, ±20                  | 10        | 150               | 0.125±0.013      | R                         |
| JMK021 BJ472□K-W |               |                   | X5R                         | 4700 p          | ±10, ±20                  | 10        | 150               | 0.125±0.013      | R                         |
| JMK021 BJ103□K-W |               |                   | X5R                         | 0.01 μ          | ±10, ±20                  | 10        | 150               | 0.125±0.013      | R                         |
| AMK021 BJ223MK-W |               | 4                 | X5R                         | 0.022 μ         | ±20                       | 10        | 150               | 0.125±0.013      | R                         |

●042TYPE

【Temperature Characteristic BJ : B(-25~+85°C)/X5R(-55~+85°C)】 0.2mm thickness(C)

| Part number 1    | Part number 2 | Rated voltage [V] | Temperature characteristics | Capacitance [F] | Capacitance tolerance [%] | tan δ [%] | HTLT              | Thickness*3 [mm] | Soldering R:Reflow W:Wave |   |
|------------------|---------------|-------------------|-----------------------------|-----------------|---------------------------|-----------|-------------------|------------------|---------------------------|---|
|                  |               |                   |                             |                 |                           |           | Rated voltage x % |                  |                           |   |
| EMK042 BJ101□C-W |               | 16                | X5R                         | 100 p           | ±10, ±20                  | 5         | 200               | 0.2±0.02         | R                         |   |
| EMK042 BJ151□C-W |               |                   | X5R                         | 150 p           | ±10, ±20                  | 5         | 200               | 0.2±0.02         | R                         |   |
| EMK042 BJ221□C-W |               |                   | X5R                         | 220 p           | ±10, ±20                  | 5         | 200               | 0.2±0.02         | R                         |   |
| EMK042 BJ331□C-W |               |                   | X5R                         | 330 p           | ±10, ±20                  | 5         | 200               | 0.2±0.02         | R                         |   |
| EMK042 BJ471□C-W |               |                   | X5R                         | 470 p           | ±10, ±20                  | 5         | 200               | 0.2±0.02         | R                         |   |
| EMK042 BJ681□C-W |               |                   | X5R                         | 680 p           | ±10, ±20                  | 5         | 200               | 0.2±0.02         | R                         |   |
| EMK042 BJ102□C-W |               |                   | B                           | X5R             | 1000 p                    | ±10, ±20  | 5                 | 200              | 0.2±0.02                  | R |
| EMK042 BJ152□C-W |               |                   | X5R                         | 1500 p          | ±10, ±20                  | 10        | 150               | 0.2±0.02         | R                         |   |
| EMK042 BJ222□C-W |               |                   | X5R                         | 2200 p          | ±10, ±20                  | 10        | 150               | 0.2±0.02         | R                         |   |
| EMK042 BJ332□C-W |               |                   | X5R                         | 3300 p          | ±10, ±20                  | 10        | 150               | 0.2±0.02         | R                         |   |
| EMK042 BJ472□C-W |               |                   | X5R                         | 4700 p          | ±10, ±20                  | 10        | 150               | 0.2±0.02         | R                         |   |
| EMK042 BJ682□C-W |               |                   | X5R                         | 6800 p          | ±10, ±20                  | 10        | 150               | 0.2±0.02         | R                         |   |
| EMK042 BJ103□C-W |               |                   | X5R                         | 0.01 μ          | ±10, ±20                  | 10        | 150               | 0.2±0.02         | R                         |   |
| LMK042 BJ101□C-W |               |                   | X5R*1                       | 100 p           | ±10, ±20                  | 5         | 200               | 0.2±0.02         | R                         |   |
| LMK042 BJ151□C-W |               |                   | X5R*1                       | 150 p           | ±10, ±20                  | 5         | 200               | 0.2±0.02         | R                         |   |
| LMK042 BJ221□C-W |               |                   | X5R*1                       | 220 p           | ±10, ±20                  | 5         | 200               | 0.2±0.02         | R                         |   |
| LMK042 BJ331□C-W |               | X5R*1             | 330 p                       | ±10, ±20        | 5                         | 200       | 0.2±0.02          | R                |                           |   |
| LMK042 BJ471□C-W |               | X5R*1             | 470 p                       | ±10, ±20        | 5                         | 200       | 0.2±0.02          | R                |                           |   |
| LMK042 BJ681□C-W |               | X5R*1             | 680 p                       | ±10, ±20        | 5                         | 200       | 0.2±0.02          | R                |                           |   |
| LMK042 BJ102□C-W |               | B                 | X5R*1                       | 1000 p          | ±10, ±20                  | 5         | 200               | 0.2±0.02         | R                         |   |
| LMK042 BJ152□C-W |               | X5R               | 1500 p                      | ±10, ±20        | 10                        | 150       | 0.2±0.02          | R                |                           |   |
| LMK042 BJ222□C-W |               | X5R               | 2200 p                      | ±10, ±20        | 10                        | 150       | 0.2±0.02          | R                |                           |   |
| LMK042 BJ332□C-W |               | X5R               | 3300 p                      | ±10, ±20        | 10                        | 150       | 0.2±0.02          | R                |                           |   |
| LMK042 BJ472□C-W |               | X5R               | 4700 p                      | ±10, ±20        | 10                        | 150       | 0.2±0.02          | R                |                           |   |
| LMK042 BJ682□C-W |               | X5R               | 6800 p                      | ±10, ±20        | 10                        | 150       | 0.2±0.02          | R                |                           |   |
| LMK042 BJ103□C-W |               | X5R               | 0.01 μ                      | ±10, ±20        | 10                        | 150       | 0.2±0.02          | R                |                           |   |
| JMK042 BJ152□C-W |               | 6.3               | X5R*1                       | 1500 p          | ±10, ±20                  | 10        | 150               | 0.2±0.02         | R                         |   |
| JMK042 BJ222□C-W |               |                   | X5R*1                       | 2200 p          | ±10, ±20                  | 10        | 150               | 0.2±0.02         | R                         |   |
| JMK042 BJ332□C-W |               |                   | X5R*1                       | 3300 p          | ±10, ±20                  | 10        | 150               | 0.2±0.02         | R                         |   |
| JMK042 BJ472□C-W |               |                   | X5R*1                       | 4700 p          | ±10, ±20                  | 10        | 150               | 0.2±0.02         | R                         |   |
| JMK042 BJ682□C-W |               |                   | X5R*1                       | 6800 p          | ±10, ±20                  | 10        | 150               | 0.2±0.02         | R                         |   |
| JMK042 BJ103□C-W |               |                   | X5R*1                       | 0.01 μ          | ±10, ±20                  | 10        | 150               | 0.2±0.02         | R                         |   |
| JMK042 BJ223□C-W |               |                   | X5R                         | 0.022 μ         | ±10, ±20                  | 10        | 150               | 0.2±0.02         | R                         |   |
| JMK042 BJ473□C-W |               |                   | X5R                         | 0.047 μ         | ±10, ±20                  | 10        | 150               | 0.2±0.02         | R                         |   |
| JMK042 BJ104□C-W |               |                   | X5R                         | 0.1 μ           | ±10, ±20                  | 10        | 150               | 0.2±0.02         | R                         |   |
| AMK042 BJ473□C-W |               |                   | 4                           | X5R             | 0.047 μ                   | ±10, ±20  | 10                | 150              | 0.2±0.02                  | R |
| AMK042 BJ104□C-W |               |                   |                             | X5R             | 0.1 μ                     | ±10, ±20  | 10                | 150              | 0.2±0.02                  | R |

【Temperature Characteristic B7 : X7R(-55~+125°C)】 0.2mm thickness(C)

| Part number 1    | Part number 2 | Rated voltage [V] | Temperature characteristics | Capacitance [F] | Capacitance tolerance [%] | tan δ [%] | HTLT              | Thickness*3 [mm] | Soldering R:Reflow W:Wave |
|------------------|---------------|-------------------|-----------------------------|-----------------|---------------------------|-----------|-------------------|------------------|---------------------------|
|                  |               |                   |                             |                 |                           |           | Rated voltage x % |                  |                           |
| EMK042 B7101□C-W |               | 16                | X7R                         | 100 p           | ±10, ±20                  | 5         | 200               | 0.2±0.02         | R                         |
| EMK042 B7151□C-W |               |                   | X7R                         | 150 p           | ±10, ±20                  | 5         | 200               | 0.2±0.02         | R                         |
| EMK042 B7221□C-W |               |                   | X7R                         | 220 p           | ±10, ±20                  | 5         | 200               | 0.2±0.02         | R                         |
| EMK042 B7331□C-W |               |                   | X7R                         | 330 p           | ±10, ±20                  | 5         | 200               | 0.2±0.02         | R                         |
| EMK042 B7471□C-W |               |                   | X7R                         | 470 p           | ±10, ±20                  | 5         | 200               | 0.2±0.02         | R                         |
| EMK042 B7681□C-W |               |                   | X7R                         | 680 p           | ±10, ±20                  | 5         | 200               | 0.2±0.02         | R                         |
| EMK042 B7102□C-W |               |                   | X7R                         | 1000 p          | ±10, ±20                  | 5         | 200               | 0.2±0.02         | R                         |
| LMK042 B7101□C-W |               |                   | X7R                         | 100 p           | ±10, ±20                  | 5         | 200               | 0.2±0.02         | R                         |
| LMK042 B7151□C-W |               |                   | X7R                         | 150 p           | ±10, ±20                  | 5         | 200               | 0.2±0.02         | R                         |
| LMK042 B7221□C-W |               |                   | X7R                         | 220 p           | ±10, ±20                  | 5         | 200               | 0.2±0.02         | R                         |
| LMK042 B7331□C-W |               |                   | X7R                         | 330 p           | ±10, ±20                  | 5         | 200               | 0.2±0.02         | R                         |
| LMK042 B7471□C-W |               |                   | X7R                         | 470 p           | ±10, ±20                  | 5         | 200               | 0.2±0.02         | R                         |
| LMK042 B7681□C-W |               | X7R               | 680 p                       | ±10, ±20        | 5                         | 200       | 0.2±0.02          | R                |                           |
| LMK042 B7102□C-W |               | X7R               | 1000 p                      | ±10, ±20        | 5                         | 200       | 0.2±0.02          | R                |                           |

▶ This catalog contains the typical specification only due to the limitation of space. When you consider the purchase of our products, please check our product specification sheets. For details of each product (characteristics graph, reliability information, precautions for use, and so on), see our website (<http://www.ty-top.com/>).

## 063TYPE

[Temperature Characteristic BJ : B (-25~+85°C)/X5R(-55~+85°C)] 0.3mm thickness (P)

| Part number 1    | Part number 2 | Rated voltage [V] | Temperature characteristics |                  | Capacitance [F]  | Capacitance tolerance [%] | tan δ [%] | HTLT              | Thickness <sup>3</sup> [mm] | Soldering R:Reflow W:Wave |   |
|------------------|---------------|-------------------|-----------------------------|------------------|------------------|---------------------------|-----------|-------------------|-----------------------------|---------------------------|---|
|                  |               |                   |                             |                  |                  |                           |           | Rated voltage x % |                             |                           |   |
| UMK063 BJ101□P-F |               | 50                | B                           | X5R <sup>1</sup> | 100 p            | ±10, ±20                  | 3.5       | 200               | 0.3±0.03                    | R                         |   |
| UMK063 BJ151□P-F |               |                   | B                           | X5R <sup>1</sup> | 150 p            | ±10, ±20                  | 3.5       | 200               | 0.3±0.03                    | R                         |   |
| UMK063 BJ221□P-F |               |                   |                             | X5R <sup>1</sup> | 220 p            | ±10, ±20                  | 3.5       | 200               | 0.3±0.03                    | R                         |   |
| UMK063 BJ331□P-F |               |                   |                             | X5R <sup>1</sup> | 330 p            | ±10, ±20                  | 3.5       | 200               | 0.3±0.03                    | R                         |   |
| UMK063 BJ471□P-F |               |                   |                             | X5R <sup>1</sup> | 470 p            | ±10, ±20                  | 3.5       | 200               | 0.3±0.03                    | R                         |   |
| UMK063 BJ681□P-F |               |                   |                             | B                | X5R <sup>1</sup> | 680 p                     | ±10, ±20  | 3.5               | 200                         | 0.3±0.03                  | R |
| UMK063 BJ102□P-F |               |                   |                             | B                | X5R <sup>1</sup> | 1000 p                    | ±10, ±20  | 3.5               | 200                         | 0.3±0.03                  | R |
| UMK063 BJ152□P-F |               |                   |                             | B                | X5R              | 1500 p                    | ±10, ±20  | 5                 | 200                         | 0.3±0.03                  | R |
| UMK063 BJ222□P-F |               |                   |                             | B                | X5R              | 2200 p                    | ±10, ±20  | 5                 | 200                         | 0.3±0.03                  | R |
| UMK063 BJ332□P-F |               |                   |                             | B                | X5R              | 3300 p                    | ±10, ±20  | 5                 | 200                         | 0.3±0.03                  | R |
| UMK063 BJ472□P-F |               |                   |                             | B                | X5R              | 4700 p                    | ±10, ±20  | 5                 | 200                         | 0.3±0.03                  | R |
| UMK063 BJ682□P-F |               |                   |                             | B                | X5R              | 6800 p                    | ±10, ±20  | 5                 | 200                         | 0.3±0.03                  | R |
| UMK063 BJ103□P-F |               |                   |                             | B                | X5R              | 0.01 μ                    | ±10, ±20  | 5                 | 200                         | 0.3±0.03                  | R |
| GMK063 BJ104□P-F |               |                   | 35                          |                  | X5R              | 0.1 μ                     | ±10, ±20  | 10                | 150                         | 0.3±0.03                  | R |
| TMK063 BJ152□P-F |               |                   | 25                          | B                | X5R              | 1500 p                    | ±10, ±20  | 5                 | 200                         | 0.3±0.03                  | R |
| TMK063 BJ222□P-F |               |                   |                             | B                | X5R              | 2200 p                    | ±10, ±20  | 5                 | 200                         | 0.3±0.03                  | R |
| TMK063 BJ332□P-F |               |                   |                             | B                | X5R              | 3300 p                    | ±10, ±20  | 5                 | 200                         | 0.3±0.03                  | R |
| TMK063 BJ472□P-F |               |                   |                             | B                | X5R              | 4700 p                    | ±10, ±20  | 5                 | 200                         | 0.3±0.03                  | R |
| TMK063 BJ682□P-F |               | B                 |                             | X5R              | 6800 p           | ±10, ±20                  | 5         | 200               | 0.3±0.03                    | R                         |   |
| TMK063 BJ103□P-F |               | B                 |                             | X5R              | 0.01 μ           | ±10, ±20                  | 5         | 200               | 0.3±0.03                    | R                         |   |
| TMK063 BJ223□P-F |               | B                 |                             | X5R              | 0.022 μ          | ±10, ±20                  | 7.5       | 200               | 0.3±0.03                    | R                         |   |
| TMK063ABJ104□P-F |               |                   |                             |                  | X5R              | 0.1 μ                     | ±10, ±20  | 10                | 150                         | 0.3±0.05                  | R |
| EMK063 BJ152□P-F |               | 16                | B                           | X5R <sup>1</sup> | 1500 p           | ±10, ±20                  | 5         | 200               | 0.3±0.03                    | R                         |   |
| EMK063 BJ222□P-F |               |                   | B                           | X5R <sup>1</sup> | 2200 p           | ±10, ±20                  | 5         | 200               | 0.3±0.03                    | R                         |   |
| EMK063 BJ332□P-F |               |                   | B                           | X5R <sup>1</sup> | 3300 p           | ±10, ±20                  | 5         | 200               | 0.3±0.03                    | R                         |   |
| EMK063 BJ472□P-F |               |                   | B                           | X5R <sup>1</sup> | 4700 p           | ±10, ±20                  | 5         | 200               | 0.3±0.03                    | R                         |   |
| EMK063 BJ682□P-F |               |                   | B                           | X5R <sup>1</sup> | 6800 p           | ±10, ±20                  | 5         | 200               | 0.3±0.03                    | R                         |   |
| EMK063 BJ103□P-F |               |                   | B                           | X5R <sup>1</sup> | 0.01 μ           | ±10, ±20                  | 5         | 200               | 0.3±0.03                    | R                         |   |
| EMK063 BJ223□P-F |               |                   | B                           | X5R              | 0.022 μ          | ±10, ±20                  | 7.5       | 200               | 0.3±0.03                    | R                         |   |
| EMK063 BJ333□P-F |               |                   |                             | X5R              | 0.033 μ          | ±10, ±20                  | 7.5       | 150               | 0.3±0.03                    | R                         |   |
| EMK063 BJ473□P-F |               |                   |                             | X5R              | 0.047 μ          | ±10, ±20                  | 7.5       | 150               | 0.3±0.03                    | R                         |   |
| EMK063 BJ683□P-F |               |                   |                             | X5R              | 0.068 μ          | ±10, ±20                  | 10        | 150               | 0.3±0.03                    | R                         |   |
| EMK063 BJ104□P-F |               |                   |                             | X5R              | 0.1 μ            | ±10, ±20                  | 10        | 150               | 0.3±0.03                    | R                         |   |
| EMK063 BJ224□P-F |               |                   |                             | X5R              | 0.22 μ           | ±10, ±20                  | 10        | 150               | 0.3±0.03                    | R                         |   |
| EMK063BBJ474□PLF |               |                   | X5R                         | 0.47 μ           | ±10, ±20         | 10                        | 150       | 0.3±0.09          | R                           |                           |   |
| LMK063 BJ223□P-F |               | 10                | B                           | X5R              | 0.022 μ          | ±10, ±20                  | 7.5       | 150               | 0.3±0.03                    | R                         |   |
| LMK063 BJ333□P-F |               |                   |                             | X5R              | 0.033 μ          | ±10, ±20                  | 7.5       | 150               | 0.3±0.03                    | R                         |   |
| LMK063 BJ473□P-F |               |                   |                             | X5R              | 0.047 μ          | ±10, ±20                  | 7.5       | 150               | 0.3±0.03                    | R                         |   |
| LMK063 BJ683□P-F |               |                   |                             | X5R              | 0.068 μ          | ±10, ±20                  | 10        | 150               | 0.3±0.03                    | R                         |   |
| LMK063 BJ104□P-F |               |                   |                             | X5R              | 0.1 μ            | ±10, ±20                  | 10        | 150               | 0.3±0.03                    | R                         |   |
| LMK063 BJ224□P-F |               |                   |                             | X5R              | 0.22 μ           | ±10, ±20                  | 10        | 150               | 0.3±0.03                    | R                         |   |
| LMK063BBJ474□PLF |               |                   |                             | X5R              | 0.47 μ           | ±10, ±20                  | 10        | 150               | 0.3±0.09                    | R                         |   |
| LMK063BBJ105MPLF |               |                   |                             | X5R              | 1 μ              | ±20                       | 10        | 150               | 0.3±0.09                    | R                         |   |
| JMK063 BJ223□P-F |               | 6.3               | B                           | X5R              | 0.022 μ          | ±10, ±20                  | 7.5       | 200               | 0.3±0.03                    | R                         |   |
| JMK063 BJ333□P-F |               |                   |                             | X5R              | 0.033 μ          | ±10, ±20                  | 7.5       | 150               | 0.3±0.03                    | R                         |   |
| JMK063 BJ473□P-F |               |                   |                             | X5R              | 0.047 μ          | ±10, ±20                  | 7.5       | 150               | 0.3±0.03                    | R                         |   |
| JMK063 BJ683□P-F |               |                   |                             | X5R              | 0.068 μ          | ±10, ±20                  | 10        | 150               | 0.3±0.03                    | R                         |   |
| JMK063 BJ104□P-F |               |                   |                             | X5R              | 0.1 μ            | ±10, ±20                  | 10        | 150               | 0.3±0.03                    | R                         |   |
| JMK063 BJ224□P-F |               |                   |                             | X5R              | 0.22 μ           | ±10, ±20                  | 10        | 150               | 0.3±0.03                    | R                         |   |
| JMK063 BJ334MP-F |               |                   |                             | X5R              | 0.33 μ           | ±20                       | 10        | 150               | 0.3±0.03                    | R                         |   |
| JMK063 BJ474□P-F |               |                   |                             | X5R              | 0.47 μ           | ±10, ±20                  | 10        | 150               | 0.3±0.03                    | R                         |   |
| JMK063ABJ105□P-F |               |                   | X5R                         | 1 μ              | ±10, ±20         | 10                        | 150       | 0.3±0.05          | R                           |                           |   |
| AMK063 BJ224□P-F |               | 4                 |                             | X5R              | 0.22 μ           | ±10, ±20                  | 10        | 150               | 0.3±0.03                    | R                         |   |
| AMK063 BJ334MP-F |               |                   |                             | X5R              | 0.33 μ           | ±20                       | 10        | 150               | 0.3±0.03                    | R                         |   |
| AMK063 BJ474□P-F |               |                   |                             | X5R              | 0.47 μ           | ±10, ±20                  | 10        | 150               | 0.3±0.03                    | R                         |   |
| AMK063ABJ105□P-F |               |                   |                             | X5R              | 1 μ              | ±10, ±20                  | 10        | 150               | 0.3±0.05                    | R                         |   |

[Temperature Characteristic C6 : X6S(-55~+105°C)] 0.3mm thickness (P)

| Part number 1    | Part number 2 | Rated voltage [V] | Temperature characteristics |     | Capacitance [F] | Capacitance tolerance [%] | tan δ [%] | HTLT              | Thickness <sup>3</sup> [mm] | Soldering R:Reflow W:Wave |   |
|------------------|---------------|-------------------|-----------------------------|-----|-----------------|---------------------------|-----------|-------------------|-----------------------------|---------------------------|---|
|                  |               |                   |                             |     |                 |                           |           | Rated voltage x % |                             |                           |   |
| TMK063 C6104□P-F |               | 25                |                             | X6S | 0.1 μ           | ±10, ±20                  | 10        | 150               | 0.3±0.03                    | R                         |   |
| EMK063AC6104□P-F |               | 16                |                             | X6S | 0.1 μ           | ±10, ±20                  | 10        | 150               | 0.3±0.05                    | R                         |   |
| LMK063 C6333□P-F |               | 10                |                             | X6S | 0.033 μ         | ±10, ±20                  | 7.5       | 150               | 0.3±0.03                    | R                         |   |
| LMK063 C6473□P-F |               |                   |                             | X6S | 0.047 μ         | ±10, ±20                  | 7.5       | 150               | 0.3±0.03                    | R                         |   |
| LMK063 C6683□P-F |               |                   |                             | X6S | 0.068 μ         | ±10, ±20                  | 10        | 150               | 0.3±0.03                    | R                         |   |
| LMK063 C6104□P-F |               |                   |                             | X6S | 0.1 μ           | ±10, ±20                  | 10        | 150               | 0.3±0.03                    | R                         |   |
| LMK063 C6224□P-F |               |                   |                             | X6S | 0.22 μ          | ±10, ±20                  | 10        | 150               | 0.3±0.03                    | R                         |   |
| LMK063BC6474□PLF |               |                   |                             | X6S | 0.47 μ          | ±10, ±20                  | 10        | 150               | 0.3±0.09                    | R                         |   |
| JMK063 C6223□P-F |               |                   |                             | X6S | 0.022 μ         | ±10, ±20                  | 7.5       | 200               | 0.3±0.03                    | R                         |   |
| JMK063 C6333□P-F |               |                   |                             | X6S | 0.033 μ         | ±10, ±20                  | 7.5       | 150               | 0.3±0.03                    | R                         |   |
| JMK063 C6473□P-F |               | 6.3               |                             | X6S | 0.047 μ         | ±10, ±20                  | 7.5       | 150               | 0.3±0.03                    | R                         |   |
| JMK063 C6683□P-F |               |                   |                             | X6S | 0.068 μ         | ±10, ±20                  | 10        | 150               | 0.3±0.03                    | R                         |   |
| JMK063 C6104□P-F |               |                   |                             | X6S | 0.1 μ           | ±10, ±20                  | 10        | 150               | 0.3±0.03                    | R                         |   |
| JMK063 C6224□P-F |               |                   |                             | X6S | 0.22 μ          | ±10, ±20                  | 10        | 150               | 0.3±0.03                    | R                         |   |
| JMK063BC6474□PLF |               |                   |                             | X6S | 0.47 μ          | ±10, ±20                  | 10        | 150               | 0.3±0.09                    | R                         |   |
| JMK063BC6105MP-F |               |                   |                             | X6S | 1 μ             | ±20                       | 10        | 150               | 0.3±0.09                    | R                         |   |
| AMK063 C6474□P-F |               |                   | 4                           |     | X6S             | 0.47 μ                    | ±10, ±20  | 10                | 150                         | 0.3±0.03                  | R |
| AMK063AC6105□P-F |               |                   |                             |     | X6S             | 1 μ                       | ±10, ±20  | 10                | 150                         | 0.3±0.05                  | R |

► This catalog contains the typical specification only due to the limitation of space. When you consider the purchase of our products, please check our product specification sheets. For details of each product (characteristics graph, reliability information, precautions for use, and so on), see our website (<http://www.ty-top.com/>).

【Temperature Characteristic B7 : X7R(-55~+125°C)】 0.3mm thickness (P)

| Part number 1    | Part number 2 | Rated voltage [V] | Temperature characteristics | Capacitance [F] | Capacitance tolerance [%] | tan δ [%] | HTLT              | Thickness*3 [mm] | Soldering R:Reflow W:Wave |   |
|------------------|---------------|-------------------|-----------------------------|-----------------|---------------------------|-----------|-------------------|------------------|---------------------------|---|
|                  |               |                   |                             |                 |                           |           | Rated voltage x % |                  |                           |   |
| UMK063 B7101□P-F |               | 50                | X7R                         | 100 p           | ±10, ±20                  | 3.5       | 200               | 0.3±0.03         | R                         |   |
| UMK063 B7151□P-F |               |                   | X7R                         | 150 p           | ±10, ±20                  | 3.5       | 200               | 0.3±0.03         | R                         |   |
| UMK063 B7221□P-F |               |                   | X7R                         | 220 p           | ±10, ±20                  | 3.5       | 200               | 0.3±0.03         | R                         |   |
| UMK063 B7331□P-F |               |                   | X7R                         | 330 p           | ±10, ±20                  | 3.5       | 200               | 0.3±0.03         | R                         |   |
| UMK063 B7471□P-F |               |                   | X7R                         | 470 p           | ±10, ±20                  | 3.5       | 200               | 0.3±0.03         | R                         |   |
| UMK063 B7681□P-F |               |                   | X7R                         | 680 p           | ±10, ±20                  | 3.5       | 200               | 0.3±0.03         | R                         |   |
| UMK063 B7102□P-F |               |                   | X7R                         | 1000 p          | ±10, ±20                  | 3.5       | 200               | 0.3±0.03         | R                         |   |
| TMK063 B7152□P-F |               |                   | 25                          | X7R             | 1500 p                    | ±10, ±20  | 5                 | 200              | 0.3±0.03                  | R |
| TMK063 B7222□P-F |               |                   |                             | X7R             | 2200 p                    | ±10, ±20  | 5                 | 200              | 0.3±0.03                  | R |
| TMK063 B7332□P-F |               |                   |                             | X7R             | 3300 p                    | ±10, ±20  | 5                 | 200              | 0.3±0.03                  | R |
| TMK063 B7472□P-F |               |                   |                             | X7R             | 4700 p                    | ±10, ±20  | 5                 | 200              | 0.3±0.03                  | R |
| TMK063 B7682□P-F |               |                   |                             | X7R             | 6800 p                    | ±10, ±20  | 5                 | 200              | 0.3±0.03                  | R |
| TMK063 B7103□P-F |               | X7R               |                             | 0.01 μ          | ±10, ±20                  | 5         | 200               | 0.3±0.03         | R                         |   |
| EMK063 B7152□P-F |               | 16                |                             | X7R             | 1500 p                    | ±10, ±20  | 5                 | 200              | 0.3±0.03                  | R |
| EMK063 B7222□P-F |               |                   |                             | X7R             | 2200 p                    | ±10, ±20  | 5                 | 200              | 0.3±0.03                  | R |
| EMK063 B7332□P-F |               |                   |                             | X7R             | 3300 p                    | ±10, ±20  | 5                 | 200              | 0.3±0.03                  | R |
| EMK063 B7472□P-F |               |                   |                             | X7R             | 4700 p                    | ±10, ±20  | 5                 | 200              | 0.3±0.03                  | R |
| EMK063 B7682□P-F |               |                   |                             | X7R             | 6800 p                    | ±10, ±20  | 5                 | 200              | 0.3±0.03                  | R |
| EMK063 B7103□P-F |               |                   |                             | X7R             | 0.01 μ                    | ±10, ±20  | 5                 | 200              | 0.3±0.03                  | R |
| EMK063 B7223□P-F |               |                   | X7R                         | 0.022 μ         | ±10, ±20                  | 7.5       | 150               | 0.3±0.03         | R                         |   |

105TYPE

【Temperature Characteristic BJ : B(-25~+85°C)/X5R(-55~+85°C)】 0.5mm thickness (V)

| Part number 1    | Part number 2     | Rated voltage [V] | Temperature characteristics | Capacitance [F]     | Capacitance tolerance [%] | tan δ [%] | HTLT              | Thickness*3 [mm] | Soldering R:Reflow W:Wave |   |
|------------------|-------------------|-------------------|-----------------------------|---------------------|---------------------------|-----------|-------------------|------------------|---------------------------|---|
|                  |                   |                   |                             |                     |                           |           | Rated voltage x % |                  |                           |   |
| UMK105 BJ221□V-F |                   | 50                | B X5R <sup>+1</sup>         | 220 p               | ±10, ±20                  | 2.5       | 200               | 0.5±0.05         | R                         |   |
| UMK105 BJ331□V-F |                   |                   | B X5R <sup>+1</sup>         | 330 p               | ±10, ±20                  | 2.5       | 200               | 0.5±0.05         | R                         |   |
| UMK105 BJ471□V-F |                   |                   | B X5R <sup>+1</sup>         | 470 p               | ±10, ±20                  | 2.5       | 200               | 0.5±0.05         | R                         |   |
| UMK105 BJ681□V-F |                   |                   | B X5R <sup>+1</sup>         | 680 p               | ±10, ±20                  | 2.5       | 200               | 0.5±0.05         | R                         |   |
| UMK105 BJ102□V-F |                   |                   | B X5R <sup>+1</sup>         | 1000 p              | ±10, ±20                  | 2.5       | 200               | 0.5±0.05         | R                         |   |
| UMK105 BJ152□V-F |                   |                   | B X5R <sup>+1</sup>         | 1500 p              | ±10, ±20                  | 2.5       | 200               | 0.5±0.05         | R                         |   |
| UMK105 BJ222□V-F |                   |                   | B X5R <sup>+1</sup>         | 2200 p              | ±10, ±20                  | 2.5       | 200               | 0.5±0.05         | R                         |   |
| UMK105 BJ332□V-F |                   |                   | B X5R <sup>+1</sup>         | 3300 p              | ±10, ±20                  | 2.5       | 200               | 0.5±0.05         | R                         |   |
| UMK105 BJ472□V-F |                   |                   | B X5R <sup>+1</sup>         | 4700 p              | ±10, ±20                  | 2.5       | 200               | 0.5±0.05         | R                         |   |
| UMK105 BJ682□V-F |                   |                   | B X5R <sup>+1</sup>         | 6800 p              | ±10, ±20                  | 2.5       | 150               | 0.5±0.05         | R                         |   |
| UMK105 BJ103□V-F |                   |                   | B X5R <sup>+1</sup>         | 0.01 μ              | ±10, ±20                  | 3.5       | 200               | 0.5±0.05         | R                         |   |
| UMK105 BJ104□V-F |                   |                   | X5R                         | 0.1 μ               | ±10, ±20                  | 10        | 150               | 0.5±0.05         | R                         |   |
| UMK105 BJ224□V-F |                   |                   | X5R                         | 0.22 μ              | ±10, ±20                  | 10        | 150               | 0.5±0.05         | R                         |   |
| UMK105ABJ474□V-F |                   |                   | X5R                         | 0.47 μ              | ±10, ±20                  | 10        | 150               | 0.5±0.10         | R                         |   |
| UMK105CBJ105MV-F |                   |                   | X5R                         | 1 μ                 | ±20                       | 10        | 150               | 0.5+0.20/-0      | R                         |   |
| GMK105 BJ104□V-F |                   |                   | 35                          | B X5R               | 0.1 μ                     | ±10, ±20  | 5                 | 150              | 0.5±0.05                  | R |
| GMK105ABJ105□V-F |                   |                   |                             | X5R                 | 1 μ                       | ±10, ±20  | 10                | 150              | 0.5±0.10                  | R |
| TMK105 BJ153□V-F |                   |                   |                             | B X5R <sup>+1</sup> | 0.015 μ                   | ±10, ±20  | 3.5               | 200              | 0.5±0.05                  | R |
| TMK105 BJ223□V-F |                   |                   |                             | B X5R <sup>+1</sup> | 0.022 μ                   | ±10, ±20  | 3.5               | 200              | 0.5±0.05                  | R |
| TMK105 BJ333□V-F |                   |                   |                             | B X5R <sup>+1</sup> | 0.033 μ                   | ±10, ±20  | 3.5               | 150              | 0.5±0.05                  | R |
| TMK105 BJ473□V-F |                   |                   |                             | B X5R <sup>+1</sup> | 0.047 μ                   | ±10, ±20  | 3.5               | 150              | 0.5±0.05                  | R |
| TMK105 BJ104□V-F |                   |                   |                             | B X5R               | 0.1 μ                     | ±10, ±20  | 5                 | 150              | 0.5±0.05                  | R |
| TMK105 BJ224□V-F |                   |                   |                             | X5R                 | 0.22 μ                    | ±10, ±20  | 10                | 200              | 0.5±0.05                  | R |
| TMK105ABJ474□V-F |                   |                   |                             | X5R                 | 0.47 μ                    | ±10, ±20  | 10                | 200              | 0.5±0.10                  | R |
| TMK105 BJ105□V-F |                   | X5R               |                             | 1 μ                 | ±10, ±20                  | 10        | 150               | 0.5±0.05         | R                         |   |
| TMK105CBJ225□V-F |                   | X5R               |                             | 2.2 μ               | ±10, ±20                  | 10        | 150               | 0.5+0.20/-0      | R                         |   |
| EMK105 BJ153□V-F |                   | 16                |                             | B X5R <sup>+1</sup> | 0.015 μ                   | ±10, ±20  | 3.5               | 200              | 0.5±0.05                  | R |
| EMK105 BJ223□V-F |                   |                   | B X5R <sup>+1</sup>         | 0.022 μ             | ±10, ±20                  | 3.5       | 200               | 0.5±0.05         | R                         |   |
| EMK105 BJ333□V-F |                   |                   | B X5R <sup>+1</sup>         | 0.033 μ             | ±10, ±20                  | 3.5       | 200               | 0.5±0.05         | R                         |   |
| EMK105 BJ473□V-F |                   |                   | B X5R <sup>+1</sup>         | 0.047 μ             | ±10, ±20                  | 3.5       | 200               | 0.5±0.05         | R                         |   |
| EMK105 BJ683□V-F |                   |                   | B X5R                       | 0.068 μ             | ±10, ±20                  | 5         | 200               | 0.5±0.05         | R                         |   |
| EMK105 BJ104□V-F |                   |                   | X5R <sup>+1</sup>           | 0.1 μ               | ±10, ±20                  | 5         | 150               | 0.5±0.05         | R                         |   |
| EMK105 BJ224□V-F |                   |                   | X5R                         | 0.22 μ              | ±10, ±20                  | 5         | 150               | 0.5±0.05         | R                         |   |
| EMK105ABJ474□V-F |                   |                   | X5R                         | 0.47 μ              | ±10, ±20                  | 10        | 200               | 0.5±0.10         | R                         |   |
| EMK105 BJ105□V-F |                   |                   | X5R                         | 1 μ                 | ±10, ±20                  | 10        | 150               | 0.5±0.05         | R                         |   |
| EMK105ABJ225□V-F |                   |                   | X5R                         | 2.2 μ               | ±10, ±20                  | 10        | 150               | 0.5±0.10         | R                         |   |
| LKM105 BJ104□V-F |                   |                   | 10                          | X5R                 | 0.1 μ                     | ±10, ±20  | 5                 | 200              | 0.5±0.05                  | R |
| LKM105 BJ224□V-F |                   |                   |                             | X5R                 | 0.22 μ                    | ±10, ±20  | 5                 | 150              | 0.5±0.05                  | R |
| LKM105 BJ474□V-F |                   | X5R               |                             | 0.47 μ              | ±10, ±20                  | 10        | 150               | 0.5±0.05         | R                         |   |
| LKM105 BJ105□V-F |                   | X5R               |                             | 1 μ                 | ±10, ±20                  | 10        | 150               | 0.5±0.05         | R                         |   |
| LKM105 BJ225□V-F |                   | X5R               |                             | 2.2 μ               | ±10, ±20                  | 10        | 150               | 0.5±0.05         | R                         |   |
| LKM105BBJ475MVF  |                   | X5R               |                             | 4.7 μ               | ±20                       | 10        | 150               | 0.5+0.15/-0.05   | R                         |   |
| JMK105 BJ224□V-F |                   | 6.3               |                             | X5R                 | 0.22 μ                    | ±10, ±20  | 5                 | 150              | 0.5±0.05                  | R |
| JMK105 BJ474□V-F |                   |                   |                             | X5R                 | 0.47 μ                    | ±10, ±20  | 10                | 150              | 0.5±0.05                  | R |
| JMK105 BJ105□V-F |                   |                   |                             | X5R                 | 1 μ                       | ±10, ±20  | 10                | 150              | 0.5±0.05                  | R |
| JMK105 BJ225□V-F |                   |                   |                             | X5R                 | 2.2 μ                     | ±10, ±20  | 10                | 150              | 0.5±0.05                  | R |
| JMK105BBJ475MV-F | JMK105 BJ475MV-FD |                   |                             | X5R                 | 4.7 μ                     | ±20       | 10                | 150              | 0.5+0.15/-0.05            | R |
| JMK105CBJ106MV-F |                   |                   |                             | X5R                 | 10 μ                      | ±20       | 10                | 150              | 0.5+0.20/-0               | R |
| AMK105ABJ475MV-F | AMK105 BJ475MV-F  |                   | X5R                         | 4.7 μ               | ±20                       | 10        | 150               | 0.5±0.10         | R                         |   |
| AMK105CBJ106MV-F |                   |                   | X5R                         | 10 μ                | ±20                       | 10        | 150               | 0.5+0.20/-0      | R                         |   |
| AMK105EBJ226MV-F |                   |                   | X5R                         | 22 μ                | ±20                       | 20        | 150               | 0.5+0.30/-0      | R                         |   |

▶ This catalog contains the typical specification only due to the limitation of space. When you consider the purchase of our products, please check our product specification sheets. For details of each product (characteristics graph, reliability information, precautions for use, and so on), see our website (<http://www.ty-top.com/>).

## 【Temperature Characteristic BJ : B (-25~+85°C)/X5R(-55~+85°C)】 0.3mm thickness (P)

| Part number 1    | Part number 2 | Rated voltage [V] | Temperature characteristics |     | Capacitance [F] | Capacitance tolerance [%] | tan δ [%] | HTLT              | Thickness <sup>*3</sup> [mm] | Soldering R:Reflow W:Wave |
|------------------|---------------|-------------------|-----------------------------|-----|-----------------|---------------------------|-----------|-------------------|------------------------------|---------------------------|
|                  |               |                   |                             |     |                 |                           |           | Rated voltage x % |                              |                           |
| UMK105 BJ104□P-F |               | 50                | B                           | X5R | 0.1 μ           | ±10, ±20                  | 10        | 150               | 0.3±0.03                     | R                         |
| TMK105 BJ103□P-F |               |                   |                             |     | 0.01 μ          | ±10, ±20                  | 5         | 150               | 0.3±0.03                     | R                         |
| TMK105 BJ104□P-F |               | 25                |                             | X5R | 0.1 μ           | ±10, ±20                  | 10        | 150               | 0.3±0.03                     | R                         |
| TMK105 BJ224□P-F |               |                   |                             |     | 0.22 μ          | ±10, ±20                  | 10        | 150               | 0.3±0.03                     | R                         |
| TMK105 BJ474□P-F |               |                   |                             |     | 0.47 μ          | ±10, ±20                  | 10        | 150               | 0.3±0.03                     | R                         |
| EMK105 BJ474□P-F |               |                   |                             |     | 0.47 μ          | ±10, ±20                  | 10        | 150               | 0.3±0.03                     | R                         |
| EMK105 BJ474□P-F |               | 16                |                             | X5R | 0.47 μ          | ±10, ±20                  | 10        | 150               | 0.3±0.03                     | R                         |
| LMK105 BJ105□PLF |               | 10                |                             | X5R | 1 μ             | ±10, ±20                  | 10        | 150               | 0.3±0.03                     | R                         |
| JMK105 BJ105□P-F |               | 6.3               |                             | X5R | 1 μ             | ±10, ±20                  | 10        | 150               | 0.3±0.03                     | R                         |
| AMK105 BJ225MP-F |               | 4                 |                             | X5R | 2.2 μ           | ±20                       | 10        | 150               | 0.3±0.03                     | R                         |

## 【Temperature Characteristic BJ : X5R(-55~+85°C)】 0.2mm thickness (C)

| Part number 1    | Part number 2 | Rated voltage [V] | Temperature characteristics |     | Capacitance [F] | Capacitance tolerance [%] | tan δ [%] | HTLT              | Thickness <sup>*3</sup> [mm] | Soldering R:Reflow W:Wave |
|------------------|---------------|-------------------|-----------------------------|-----|-----------------|---------------------------|-----------|-------------------|------------------------------|---------------------------|
|                  |               |                   |                             |     |                 |                           |           | Rated voltage x % |                              |                           |
| LMK105 BJ104□C-F |               | 10                |                             | X5R | 0.1 μ           | ±10, ±20                  | 10        | 150               | 0.2±0.02                     | R                         |
| JMK105 BJ224□C-F |               | 6.3               |                             | X5R | 0.22 μ          | ±10, ±20                  | 10        | 150               | 0.2±0.02                     | R                         |
| LMK105 BJ474□C-F |               |                   |                             |     | 0.47 μ          | ±10, ±20                  | 10        | 150               | 0.2±0.02                     | R                         |
| JMK105 BJ105MC-F |               |                   |                             |     | 1 μ             | ±20                       | 10        | 150               | 0.2±0.02                     | R                         |

## 【Temperature Characteristic BJ : X5R(-55~+85°C)】 0.18mm thickness (E)

| Part number 1    | Part number 2 | Rated voltage [V] | Temperature characteristics |     | Capacitance [F] | Capacitance tolerance [%] | tan δ [%] | HTLT              | Thickness <sup>*3</sup> [mm] | Soldering R:Reflow W:Wave |
|------------------|---------------|-------------------|-----------------------------|-----|-----------------|---------------------------|-----------|-------------------|------------------------------|---------------------------|
|                  |               |                   |                             |     |                 |                           |           | Rated voltage x % |                              |                           |
| LMK105 BJ104□E-R |               | 10                |                             | X5R | 0.1 μ           | ±10, ±20                  | 10        | 150               | 0.18±0.02                    | R                         |
| JMK105 BJ224□E-R |               | 6.3               |                             | X5R | 0.22 μ          | ±10, ±20                  | 10        | 150               | 0.18±0.02                    | R                         |
| JMK105 BJ474□E-R |               |                   |                             |     | 0.47 μ          | ±10, ±20                  | 10        | 150               | 0.18±0.02                    | R                         |
| AMK105 BJ105ME-R |               | 4                 |                             | X5R | 1 μ             | ±20                       | 10        | 150               | 0.18±0.02                    | R                         |

## 【Temperature Characteristic BJ : X5R(-55~+85°C)】 0.13mm thickness (H)

| Part number 1    | Part number 2 | Rated voltage [V] | Temperature characteristics |     | Capacitance [F] | Capacitance tolerance [%] | tan δ [%] | HTLT              | Thickness <sup>*3</sup> [mm] | Soldering R:Reflow W:Wave |
|------------------|---------------|-------------------|-----------------------------|-----|-----------------|---------------------------|-----------|-------------------|------------------------------|---------------------------|
|                  |               |                   |                             |     |                 |                           |           | Rated voltage x % |                              |                           |
| LMK105 BJ104MH-R |               | 10                |                             | X5R | 0.1 μ           | ±20                       | 10        | 150               | 0.13±0.02                    | R                         |
| JMK105 BJ224MH-R |               | 6.3               |                             | X5R | 0.22 μ          | ±20                       | 10        | 150               | 0.13±0.02                    | R                         |
| AMK105 BJ474MH-R |               | 4                 |                             | X5R | 0.47 μ          | ±20                       | 10        | 150               | 0.13±0.02                    | R                         |

## 【Temperature Characteristic C6 : X6S(-55~+105°C)】 0.5mm thickness (V)

| Part number 1    | Part number 2 | Rated voltage [V] | Temperature characteristics |     | Capacitance [F] | Capacitance tolerance [%] | tan δ [%] | HTLT              | Thickness <sup>*3</sup> [mm] | Soldering R:Reflow W:Wave |
|------------------|---------------|-------------------|-----------------------------|-----|-----------------|---------------------------|-----------|-------------------|------------------------------|---------------------------|
|                  |               |                   |                             |     |                 |                           |           | Rated voltage x % |                              |                           |
| GMK105CC6105MV-F |               | 35                |                             | X6S | 1 μ             | ±20                       | 10        | 150               | 0.5+0.20/-0                  | R                         |
| TMK105AC6105□V-F |               | 25                |                             | X6S | 1 μ             | ±10, ±20                  | 10        | 150               | 0.5±0.10                     | R                         |
| EMK105 C6105□V-F |               | 16                |                             | X6S | 1 μ             | ±10, ±20                  | 10        | 150               | 0.5±0.05                     | R                         |
| EMK105CC6225MV-F |               |                   |                             |     | 2.2 μ           | ±20                       | 10        | 150               | 0.5+0.20/-0                  | R                         |
| LMK105 C6105□V-F |               | 10                |                             | X6S | 1 μ             | ±10, ±20                  | 10        | 200               | 0.5±0.05                     | R                         |
| LMK105AC6225MV-F |               |                   |                             |     | 2.2 μ           | ±20                       | 10        | 150               | 0.5±0.10                     | R                         |
| JMK105 C6105□V-F |               |                   |                             |     | 1 μ             | ±10, ±20                  | 10        | 150               | 0.5±0.05                     | R                         |
| JMK105 C6225MV-F |               |                   |                             |     | 2.2 μ           | ±20                       | 10        | 150               | 0.5±0.05                     | R                         |
| JMK105BC6475MV-F |               | 6.3               |                             | X6S | 2.2 μ           | ±20                       | 10        | 150               | 0.5±0.05                     | R                         |
| JMK105BC6475MV-F |               |                   |                             |     | 4.7 μ           | ±20                       | 10        | 150               | 0.5+0.15/-0.05               | R                         |
| AMK105BC6475MV-F |               | 4                 |                             | X6S | 4.7 μ           | ±20                       | 10        | 200               | 0.5+0.15/-0.05               | R                         |

▶ This catalog contains the typical specification only due to the limitation of space. When you consider the purchase of our products, please check our product specification sheets. For details of each product (characteristics graph, reliability information, precautions for use, and so on), see our website (<http://www.ty-top.com/>).



【Temperature Characteristic B7 : X7R(-55~+125°C)】 0.5mm thickness (V)

| Part number 1     | Part number 2 | Rated voltage [V] | Temperature characteristics | Capacitance [F] | Capacitance tolerance [%] | tan δ [%] | HTLT              | Thickness*3 [mm] | Soldering R:Reflow W:Wave |
|-------------------|---------------|-------------------|-----------------------------|-----------------|---------------------------|-----------|-------------------|------------------|---------------------------|
|                   |               |                   |                             |                 |                           |           | Rated voltage x % |                  |                           |
| UMK105 B7221□V-F  |               | 50                | X7R                         | 220 p           | ±10, ±20                  | 2.5       | 200               | 0.5±0.05         | R                         |
| UMK105 B7331□V-F  |               |                   | X7R                         | 330 p           | ±10, ±20                  | 2.5       | 200               | 0.5±0.05         | R                         |
| UMK105 B7471□V-F  |               |                   | X7R                         | 470 p           | ±10, ±20                  | 2.5       | 200               | 0.5±0.05         | R                         |
| UMK105 B7681□V-F  |               |                   | X7R                         | 680 p           | ±10, ±20                  | 2.5       | 200               | 0.5±0.05         | R                         |
| UMK105 B7102□V-F  |               |                   | X7R                         | 1000 p          | ±10, ±20                  | 2.5       | 200               | 0.5±0.05         | R                         |
| UMK105 B7152□V-F  |               |                   | X7R                         | 1500 p          | ±10, ±20                  | 2.5       | 200               | 0.5±0.05         | R                         |
| UMK105 B7222□V-F  |               |                   | X7R                         | 2200 p          | ±10, ±20                  | 2.5       | 200               | 0.5±0.05         | R                         |
| UMK105 B7332□V-F  |               |                   | X7R                         | 3300 p          | ±10, ±20                  | 2.5       | 200               | 0.5±0.05         | R                         |
| UMK105 B7472□V-F  |               |                   | X7R                         | 4700 p          | ±10, ±20                  | 2.5       | 150               | 0.5±0.05         | R                         |
| UMK105 B7682□V-F  |               |                   | X7R                         | 6800 p          | ±10, ±20                  | 2.5       | 150               | 0.5±0.05         | R                         |
| UMK105 B7103□V-F  |               |                   | X7R                         | 0.01 μ          | ±10, ±20                  | 3.5       | 150               | 0.5±0.05         | R                         |
| UMK105 B7223□V-FR |               |                   | X7R                         | 0.022 μ         | ±10, ±20                  | 10        | 200               | 0.5±0.05         | R                         |
| UMK105 B7473□V-FR |               |                   | X7R                         | 0.047 μ         | ±10, ±20                  | 10        | 200               | 0.5±0.05         | R                         |
| UMK105 B7104□V-FR |               |                   | X7R                         | 0.1 μ           | ±10, ±20                  | 10        | 150               | 0.5±0.05         | R                         |
| TMK105 B7152□V-F  |               |                   | X7R                         | 1500 p          | ±10, ±20                  | 2.5       | 200               | 0.5±0.05         | R                         |
| TMK105 B7222□V-F  |               |                   | X7R                         | 2200 p          | ±10, ±20                  | 2.5       | 200               | 0.5±0.05         | R                         |
| TMK105 B7332□V-F  |               |                   | X7R                         | 3300 p          | ±10, ±20                  | 2.5       | 200               | 0.5±0.05         | R                         |
| TMK105 B7472□V-F  |               |                   | X7R                         | 4700 p          | ±10, ±20                  | 2.5       | 200               | 0.5±0.05         | R                         |
| TMK105 B7682□V-F  |               |                   | X7R                         | 6800 p          | ±10, ±20                  | 2.5       | 200               | 0.5±0.05         | R                         |
| TMK105 B7103□V-F  |               |                   | X7R                         | 0.01 μ          | ±10, ±20                  | 3.5       | 200               | 0.5±0.05         | R                         |
| TMK105 B7223□V-F  |               | X7R               | 0.022 μ                     | ±10, ±20        | 3.5                       | 150       | 0.5±0.05          | R                |                           |
| TMK105 B7473□V-F  |               | X7R               | 0.047 μ                     | ±10, ±20        | 3.5                       | 150       | 0.5±0.05          | R                |                           |
| TMK105 B7104□V-FR |               | X7R               | 0.1 μ                       | ±10, ±20        | 10                        | 200       | 0.5±0.05          | R                |                           |
| TMK105 B7224□V-FR |               | X7R               | 0.22 μ                      | ±10, ±20        | 10                        | 150       | 0.5±0.05          | R                |                           |
| EMK105 B7223□V-F  |               | X7R               | 0.022 μ                     | ±10, ±20        | 3.5                       | 200       | 0.5±0.05          | R                |                           |
| EMK105 B7473□V-F  |               | X7R               | 0.047 μ                     | ±10, ±20        | 3.5                       | 200       | 0.5±0.05          | R                |                           |
| EMK105 B7104□V-F  |               | X7R               | 0.1 μ                       | ±10, ±20        | 5                         | 150       | 0.5±0.05          | R                |                           |
| EMK105 B7224□V-FR |               | X7R               | 0.22 μ                      | ±10, ±20        | 10                        | 150       | 0.5±0.05          | R                |                           |
| LMK105 B7223□V-F  |               | X7R               | 0.022 μ                     | ±10, ±20        | 3.5                       | 200       | 0.5±0.05          | R                |                           |
| LMK105 B7473□V-F  |               | X7R               | 0.047 μ                     | ±10, ±20        | 3.5                       | 200       | 0.5±0.05          | R                |                           |
| LMK105 B7104□V-F  |               | X7R               | 0.1 μ                       | ±10, ±20        | 5                         | 150       | 0.5±0.05          | R                |                           |
| LMK105 B7224□V-FR |               | X7R               | 0.22 μ                      | ±10, ±20        | 10                        | 150       | 0.5±0.05          | R                |                           |
| LMK105 B7474□V-F  |               | X7R               | 0.47 μ                      | ±10, ±20        | 10                        | 150       | 0.5±0.05          | R                |                           |
| JMK105 B7224□V-F  |               | X7R               | 0.22 μ                      | ±10, ±20        | 5                         | 150       | 0.5±0.05          | R                |                           |
| JMK105 B7474□V-F  |               | X7R               | 0.47 μ                      | ±10, ±20        | 10                        | 150       | 0.5±0.05          | R                |                           |

107TYPE

【Temperature Characteristic BJ : B(-25~+85°C)/X5R(-55~+85°C)】 0.8mm thickness (A)

| Part number 1     | Part number 2     | Rated voltage [V] | Temperature characteristics | Capacitance [F] | Capacitance tolerance [%] | tan δ [%] | HTLT              | Thickness*3 [mm] | Soldering R:Reflow W:Wave |
|-------------------|-------------------|-------------------|-----------------------------|-----------------|---------------------------|-----------|-------------------|------------------|---------------------------|
|                   |                   |                   |                             |                 |                           |           | Rated voltage x % |                  |                           |
| UMK107ABJ474□A-T  | UMK107 BJ474□A-TD | 50                | X5R                         | 0.47 μ          | ±10, ±20                  | 10        | 150               | 0.8+0.15/-0.05   | R                         |
| UMK107 BJ105□A-T  |                   |                   | X5R                         | 1 μ             | ±10, ±20                  | 10        | 150               | 0.8±0.10         | R                         |
| UMK107BBJ225□A-T  |                   | X5R               | 2.2 μ                       | ±10, ±20        | 10                        | 150       | 0.8+0.20/-0       | R                |                           |
| GMK107 BJ105□A-T  |                   | 35                | X5R                         | 1 μ             | ±10, ±20                  | 5         | 150               | 0.8±0.10         | R                         |
| TMK107 BJ224□A-T  |                   |                   | B X5R                       | 0.22 μ          | ±10, ±20                  | 3.5       | 200               | 0.8±0.10         | R/W                       |
| TMK107 BJ474□A-T  |                   | B X5R             | 0.47 μ                      | ±10, ±20        | 3.5                       | 150       | 0.8±0.10          | R                |                           |
| TMK107 BJ105□A-T  |                   | B X5R             | 1 μ                         | ±10, ±20        | 5                         | 150       | 0.8±0.10          | R                |                           |
| TMK107ABJ225□A-T  | TMK107 BJ225□A-TD | 25                | X5R                         | 2.2 μ           | ±10, ±20                  | 10        | 150               | 0.8+0.15/-0.05   | R                         |
| TMK107BBJ475□A-T  |                   |                   | X5R                         | 4.7 μ           | ±10, ±20                  | 10        | 150               | 0.8+0.20/-0      | R                         |
| TMK107BBJ106MA-T  |                   | X5R               | 10 μ                        | ±20             | 10                        | 150       | 0.8+0.20/-0       | R                |                           |
| EMK107 BJ224□A-T  |                   | 16                | B X5R <sup>1</sup>          | 0.22 μ          | ±10, ±20                  | 3.5       | 200               | 0.8±0.10         | R/W                       |
| EMK107 BJ474□A-T  |                   |                   | B X5R <sup>1</sup>          | 0.47 μ          | ±10, ±20                  | 3.5       | 200               | 0.8±0.10         | R                         |
| EMK107 BJ105□A-T  |                   | X5R <sup>1</sup>  | 1 μ                         | ±10, ±20        | 5                         | 150       | 0.8±0.10          | R                |                           |
| EMK107 BJ225□A-T  |                   | X5R               | 2.2 μ                       | ±10, ±20        | 10                        | 150       | 0.8±0.10          | R                |                           |
| EMK107ABJ475□A-T  | EMK107 BJ475□A-TD | 10                | X5R                         | 4.7 μ           | ±10, ±20                  | 10        | 150               | 0.8+0.15/-0.05   | R                         |
| EMK107BBJ106MA-T  |                   |                   | X5R                         | 10 μ            | ±20                       | 10        | 150               | 0.8+0.20/-0      | R                         |
| LMK107 BJ224□A-T  |                   | 10                | B X5R <sup>1</sup>          | 0.22 μ          | ±10, ±20                  | 3.5       | 200               | 0.8±0.10         | R/W                       |
| LMK107 BJ474□A-T  |                   |                   | B X5R <sup>1</sup>          | 0.47 μ          | ±10, ±20                  | 3.5       | 200               | 0.8±0.10         | R                         |
| LMK107 BJ105□A-T  |                   | X5R <sup>1</sup>  | 1 μ                         | ±10, ±20        | 5                         | 200       | 0.8±0.10          | R                |                           |
| LMK107 BJ225□A-T  |                   | X5R               | 2.2 μ                       | ±10, ±20        | 10                        | 150       | 0.8±0.10          | R                |                           |
| LMK107 BJ475□A-T  |                   | X5R               | 4.7 μ                       | ±10, ±20        | 10                        | 150       | 0.8±0.10          | R                |                           |
| LMK107BBJ106□ALT  | LMK107 BJ106□ALTD | 6.3               | X5R                         | 10 μ            | ±10, ±20                  | 10        | 150               | 0.8+0.20/-0      | R                         |
| LMK107BBJ226MA-T  |                   |                   | X5R                         | 22 μ            | ±20                       | 10        | 150               | 0.8+0.20/-0      | R                         |
| JMK107 BJ225□A-T  |                   | 6.3               | X5R                         | 2.2 μ           | ±10, ±20                  | 10        | 150               | 0.8±0.10         | R                         |
| JMK107 BJ475□A-T  |                   |                   | X5R                         | 4.7 μ           | ±10, ±20                  | 10        | 150               | 0.8±0.10         | R                         |
| JMK107ABJ106□A-T  | JMK107 BJ106□A-T  | 4                 | X5R                         | 10 μ            | ±10, ±20                  | 10        | 150               | 0.8+0.15/-0.05   | R                         |
| JMK107BBJ226MA-T  |                   |                   | X5R                         | 22 μ            | ±20                       | 10        | 150               | 0.8+0.20/-0      | R                         |
| AMK107 BJ106MA-T  |                   | 4                 | X5R                         | 10 μ            | ±20                       | 10        | 150               | 0.8±0.10         | R                         |
| AMK107BBJ226MA-T  | AMK107 BJ226MA-T  |                   | X5R                         | 22 μ            | ±20                       | 10        | 150               | 0.8+0.20/-0      | R                         |
| AMK107BBJ476MA-RE |                   | X5R               | 47 μ                        | ±20             | 20                        | 150       | 0.8+0.20/-0       | R                |                           |

▶ This catalog contains the typical specification only due to the limitation of space. When you consider the purchase of our products, please check our product specification sheets. For details of each product (characteristics graph, reliability information, precautions for use, and so on), see our website (<http://www.ty-top.com/>).

## 【Temperature Characteristic BJ : X5R(-55~+85°C)】 0.45mm thickness(K)

| Part number 1      | Part number 2     | Rated voltage [V] | Temperature characteristics | Capacitance [F] | Capacitance tolerance [%] | tan δ [%] | HTLT              |     | Thickness <sup>*3</sup> [mm] | Soldering R:Reflow W:Wave |
|--------------------|-------------------|-------------------|-----------------------------|-----------------|---------------------------|-----------|-------------------|-----|------------------------------|---------------------------|
|                    |                   |                   |                             |                 |                           |           | Rated voltage x % |     |                              |                           |
| TMK107 BJ105□K-T   |                   | 25                | X5R                         | 1 μ             | ±10, ±20                  | 10        | 150               |     | 0.45±0.05                    | R                         |
| EMK107 BJ105□K-T   |                   | 16                | X5R                         | 1 μ             | ±10, ±20                  | 10        | 150               |     | 0.45±0.05                    | R                         |
| EMK107BBJ225□K-T   |                   |                   | X5R                         | 2.2 μ           | ±10, ±20                  | 10        | 150               |     | 0.45±0.05                    | R                         |
| LMK107 BJ105□K-T   |                   | 10                | X5R                         | 1 μ             | ±10, ±20                  | 10        | 150               |     | 0.45±0.05                    | R                         |
| LMK107 BJ225□K-T   |                   |                   | X5R                         | 2.2 μ           | ±10, ±20                  | 10        | 150               |     | 0.45±0.05                    | R                         |
| LMK107BBJ475MKLT   | LMK107 BJ475MKLTD |                   | X5R                         | 4.7 μ           | ±20                       | 10        | 150               |     | 0.45±0.05                    | R                         |
| JMK107 BJ105□K-T   |                   |                   | X5R                         | 1 μ             | ±10, ±20                  | 10        | 150               |     | 0.45±0.05                    | R                         |
| JMK107 BJ225□K-T   |                   | 6.3               | X5R                         | 2.2 μ           | ±10, ±20                  | 10        | 150               |     | 0.45±0.05                    | R                         |
| JMK107 BJ475MK-T   |                   |                   | X5R                         | 4.7 μ           | ±20                       | 10        | 150               |     | 0.45±0.05                    | R                         |
| JMK107BBJ106MK-TT  |                   |                   | X5R                         | 10 μ            | ±20                       | 10        | 150               |     | 0.45±0.05                    | R                         |
| AMK107BBJ106MK-T*2 |                   |                   | 4                           | X5R             | 10 μ                      | ±20       | 10                | 150 |                              | 0.45±0.05                 |

## 【Temperature Characteristic C6 : X6S(-55~+105°C)】 0.8mm thickness(A)

| Part number 1    | Part number 2 | Rated voltage [V] | Temperature characteristics | Capacitance [F] | Capacitance tolerance [%] | tan δ [%] | HTLT              |     | Thickness <sup>*3</sup> [mm] | Soldering R:Reflow W:Wave |
|------------------|---------------|-------------------|-----------------------------|-----------------|---------------------------|-----------|-------------------|-----|------------------------------|---------------------------|
|                  |               |                   |                             |                 |                           |           | Rated voltage x % |     |                              |                           |
| TMK107BC6225□A-T |               | 25                | X6S                         | 2.2 μ           | ±10, ±20                  | 10        | 150               |     | 0.8+0.20/-0                  | R                         |
| EMK107 C6105□A-T |               | 16                | X6S                         | 1 μ             | ±10, ±20                  | 5         | 150               |     | 0.8±0.10                     | R                         |
| EMK107BC6225□A-T |               |                   | X6S                         | 2.2 μ           | ±10, ±20                  | 10        | 150               |     | 0.8+0.20/-0                  | R                         |
| EMK107BC6475□A-T |               |                   | X6S                         | 4.7 μ           | ±10, ±20                  | 10        | 150               |     | 0.8+0.20/-0                  | R                         |
| EMK107BC6106MA-T |               |                   | X6S                         | 10 μ            | ±20                       | 10        | 150               |     | 0.8+0.20/-0                  | R                         |
| LMK107 C6105□A-T |               | 10                | X6S                         | 1 μ             | ±10, ±20                  | 5         | 150               |     | 0.8±0.10                     | R                         |
| LMK107AC6475□A-T |               |                   | X6S                         | 4.7 μ           | ±10, ±20                  | 10        | 150               |     | 0.8+0.15/-0.05               | R                         |
| LMK107BC6106MA-T |               |                   | X6S                         | 10 μ            | ±20                       | 10        | 150               |     | 0.8+0.20/-0                  | R                         |
| JMK107 C6105□A-T |               |                   | X6S                         | 1 μ             | ±10, ±20                  | 5         | 150               |     | 0.8±0.10                     | R                         |
| JMK107 C6475□A-T |               | 6.3               | X6S                         | 4.7 μ           | ±10, ±20                  | 10        | 150               |     | 0.8±0.10                     | R                         |
| JMK107BC6106MA-T |               |                   | X6S                         | 10 μ            | ±20                       | 10        | 150               |     | 0.8+0.20/-0                  | R                         |
| JMK107BC6226MA-T |               |                   | X6S                         | 22 μ            | ±20                       | 10        | 150               |     | 0.8+0.20/-0                  | R                         |
| AMK107AC6106MA-T |               |                   | 4                           | X6S             | 10 μ                      | ±20       | 10                | 150 |                              | 0.8+0.15/-0.05            |
| AMK107BC6226MA-T |               |                   | X6S                         | 22 μ            | ±20                       | 10        | 150               |     | 0.8+0.20/-0                  | R                         |

## 【Temperature Characteristic B7 : X7R(-55~+125°C)】 0.8mm thickness(A)

| Part number 1     | Part number 2 | Rated voltage [V] | Temperature characteristics | Capacitance [F] | Capacitance tolerance [%] | tan δ [%] | HTLT              |  | Thickness <sup>*3</sup> [mm] | Soldering R:Reflow W:Wave |
|-------------------|---------------|-------------------|-----------------------------|-----------------|---------------------------|-----------|-------------------|--|------------------------------|---------------------------|
|                   |               |                   |                             |                 |                           |           | Rated voltage x % |  |                              |                           |
| UMK107 B7224□A-TR |               | 50                | X7R                         | 0.22 μ          | ±10, ±20                  | 10        | 150               |  | 0.8±0.10                     | R                         |
| UMK107 B7474□A-TR |               |                   | X7R                         | 0.47 μ          | ±10, ±20                  | 10        | 150               |  | 0.8±0.10                     | R                         |
| UMK107AB7105□A-T  |               |                   | X7R                         | 1 μ             | ±10, ±20                  | 10        | 150               |  | 0.8+0.15/-0.05               | R                         |
| TMK107 B7474□A-TR |               | 25                | X7R                         | 0.47 μ          | ±10, ±20                  | 10        | 150               |  | 0.8±0.10                     | R                         |
| TMK107 B7105□A-T  |               |                   | X7R                         | 1 μ             | ±10, ±20                  | 10        | 150               |  | 0.8±0.10                     | R                         |
| EMK107 B7224□A-T  |               |                   | X7R                         | 0.22 μ          | ±10, ±20                  | 3.5       | 150               |  | 0.8±0.10                     | R/W                       |
| EMK107 B7474□A-T  |               |                   | X7R                         | 0.47 μ          | ±10, ±20                  | 3.5       | 150               |  | 0.8±0.10                     | R                         |
| EMK107 B7105□A-T  |               | 16                | X7R                         | 1 μ             | ±10, ±20                  | 5         | 150               |  | 0.8±0.10                     | R                         |
| EMK107BB7225□A-T  |               |                   | X7R                         | 2.2 μ           | ±10, ±20                  | 10        | 150               |  | 0.8+0.20/-0                  | R                         |
| LMK107 B7224□A-T  |               |                   | X7R                         | 0.22 μ          | ±10, ±20                  | 3.5       | 200               |  | 0.8±0.10                     | R/W                       |
| LMK107 B7474□A-T  |               |                   | X7R                         | 0.47 μ          | ±10, ±20                  | 3.5       | 200               |  | 0.8±0.10                     | R                         |
| LMK107 B7105□A-T  |               | 10                | X7R                         | 1 μ             | ±10, ±20                  | 5         | 150               |  | 0.8±0.10                     | R                         |
| LMK107 B7225□A-TR |               |                   | X7R                         | 2.2 μ           | ±10, ±20                  | 10        | 150               |  | 0.8±0.10                     | R                         |
| JMK107 B7224□A-T  |               |                   | X7R                         | 0.22 μ          | ±10, ±20                  | 3.5       | 200               |  | 0.8±0.10                     | R/W                       |
| JMK107 B7474□A-T  |               |                   | X7R                         | 0.47 μ          | ±10, ±20                  | 3.5       | 200               |  | 0.8±0.10                     | R                         |
| JMK107 B7105□A-T  |               | 6.3               | X7R                         | 1 μ             | ±10, ±20                  | 5         | 150               |  | 0.8±0.10                     | R                         |
| JMK107 B7225□A-TR |               |                   | X7R                         | 2.2 μ           | ±10, ±20                  | 10        | 200               |  | 0.8±0.10                     | R                         |
| JMK107BB7475□A-T  |               |                   | X7R                         | 4.7 μ           | ±10, ±20                  | 10        | 150               |  | 0.8+0.20/-0                  | R                         |

## ● 212TYPE

## 【Temperature Characteristic BJ : B(-25~+85°C)/X5R(-55~+85°C)】 1.25mm thickness(G)

| Part number 1     | Part number 2    | Rated voltage [V] | Temperature characteristics | Capacitance [F] | Capacitance tolerance [%] | tan δ [%] | HTLT              |  | Thickness <sup>*3</sup> [mm] | Soldering R:Reflow W:Wave |
|-------------------|------------------|-------------------|-----------------------------|-----------------|---------------------------|-----------|-------------------|--|------------------------------|---------------------------|
|                   |                  |                   |                             |                 |                           |           | Rated voltage x % |  |                              |                           |
| UMK212 BJ104□G-T  |                  | 50                | B X5R <sup>*1</sup>         | 0.1 μ           | ±10, ±20                  | 3.5       | 200               |  | 1.25±0.10                    | R/W                       |
| UMK212 BJ224□G-T  |                  |                   | B X5R <sup>*1</sup>         | 0.22 μ          | ±10, ±20                  | 3.5       | 200               |  | 1.25±0.10                    | R/W                       |
| UMK212 BJ474□G-T  |                  |                   | B X5R <sup>*1</sup>         | 0.47 μ          | ±10, ±20                  | 3.5       | 150               |  | 1.25±0.10                    | R/W                       |
| UMK212 BJ105□G-T  |                  |                   | B X5R                       | 1 μ             | ±10, ±20                  | 5         | 150               |  | 1.25±0.10                    | R/W                       |
| UMK212ABJ225□G-T  |                  |                   | B X5R                       | 2.2 μ           | ±10, ±20                  | 10        | 150               |  | 1.25+0.15/-0.05              | R                         |
| UMK212BBJ475□G-T  |                  | 35                | X5R                         | 4.7 μ           | ±10, ±20                  | 10        | 150               |  | 1.25+0.20/-0                 | R                         |
| GMK212BBJ106□G-T  |                  |                   | X5R                         | 10 μ            | ±10, ±20                  | 10        | 150               |  | 1.25+0.20/-0                 | R                         |
| TMK212 BJ225□G-T  |                  |                   | B X5R                       | 2.2 μ           | ±10, ±20                  | 5         | 150               |  | 1.25±0.10                    | R                         |
| TMK212ABJ475□G-T  | TMK212 BJ475□G-T | 25                | X5R                         | 4.7 μ           | ±10, ±20                  | 10        | 150               |  | 1.25+0.15/-0.05              | R                         |
| TMK212BBJ106MG-T  |                  |                   | X5R                         | 10 μ            | ±20                       | 10        | 150               |  | 1.25+0.20/-0                 | R                         |
| TMK212BBJ226MG-TT |                  |                   | X5R                         | 22 μ            | ±20                       | 10        | 150               |  | 1.25+0.20/-0                 | R                         |
| EMK212 BJ225□G-T  |                  |                   | X5R <sup>*1</sup>           | 2.2 μ           | ±10, ±20                  | 5         | 200               |  | 1.25±0.10                    | R                         |
| EMK212ABJ475□G-T  | EMK212 BJ475□G-T | 16                | X5R <sup>*1</sup>           | 4.7 μ           | ±10, ±20                  | 5         | 150               |  | 1.25+0.15/-0.05              | R                         |
| EMK212ABJ106□G-T  | EMK212 BJ106□G-T |                   | X5R                         | 10 μ            | ±10, ±20                  | 10        | 150               |  | 1.25+0.15/-0.05              | R                         |
| EMK212BBJ226MG-T  |                  |                   | X5R                         | 22 μ            | ±20                       | 10        | 150               |  | 1.25+0.20/-0                 | R                         |
| LMK212 BJ225□G-T  |                  |                   | X5R <sup>*1</sup>           | 2.2 μ           | ±10, ±20                  | 5         | 200               |  | 1.25±0.10                    | R                         |
| LMK212ABJ475□G-T  | LMK212 BJ475□G-T | 10                | X5R <sup>*1</sup>           | 4.7 μ           | ±10, ±20                  | 5         | 200               |  | 1.25+0.15/-0.05              | R                         |
| LMK212ABJ106□G-T  | LMK212 BJ106□G-T |                   | X5R                         | 10 μ            | ±10, ±20                  | 10        | 200               |  | 1.25+0.15/-0.05              | R                         |
| LMK212BBJ226MG-T  | LMK212 BJ226MG-T |                   | X5R                         | 22 μ            | ±20                       | 10        | 150               |  | 1.25+0.20/-0                 | R                         |
| LMK212BBJ476MG-T  |                  |                   | X5R                         | 47 μ            | ±20                       | 10        | 150               |  | 1.25+0.20/-0                 | R                         |
| JMK212ABJ475□G-T  | JMK212 BJ475□G-T | 6.3               | X5R                         | 4.7 μ           | ±10, ±20                  | 5         | 200               |  | 1.25+0.15/-0.05              | R                         |
| JMK212ABJ106□G-T  | JMK212 BJ106□G-T |                   | X5R <sup>*1</sup>           | 10 μ            | ±10, ±20                  | 10        | 200               |  | 1.25+0.15/-0.05              | R                         |
| JMK212ABJ226MG-T  | JMK212 BJ226MG-T |                   | X5R                         | 22 μ            | ±20                       | 10        | 150               |  | 1.25+0.15/-0.05              | R                         |
| JMK212BBJ476MG-T  | JMK212 BJ476MG-T |                   | X5R                         | 47 μ            | ±20                       | 10        | 150               |  | 1.25+0.20/-0                 | R                         |
| PMK212BBJ107MG-T  |                  | 2.5               | X5R                         | 100 μ           | ±20                       | 10        | 150               |  | 1.25+0.20/-0                 | R                         |

▶ This catalog contains the typical specification only due to the limitation of space. When you consider the purchase of our products, please check our product specification sheets. For details of each product (characteristics graph, reliability information, precautions for use, and so on), see our website (<http://www.ty-top.com/>).

## 【Temperature Characteristic BJ : B(-25~+85°C)/X5R(-55~+85°C)】 0.85mm thickness (D)

| Part number 1    | Part number 2     | Rated voltage [V] | Temperature characteristics | Capacitance [F] | Capacitance tolerance [%] | tan δ [%] | HTLT              | Thickness*3 [mm] | Soldering R:Reflow W:Wave |
|------------------|-------------------|-------------------|-----------------------------|-----------------|---------------------------|-----------|-------------------|------------------|---------------------------|
|                  |                   |                   |                             |                 |                           |           | Rated voltage x % |                  |                           |
| UMK212ABJ105□D-T | UMK212 BJ105□D-TD | 50                | X5R                         | 1 μ             | ±10, ±20                  | 10        | 150               | 0.85±0.10        | R                         |
| UMK212BBJ225□D-T |                   |                   | X5R                         | 2.2 μ           | ±10, ±20                  | 10        | 150               | 0.85±0.10        | R                         |
| GMK212BBJ475□D-T |                   | 35                | X5R                         | 4.7 μ           | ±10, ±20                  | 10        | 150               | 0.85±0.10        | R                         |
| TMK212 BJ474□D-T |                   |                   | B X5R                       | 0.47 μ          | ±10, ±20                  | 3.5       | 200               | 0.85±0.10        | R                         |
| TMK212 BJ105□D-T |                   | 25                | B X5R                       | 1 μ             | ±10, ±20                  | 5         | 200               | 0.85±0.10        | R                         |
| TMK212ABJ225□D-T | TMK212 BJ225□D-T  |                   | X5R                         | 2.2 μ           | ±10, ±20                  | 5         | 150               | 0.85±0.10        | R                         |
| TMK212BBJ475□D-T | TMK212 BJ475□D-TD |                   | X5R                         | 4.7 μ           | ±10, ±20                  | 10        | 150               | 0.85±0.10        | R                         |
| TMK212BBJ106□D-T |                   |                   | X5R                         | 10 μ            | ±10, ±20                  | 10        | 150               | 0.85±0.10        | R                         |
| EMK212 BJ105□D-T |                   |                   | B X5R*1                     | 1 μ             | ±10, ±20                  | 5         | 200               | 0.85±0.10        | R                         |
| EMK212ABJ225□D-T | EMK212 BJ225□D-T  |                   | X5R*1                       | 2.2 μ           | ±10, ±20                  | 5         | 200               | 0.85±0.10        | R                         |
| EMK212 BJ475□D-T |                   | 16                | X5R                         | 4.7 μ           | ±10, ±20                  | 10        | 150               | 0.85±0.10        | R                         |
| EMK212ABJ106□D-T | EMK212 BJ106□D-TD |                   | X5R                         | 10 μ            | ±10, ±20                  | 10        | 150               | 0.85±0.10        | R                         |
| LMK212 BJ105□D-T |                   |                   | B X5R*1                     | 1 μ             | ±10, ±20                  | 3.5       | 200               | 0.85±0.10        | R                         |
| LMK212 BJ225□D-T |                   |                   | X5R*1                       | 2.2 μ           | ±10, ±20                  | 5         | 200               | 0.85±0.10        | R                         |
| LMK212ABJ106□D-T | LMK212 BJ106□D-T  |                   | X5R                         | 10 μ            | ±10, ±20                  | 10        | 150               | 0.85±0.10        | R                         |
| LMK212BBJ226MD-T |                   |                   | X5R                         | 22 μ            | ±20                       | 10        | 150               | 0.85±0.10        | R                         |
| JMK212ABJ106□D-T | JMK212 BJ106□D-T  | 6.3               | X5R                         | 10 μ            | ±10, ±20                  | 10        | 200               | 0.85±0.10        | R                         |
| JMK212ABJ226MD-T | JMK212 BJ226MD-T  |                   | X5R                         | 22 μ            | ±20                       | 10        | 150               | 0.85±0.10        | R                         |
| AMK212BBJ476MD-T |                   |                   | X5R                         | 47 μ            | ±20                       | 10        | 150               | 0.85±0.10        | R                         |

## 【Temperature Characteristic BJ : X5R(-55~+85°C)】 0.45mm thickness (K)

| Part number 1       | Part number 2    | Rated voltage [V] | Temperature characteristics | Capacitance [F] | Capacitance tolerance [%] | tan δ [%] | HTLT              | Thickness*3 [mm] | Soldering R:Reflow W:Wave |
|---------------------|------------------|-------------------|-----------------------------|-----------------|---------------------------|-----------|-------------------|------------------|---------------------------|
|                     |                  |                   |                             |                 |                           |           | Rated voltage x % |                  |                           |
| TMK212BBJ225□K-T    |                  | 25                | X5R                         | 2.2 μ           | ±10, ±20                  | 10        | 150               | 0.45±0.05        | R                         |
| EMK212BBJ475□K-T    |                  | 16                | X5R                         | 4.7 μ           | ±10, ±20                  | 10        | 150               | 0.45±0.05        | R                         |
| LMK212ABJ475□K-T    | LMK212 BJ475□K-T | 10                | X5R                         | 4.7 μ           | ±10, ±20                  | 10        | 150               | 0.45±0.05        | R                         |
| JMK212ABJ475□K-T    | JMK212 BJ475□K-T | 6.3               | X5R                         | 4.7 μ           | ±10, ±20                  | 10        | 150               | 0.45±0.05        | R                         |
| JMK212ABJ106MK-T *2 | JMK212 BJ106MK-T |                   | X5R                         | 10 μ            | ±20                       | 10        | 150               | 0.45±0.05        | R                         |

## 【Temperature Characteristic C6 : X6S(-55~+105°C)】 1.25mm thickness (G)

| Part number 1     | Part number 2 | Rated voltage [V] | Temperature characteristics | Capacitance [F] | Capacitance tolerance [%] | tan δ [%] | HTLT              | Thickness*3 [mm] | Soldering R:Reflow W:Wave |
|-------------------|---------------|-------------------|-----------------------------|-----------------|---------------------------|-----------|-------------------|------------------|---------------------------|
|                   |               |                   |                             |                 |                           |           | Rated voltage x % |                  |                           |
| EMK212BC6226MG-TT |               | 16                | X6S                         | 22 μ            | ±20                       | 10        | 150               | 1.25+0.20/-0     | R                         |
| LMK212BC6226MG-T  |               | 10                | X6S                         | 22 μ            | ±20                       | 10        | 150               | 1.25+0.20/-0     | R                         |
| JMK212BC6226MG-T  |               | 6.3               | X6S                         | 22 μ            | ±20                       | 10        | 150               | 1.25+0.20/-0     | R                         |
| JMK212BC6476MG-T  |               |                   | X6S                         | 47 μ            | ±20                       | 10        | 150               | 1.25+0.20/-0     | R                         |
| AMK212AC6226MG-T  |               |                   | X6S                         | 22 μ            | ±20                       | 10        | 150               | 1.25+0.15/-0.05  | R                         |
| AMK212BC6476MG-T  |               | 4                 | X6S                         | 47 μ            | ±20                       | 10        | 150               | 1.25+0.20/-0     | R                         |

## 【Temperature Characteristic C6 : X6S(-55~+105°C)】 0.85mm thickness (D)

| Part number 1    | Part number 2 | Rated voltage [V] | Temperature characteristics | Capacitance [F] | Capacitance tolerance [%] | tan δ [%] | HTLT              | Thickness*3 [mm] | Soldering R:Reflow W:Wave |
|------------------|---------------|-------------------|-----------------------------|-----------------|---------------------------|-----------|-------------------|------------------|---------------------------|
|                  |               |                   |                             |                 |                           |           | Rated voltage x % |                  |                           |
| LMK212AC6106□D-T |               | 10                | X6S                         | 10 μ            | ±10, ±20                  | 10        | 150               | 0.85±0.10        | R                         |
| AMK212BC6226MD-T |               | 4                 | X6S                         | 22 μ            | ±20                       | 10        | 150               | 0.85±0.10        | R                         |

## 【Temperature Characteristic B7 : X7R(-55~+125°C)】 1.25mm thickness (G)

| Part number 1     | Part number 2     | Rated voltage [V] | Temperature characteristics | Capacitance [F] | Capacitance tolerance [%] | tan δ [%] | HTLT              | Thickness*3 [mm] | Soldering R:Reflow W:Wave |
|-------------------|-------------------|-------------------|-----------------------------|-----------------|---------------------------|-----------|-------------------|------------------|---------------------------|
|                   |                   |                   |                             |                 |                           |           | Rated voltage x % |                  |                           |
| UMK212 B7104□G-T  |                   | 50                | X7R                         | 0.1 μ           | ±10, ±20                  | 3.5       | 200               | 1.25±0.10        | R/W                       |
| UMK212 B7224□G-T  |                   |                   | X7R                         | 0.22 μ          | ±10, ±20                  | 3.5       | 150               | 1.25±0.10        | R/W                       |
| UMK212 B7474□G-T  |                   |                   | X7R                         | 0.47 μ          | ±10, ±20                  | 3.5       | 150               | 1.25±0.10        | R/W                       |
| UMK212 B7105□G-T  |                   |                   | X7R                         | 1 μ             | ±10, ±20                  | 10        | 150               | 1.25±0.10        | R/W                       |
| UMK212BB7225□G-T  |                   |                   | X7R                         | 2.2 μ           | ±10, ±20                  | 10        | 150               | 1.25+0.20/-0     | R                         |
| GMK212 B7105□G-T  |                   |                   | 35                          | X7R             | 1 μ                       | ±10, ±20  | 3.5               | 150              | 1.25±0.10                 |
| TMK212 B7105□G-T  |                   | 25                | X7R                         | 1 μ             | ±10, ±20                  | 3.5       | 150               | 1.25±0.10        | R/W                       |
| TMK212 B7225□G-TR |                   |                   | X7R                         | 2.2 μ           | ±10, ±20                  | 10        | 150               | 1.25±0.10        | R                         |
| TMK212AB7475□G-T  | TMK212 B7475□G-T  |                   | X7R                         | 4.7 μ           | ±10, ±20                  | 10        | 150               | 1.25+0.15/-0.05  | R                         |
| EMK212 B7105□G-T  |                   | 16                | X7R                         | 1 μ             | ±10, ±20                  | 3.5       | 200               | 1.25±0.10        | R/W                       |
| EMK212 B7225□G-T  |                   |                   | X7R                         | 2.2 μ           | ±10, ±20                  | 10        | 150               | 1.25±0.10        | R                         |
| EMK212 B7475□G-T  |                   |                   | X7R                         | 4.7 μ           | ±10, ±20                  | 10        | 150               | 1.25±0.10        | R                         |
| EMK212BB7106MG-T  |                   |                   | X7R                         | 10 μ            | ±20                       | 10        | 150               | 1.25+0.20/-0     | R                         |
| LMK212 B7105□G-T  |                   | 10                | X7R                         | 1 μ             | ±10, ±20                  | 3.5       | 200               | 1.25±0.10        | R/W                       |
| LMK212 B7225□G-T  |                   |                   | X7R                         | 2.2 μ           | ±10, ±20                  | 5         | 200               | 1.25±0.10        | R                         |
| LMK212 B7475□G-T  |                   |                   | X7R                         | 4.7 μ           | ±10, ±20                  | 10        | 150               | 1.25±0.10        | R                         |
| LMK212AB7106□G-T  | LMK212 B7106□G-TD |                   | X7R                         | 10 μ            | ±10, ±20                  | 10        | 150               | 1.25+0.15/-0.05  | R                         |
| JMK212AB7106□G-T  | JMK212 B7106□G-T  | 6.3               | X7R                         | 10 μ            | ±10, ±20                  | 10        | 150               | 1.25+0.15/-0.05  | R                         |

## 【Temperature Characteristic B7 : X7R(-55~+125°C)】 0.85mm thickness(D)

| Part number 1     | Part number 2     | Rated voltage [V] | Temperature characteristics |     | Capacitance [F] | Capacitance tolerance [%] | tan δ [%] | HTLT              | Thickness <sup>*3</sup> [mm] | Soldering R:Reflow W:Wave |   |
|-------------------|-------------------|-------------------|-----------------------------|-----|-----------------|---------------------------|-----------|-------------------|------------------------------|---------------------------|---|
|                   |                   |                   |                             |     |                 |                           |           | Rated voltage x % |                              |                           |   |
| UMK212AB7104□D-T  |                   | 50                |                             | X7R | 0.1 μ           | ±10, ±20                  | 10        | 150               | 0.85±0.10                    | R                         |   |
| UMK212AB7224□D-T  |                   |                   |                             | X7R | 0.22 μ          | ±10, ±20                  | 10        | 150               | 0.85±0.10                    | R                         |   |
| UMK212AB7474□D-T  |                   |                   |                             | X7R | 0.47 μ          | ±10, ±20                  | 10        | 150               | 0.85±0.10                    | R                         |   |
| UMK212AB7105□D-T  |                   |                   |                             | X7R | 1 μ             | ±10, ±20                  | 10        | 150               | 0.85±0.10                    | R                         |   |
| TMK212AB7225□D-TR |                   | 25                |                             | X7R | 2.2 μ           | ±10, ±20                  | 10        | 150               | 0.85±0.10                    | R                         |   |
| EMK212 B7474□D-T  |                   | 16                |                             | X7R | 0.47 μ          | ±10, ±20                  | 3.5       | 200               | 0.85±0.10                    | R/W                       |   |
| EMK212 B7105□D-T  |                   |                   |                             | X7R | 1 μ             | ±10, ±20                  | 5         | 200               | 0.85±0.10                    | R                         |   |
| EMK212AB7225□D-T  | EMK212 B7225□D-T  |                   |                             |     | X7R             | 2.2 μ                     | ±10, ±20  | 5                 | 150                          | 0.85±0.10                 | R |
| EMK212BB7475□D-T  |                   |                   |                             |     | X7R             | 4.7 μ                     | ±10, ±20  | 10                | 150                          | 0.85±0.10                 | R |
| LMK212 B7105□D-T  |                   | 10                |                             | X7R | 1 μ             | ±10, ±20                  | 3.5       | 200               | 0.85±0.10                    | R                         |   |
| LMK212AB7225□D-T  | LMK212 B7225□D-T  |                   |                             |     | X7R             | 2.2 μ                     | ±10, ±20  | 5                 | 200                          | 0.85±0.10                 | R |
| LMK212AB7475□D-TR | LMK212 B7475□D-TR |                   |                             |     | X7R             | 4.7 μ                     | ±10, ±20  | 10                | 150                          | 0.85±0.10                 | R |

## ● 316TYPE

## 【Temperature Characteristic BJ : B(-25~+85°C)/X5R(-55~+85°C)】 1.6mm thickness(L)

| Part number 1    | Part number 2    | Rated voltage [V] | Temperature characteristics |                   | Capacitance [F]   | Capacitance tolerance [%] | tan δ [%] | HTLT              | Thickness <sup>*3</sup> [mm] | Soldering R:Reflow W:Wave |   |
|------------------|------------------|-------------------|-----------------------------|-------------------|-------------------|---------------------------|-----------|-------------------|------------------------------|---------------------------|---|
|                  |                  |                   |                             |                   |                   |                           |           | Rated voltage x % |                              |                           |   |
| UMK316 BJ105□L-T |                  | 50                | B                           | X5R <sup>*1</sup> | 1 μ               | ±10, ±20                  | 3.5       | 200               | 1.6±0.20                     | R                         |   |
| UMK316 BJ225□L-T |                  |                   |                             |                   | X5R               | 2.2 μ                     | ±10, ±20  | 10                | 150                          | 1.6±0.20                  | R |
| UMK316 BJ475□L-T |                  |                   |                             |                   | X5R               | 4.7 μ                     | ±10, ±20  | 10                | 150                          | 1.6±0.20                  | R |
| UMK316BBJ106□L-T |                  |                   |                             |                   | X5R               | 10 μ                      | ±10, ±20  | 10                | 150                          | 1.6±0.30                  | R |
| TMK316 BJ225□L-T |                  | 25                | B                           | X5R <sup>*1</sup> | 2.2 μ             | ±10, ±20                  | 3.5       | 200               | 1.6±0.20                     | R                         |   |
| TMK316 BJ475□L-T |                  |                   |                             | B                 | X5R               | 4.7 μ                     | ±10, ±20  | 5                 | 150                          | 1.6±0.20                  | R |
| TMK316 BJ106□L-T |                  |                   |                             |                   | X5R <sup>*1</sup> | 10 μ                      | ±10, ±20  | 5                 | 150                          | 1.6±0.20                  | R |
| TMK316BBJ226ML-T |                  |                   |                             |                   | X5R               | 22 μ                      | ±20       | 10                | 150                          | 1.6±0.30                  | R |
| EMK316 BJ225□L-T |                  | 16                | B                           | X5R <sup>*1</sup> | 2.2 μ             | ±10, ±20                  | 3.5       | 200               | 1.6±0.20                     | R/W                       |   |
| EMK316 BJ475□L-T |                  |                   |                             | B                 | X5R               | 4.7 μ                     | ±10, ±20  | 5                 | 200                          | 1.6±0.20                  | R |
| EMK316 BJ106□L-T |                  |                   |                             |                   | X5R <sup>*1</sup> | 10 μ                      | ±10, ±20  | 5                 | 150                          | 1.6±0.20                  | R |
| EMK316ABJ226□L-T | EMK316 BJ226□L-T |                   |                             |                   | X5R               | 22 μ                      | ±10, ±20  | 10                | 150                          | 1.6±0.20                  | R |
| LMK316 BJ106□L-T |                  | 10                |                             | X5R <sup>*1</sup> | 10 μ              | ±10, ±20                  | 5         | 200               | 1.6±0.20                     | R                         |   |
| LMK316ABJ226□L-T | LMK316 BJ226□L-T |                   |                             |                   | X5R               | 22 μ                      | ±10, ±20  | 10                | 150                          | 1.6±0.20                  | R |
| LMK316ABJ476ML-T | LMK316 BJ476ML-T |                   |                             |                   | X5R               | 47 μ                      | ±20       | 10                | 150                          | 1.6±0.20                  | R |
| LMK316BBJ107ML-T |                  |                   |                             |                   | X5R               | 100 μ                     | ±20       | 10                | 150                          | 1.6±0.30                  | R |
| JMK316 BJ106□L-T |                  | 6.3               |                             | X5R <sup>*1</sup> | 10 μ              | ±10, ±20                  | 5         | 200               | 1.6±0.20                     | R                         |   |
| JMK316ABJ226□L-T | JMK316 BJ226□L-T |                   |                             |                   | X5R               | 22 μ                      | ±10, ±20  | 10                | 200                          | 1.6±0.20                  | R |
| JMK316ABJ476ML-T | JMK316 BJ476ML-T |                   |                             |                   | X5R               | 47 μ                      | ±20       | 10                | 200                          | 1.6±0.20                  | R |
| JMK316ABJ107ML-T | JMK316 BJ107ML-T |                   |                             |                   | X5R               | 100 μ                     | ±20       | 10                | 150                          | 1.6±0.20                  | R |
| AMK316ABJ107ML-T | AMK316 BJ107ML-T | 4                 |                             | X5R               | 100 μ             | ±20                       | 10        | 150               | 1.6±0.20                     | R                         |   |
| AMK316BBJ157ML-T |                  |                   |                             |                   | X5R               | 150 μ                     | ±20       | 10                | 150                          | 1.6±0.30                  | R |
| PMK316BBJ227ML-T |                  | 2.5               |                             | X5R               | 220 μ             | ±20                       | 10        | 150               | 1.6±0.30                     | R                         |   |

## 【Temperature Characteristic BJ : B(-25~+85°C)/X5R(-55~+85°C)】 0.85mm thickness(D)

| Part number 1    | Part number 2     | Rated voltage [V] | Temperature characteristics |     | Capacitance [F] | Capacitance tolerance [%] | tan δ [%] | HTLT              | Thickness <sup>*3</sup> [mm] | Soldering R:Reflow W:Wave |   |
|------------------|-------------------|-------------------|-----------------------------|-----|-----------------|---------------------------|-----------|-------------------|------------------------------|---------------------------|---|
|                  |                   |                   |                             |     |                 |                           |           | Rated voltage x % |                              |                           |   |
| UMK316 BJ105□D-T |                   | 50                | B                           | X5R | 1 μ             | ±10, ±20                  | 3.5       | 150               | 0.85±0.10                    | R                         |   |
| UMK316 BJ225□D-T |                   |                   |                             | B   | X5R             | 2.2 μ                     | ±10, ±20  | 3.5               | 150                          | 0.85±0.10                 | R |
| UMK316ABJ475□D-T | UMK316 BJ475□D-T  |                   |                             |     | X5R             | 4.7 μ                     | ±10, ±20  | 10                | 150                          | 0.85±0.10                 | R |
| TMK316 BJ105□D-T |                   |                   |                             | B   | X5R             | 1 μ                       | ±10, ±20  | 3.5               | 200                          | 0.85±0.10                 | R |
| TMK316 BJ225□D-T |                   | 25                | B                           | X5R | 2.2 μ           | ±10, ±20                  | 3.5       | 150               | 0.85±0.10                    | R                         |   |
| TMK316 BJ475□D-T |                   |                   |                             |     | X5R             | 4.7 μ                     | ±10, ±20  | 5                 | 150                          | 0.85±0.10                 | R |
| TMK316ABJ106□D-T | TMK316 BJ106□D-TD |                   |                             |     | X5R             | 10 μ                      | ±10, ±20  | 10                | 150                          | 0.85±0.10                 | R |
| EMK316 BJ225□D-T |                   |                   |                             | B   | X5R             | 2.2 μ                     | ±10, ±20  | 3.5               | 200                          | 0.85±0.10                 | R |
| EMK316 BJ475□D-T |                   | 16                | B                           | X5R | 4.7 μ           | ±10, ±20                  | 5         | 200               | 0.85±0.10                    | R                         |   |
| EMK316 BJ106□D-T |                   |                   |                             |     | X5R             | 10 μ                      | ±10, ±20  | 10                | 150                          | 0.85±0.10                 | R |
| EMK316ABJ226MD-T | EMK316 BJ226MD-T  |                   |                             |     | X5R             | 22 μ                      | ±20       | 10                | 150                          | 0.85±0.10                 | R |
| LMK316 BJ475□D-T |                   |                   |                             | B   | X5R             | 4.7 μ                     | ±10, ±20  | 5                 | 200                          | 0.85±0.10                 | R |
| LMK316 BJ106□D-T |                   | 10                |                             | X5R | 10 μ            | ±10, ±20                  | 10        | 200               | 0.85±0.10                    | R                         |   |
| LMK316ABJ226MD-T | LMK316 BJ226MD-T  |                   |                             |     | X5R             | 22 μ                      | ±20       | 10                | 150                          | 0.85±0.10                 | R |
| JMK316 BJ106□D-T |                   |                   |                             |     | X5R             | 10 μ                      | ±10, ±20  | 10                | 200                          | 0.85±0.10                 | R |
| JMK316ABJ226MD-T | JMK316 BJ226MD-T  |                   |                             |     | X5R             | 22 μ                      | ±20       | 10                | 150                          | 0.85±0.10                 | R |
| JMK316ABJ476MD-T | JMK316 BJ476MD-T  | 6.3               |                             | X5R | 47 μ            | ±20                       | 10        | 150               | 0.85±0.10                    | R                         |   |

## 【Temperature Characteristic C6 : X6S(-55~+105°C)】 1.6mm thickness(L)

| Part number 1    | Part number 2 | Rated voltage [V] | Temperature characteristics |     | Capacitance [F] | Capacitance tolerance [%] | tan δ [%] | HTLT              | Thickness <sup>*3</sup> [mm] | Soldering R:Reflow W:Wave |   |
|------------------|---------------|-------------------|-----------------------------|-----|-----------------|---------------------------|-----------|-------------------|------------------------------|---------------------------|---|
|                  |               |                   |                             |     |                 |                           |           | Rated voltage x % |                              |                           |   |
| EMK316BC6226ML-T |               | 16                |                             | X6S | 22 μ            | ±20                       | 10        | 150               | 1.6±0.30                     | R                         |   |
| LMK316BC6476ML-T |               | 10                |                             | X6S | 47 μ            | ±20                       | 10        | 150               | 1.6±0.30                     | R                         |   |
| JMK316AC6476ML-T |               | 6.3               |                             | X6S | 47 μ            | ±20                       | 10        | 150               | 1.6±0.20                     | R                         |   |
| JMK316BC6107ML-T |               |                   |                             |     | X6S             | 100 μ                     | ±20       | 10                | 150                          | 1.6±0.30                  | R |
| AMK316AC6476ML-T |               |                   | 4                           |     | X6S             | 47 μ                      | ±20       | 10                | 200                          | 1.6±0.20                  | R |
| AMK316AC6107ML-T |               |                   |                             |     | X6S             | 100 μ                     | ±20       | 10                | 150                          | 1.6±0.20                  | R |

## 【Temperature Characteristic C7 : X7S(-55~+125°C)】 1.6mm thickness(L)

| Part number 1    | Part number 2 | Rated voltage [V] | Temperature characteristics |     | Capacitance [F] | Capacitance tolerance [%] | tan δ [%] | HTLT              | Thickness <sup>*3</sup> [mm] | Soldering R:Reflow W:Wave |
|------------------|---------------|-------------------|-----------------------------|-----|-----------------|---------------------------|-----------|-------------------|------------------------------|---------------------------|
|                  |               |                   |                             |     |                 |                           |           | Rated voltage x % |                              |                           |
| AMK316AC7476ML-T |               | 4                 |                             | X7S | 47 μ            | ±20                       | 10        | 150               | 1.6±0.20                     | R                         |

▶ This catalog contains the typical specification only due to the limitation of space. When you consider the purchase of our products, please check our product specification sheets. For details of each product (characteristics graph, reliability information, precautions for use, and so on), see our website (<http://www.ty-top.com/>).

## 【Temperature Characteristic B7 : X7R(-55~+125°C)】 1.6mm thickness (L)

| Part number 1     | Part number 2     | Rated voltage [V] | Temperature characteristics | Capacitance [F] | Capacitance tolerance [%] | tan δ [%] | HTLT              | Thickness*3 [mm] | Soldering R:Reflow W:Wave |
|-------------------|-------------------|-------------------|-----------------------------|-----------------|---------------------------|-----------|-------------------|------------------|---------------------------|
|                   |                   |                   |                             |                 |                           |           | Rated voltage x % |                  |                           |
| UMK316 B7224□L-T  |                   | 50                | X7R                         | 0.22 μ          | ±10, ±20                  | 2.5       | 200               | 1.6±0.20         | R/W                       |
| UMK316 B7474□L-T  |                   |                   | X7R                         | 0.47 μ          | ±10, ±20                  | 3.5       | 200               | 1.6±0.20         | R/W                       |
| UMK316 B7105□L-T  |                   |                   | X7R                         | 1 μ             | ±10, ±20                  | 3.5       | 200               | 1.6±0.20         | R                         |
| UMK316 B7225□L-T  |                   |                   | X7R                         | 2.2 μ           | ±10, ±20                  | 10        | 150               | 1.6±0.20         | R                         |
| UMK316AB7475□L-T  | UMK316 B7475□L-T  |                   | X7R                         | 4.7 μ           | ±10, ±20                  | 10        | 150               | 1.6±0.20         | R                         |
| GMK316AB7106□L-TR |                   | 35                | X7R                         | 10 μ            | ±10, ±20                  | 10        | 150               | 1.6±0.20         | R                         |
| TMK316 B7105□L-T  |                   |                   | X7R                         | 1 μ             | ±10, ±20                  | 3.5       | 200               | 1.6±0.20         | R/W                       |
| TMK316 B7225□L-T  |                   | 25                | X7R                         | 2.2 μ           | ±10, ±20                  | 3.5       | 200               | 1.6±0.20         | R                         |
| TMK316AB7475□L-T  | TMK316 B7475□L-T  |                   | X7R                         | 4.7 μ           | ±10, ±20                  | 10        | 200               | 1.6±0.20         | R                         |
| TMK316AB7106□L-T  | TMK316 B7106□L-TD |                   | X7R                         | 10 μ            | ±10, ±20                  | 10        | 150               | 1.6±0.20         | R                         |
| EMK316 B7225□L-T  |                   | 16                | X7R                         | 2.2 μ           | ±10, ±20                  | 3.5       | 200               | 1.6±0.20         | R/W                       |
| EMK316 B7475□L-T  |                   |                   | X7R                         | 4.7 μ           | ±10, ±20                  | 5         | 200               | 1.6±0.20         | R                         |
| EMK316AB7106□L-T  | EMK316 B7106□L-TD |                   | X7R                         | 10 μ            | ±10, ±20                  | 10        | 200               | 1.6±0.20         | R                         |
| EMK316BB7226ML-T  |                   |                   | X7R                         | 22 μ            | ±20                       | 10        | 150               | 1.6±0.30         | R                         |
| LMK316 B7225□L-T  |                   | 10                | X7R                         | 2.2 μ           | ±10, ±20                  | 3.5       | 200               | 1.6±0.20         | R/W                       |
| LMK316 B7475□L-T  |                   |                   | X7R                         | 4.7 μ           | ±10, ±20                  | 5         | 200               | 1.6±0.20         | R                         |
| LMK316AB7106□L-T  | LMK316 B7106□L-TD |                   | X7R                         | 10 μ            | ±10, ±20                  | 10        | 200               | 1.6±0.20         | R                         |
| LMK316AB7226□L-TR | LMK316 B7226□L-TD |                   | X7R                         | 22 μ            | ±10, ±20                  | 10        | 150               | 1.6±0.20         | R                         |
| JMK316 B7106□L-T  |                   | 6.3               | X7R                         | 10 μ            | ±10, ±20                  | 5         | 200               | 1.6±0.20         | R                         |

## 【Temperature Characteristic B7 : X7R(-55~+125°C)】 0.85mm thickness (D)

| Part number 1    | Part number 2 | Rated voltage [V] | Temperature characteristics | Capacitance [F] | Capacitance tolerance [%] | tan δ [%] | HTLT              | Thickness*3 [mm] | Soldering R:Reflow W:Wave |
|------------------|---------------|-------------------|-----------------------------|-----------------|---------------------------|-----------|-------------------|------------------|---------------------------|
|                  |               |                   |                             |                 |                           |           | Rated voltage x % |                  |                           |
| UMK316 B7225□D-T |               | 50                | X7R                         | 2.2 μ           | ±10, ±20                  | 10        | 150               | 0.85±0.10        | R                         |
| TMK316AB7475□D-T |               | 25                | X7R                         | 4.7 μ           | ±10, ±20                  | 10        | 150               | 0.85±0.10        | R                         |
| LMK316AB7106MD-T |               | 10                | X7R                         | 10 μ            | ±20                       | 10        | 150               | 0.85±0.10        | R                         |

## ● 325TYPE

## 【Temperature Characteristic BJ : B(-25~+85°C)/X5R(-55~+85°C)】 2.5mm thickness (M)

| Part number 1     | Part number 2    | Rated voltage [V] | Temperature characteristics | Capacitance [F] | Capacitance tolerance [%] | tan δ [%] | HTLT              | Thickness*3 [mm] | Soldering R:Reflow W:Wave |
|-------------------|------------------|-------------------|-----------------------------|-----------------|---------------------------|-----------|-------------------|------------------|---------------------------|
|                   |                  |                   |                             |                 |                           |           | Rated voltage x % |                  |                           |
| UMK325 BJ475□M-P  |                  | 50                | X5R                         | 4.7 μ           | ±10, ±20                  | 5         | 150               | 2.5±0.20         | R                         |
| UMK325 BJ106□M-P  |                  |                   | X5R                         | 10 μ            | ±10, ±20                  | 5         | 150               | 2.5±0.20         | R                         |
| GMK325 BJ226MM-P  |                  | 35                | X5R                         | 22 μ            | ±20                       | 5         | 150               | 2.5±0.20         | R                         |
| TMK325 BJ106□M-P  |                  |                   | B X5R*                      | 10 μ            | ±10, ±20                  | 3.5       | 150               | 2.5±0.20         | R                         |
| TMK325 BJ226□M-P  |                  | 25                | X5R                         | 22 μ            | ±10, ±20                  | 5         | 150               | 2.5±0.20         | R                         |
| TMK325ABJ476MM-P  |                  |                   | X5R                         | 4.7 μ           | ±20                       | 10        | 150               | 2.5±0.30         | R                         |
| EMK325 BJ226□M-P  |                  |                   | B X5R                       | 22 μ            | ±10, ±20                  | 5         | 150               | 2.5±0.20         | R                         |
| EMK325 BJ476MM-P  |                  | 16                | X5R                         | 4.7 μ           | ±20                       | 10        | 150               | 2.5±0.20         | R                         |
| EMK325ABJ107MM-P  |                  |                   | X5R                         | 100 μ           | ±20                       | 10        | 150               | 2.5±0.30         | R                         |
| LMK325 BJ226□M-P  |                  |                   | B X5R                       | 22 μ            | ±10, ±20                  | 5         | 200               | 2.5±0.20         | R                         |
| LMK325 BJ476MM-P  |                  | 10                | X5R                         | 4.7 μ           | ±20                       | 10        | 150               | 2.5±0.20         | R                         |
| LMK325ABJ107MM-P  | LMK325 BJ107MM-P |                   | X5R                         | 100 μ           | ±20                       | 10        | 150               | 2.5±0.30         | R                         |
| LMK325ABJ227MM-PE |                  |                   | X5R                         | 220 μ           | ±20                       | 10        | 150               | 2.5±0.30         | R                         |
| JMK325 BJ476MM-P  |                  | 6.3               | X5R                         | 4.7 μ           | ±20                       | 10        | 150               | 2.5±0.20         | R                         |
| JMK325ABJ107MM-P  | JMK325 BJ107MM-P |                   | X5R                         | 100 μ           | ±20                       | 10        | 150               | 2.5±0.30         | R                         |
| JMK325ABJ157MM-P  |                  |                   | X5R                         | 150 μ           | ±20                       | 10        | 150               | 2.5±0.30         | R                         |
| JMK325ABJ227MM-P  |                  | 4                 | X5R                         | 220 μ           | ±20                       | 10        | 150               | 2.5±0.30         | R                         |
| AMK325ABJ157MM-P  |                  |                   | X5R                         | 150 μ           | ±20                       | 10        | 150               | 2.5±0.30         | R                         |
| AMK325ABJ227MM-P  |                  |                   | X5R                         | 220 μ           | ±20                       | 10        | 150               | 2.5±0.30         | R                         |
| AMK325ABJ337MM-P  |                  |                   | X5R                         | 330 μ           | ±20                       | 10        | 150               | 2.5±0.30         | R                         |

## 【Temperature Characteristic BJ : B(-25~+85°C)/X5R(-55~+85°C)】 1.9mm thickness (Y,N)

| Part number 1    | Part number 2 | Rated voltage [V] | Temperature characteristics | Capacitance [F] | Capacitance tolerance [%] | tan δ [%] | HTLT              | Thickness*3 [mm] | Soldering R:Reflow W:Wave |
|------------------|---------------|-------------------|-----------------------------|-----------------|---------------------------|-----------|-------------------|------------------|---------------------------|
|                  |               |                   |                             |                 |                           |           | Rated voltage x % |                  |                           |
| UMK325 BJ475□N-T |               | 50                | X5R                         | 4.7 μ           | ±10, ±20                  | 10        | 150               | 1.9±0.20         | R                         |
| GMK325 BJ225□N-T |               |                   | B X5R                       | 2.2 μ           | ±10, ±20                  | 3.5       | 200               | 1.9±0.20         | R                         |
| GMK325 BJ475□N-T |               | 35                | X5R                         | 4.7 μ           | ±10, ±20                  | 10        | 150               | 1.9±0.20         | R                         |
| GMK325 BJ106□N-T |               |                   | X5R                         | 10 μ            | ±10, ±20                  | 5         | 150               | 1.9±0.20         | R                         |
| TMK325 BJ335MN-T |               |                   | B X5R*                      | 3.3 μ           | ±20                       | 3.5       | 200               | 1.9±0.20         | R                         |
| TMK325 BJ475□N-T |               | 25                | B X5R*                      | 4.7 μ           | ±10, ±20                  | 3.5       | 200               | 1.9±0.20         | R                         |
| TMK325 BJ106□N-T |               |                   | X5R                         | 10 μ            | ±10, ±20                  | 5         | 200               | 1.9±0.20         | R                         |
| EMK325 BJ475□N-T |               | 16                | B X5R*                      | 4.7 μ           | ±10, ±20                  | 3.5       | 200               | 1.9±0.20         | R                         |
| EMK325 BJ106□N-T |               |                   | X5R                         | 10 μ            | ±10, ±20                  | 3.5       | 200               | 1.9±0.20         | R                         |
| EMK325 BJ476MY-T |               |                   | X5R                         | 4.7 μ           | ±20                       | 10        | 150               | 1.9±0.1/-0.2     | R                         |
| LMK325 BJ226MY-T |               | 10                | B X5R                       | 22 μ            | ±20                       | 5         | 150               | 1.9±0.1/-0.2     | R                         |
| LMK325 BJ106□N-T |               |                   | X5R                         | 10 μ            | ±10, ±20                  | 3.5       | 200               | 1.9±0.20         | R                         |
| JMK325 BJ226MY-T |               | 6.3               | B X5R                       | 22 μ            | ±20                       | 5         | 200               | 1.9±0.1/-0.2     | R                         |
| JMK325 BJ107MY-T |               |                   | X5R                         | 100 μ           | ±20                       | 10        | 150               | 1.9±0.1/-0.2     | R                         |
| JMK325 BJ476MN-T |               |                   | X5R                         | 4.7 μ           | ±20                       | 10        | 150               | 1.9±0.20         | R                         |

## 【Temperature Characteristic BJ : B(-25~+85°C)/X5R(-55~+85°C)】 0.85mm thickness (D)

| Part number 1    | Part number 2 | Rated voltage [V] | Temperature characteristics | Capacitance [F] | Capacitance tolerance [%] | tan δ [%] | HTLT              | Thickness*3 [mm] | Soldering R:Reflow W:Wave |
|------------------|---------------|-------------------|-----------------------------|-----------------|---------------------------|-----------|-------------------|------------------|---------------------------|
|                  |               |                   |                             |                 |                           |           | Rated voltage x % |                  |                           |
| TMK325 BJ106□D-T |               | 25                | X5R                         | 10 μ            | ±10, ±20                  | 5         | 150               | 0.85±0.10        | R                         |
| EMK325 BJ106□D-T |               |                   | X5R                         | 10 μ            | ±10, ±20                  | 5         | 150               | 0.85±0.10        | R                         |
| EMK325 BJ226MD-T |               | 16                | X5R                         | 22 μ            | ±20                       | 10        | 150               | 0.85±0.10        | R                         |
| LMK325 BJ335□D-T |               |                   | B X5R                       | 3.3 μ           | ±10, ±20                  | 3.5       | 200               | 0.85±0.10        | R                         |
| LMK325 BJ475□D-T |               |                   | B X5R                       | 4.7 μ           | ±10, ±20                  | 5         | 200               | 0.85±0.10        | R                         |
| LMK325 BJ106□D-T |               | 10                | X5R                         | 10 μ            | ±10, ±20                  | 5         | 150               | 0.85±0.10        | R                         |
|                  |               |                   | X5R                         | 10 μ            | ±10, ±20                  | 5         | 150               | 0.85±0.10        | R                         |

## 【Temperature Characteristic C6 : X6S(-55~+105°C)】 2.5mm thickness(M)

| Part number 1     | Part number 2 | Rated voltage [V] | Temperature characteristics | Capacitance [F] | Capacitance tolerance [%] | tan δ [%] | HTLT              | Thickness <sup>*3</sup> [mm] | Soldering R:Reflow W:Wave |
|-------------------|---------------|-------------------|-----------------------------|-----------------|---------------------------|-----------|-------------------|------------------------------|---------------------------|
|                   |               |                   |                             |                 |                           |           | Rated voltage x % |                              |                           |
| EMK325AC6476MM-P  |               | 16                | X6S                         | 47 μ            | ±20                       | 10        | 150               | 2.5±0.30                     | R                         |
| LMK325AC6107MM-P  |               | 10                | X6S                         | 100 μ           | ±20                       | 10        | 150               | 2.5±0.30                     | R                         |
| JMK325AC6227MM-PE |               | 6.3               | X6S                         | 220 μ           | ±20                       | 10        | 150               | 2.5±0.30                     | R                         |
| JMK325AC6107MM-P  |               |                   | X6S                         | 100 μ           | ±20                       | 10        | 150               | 2.5±0.30                     | R                         |
| AMK325AC6157MM-P  |               | 4                 | X6S                         | 150 μ           | ±20                       | 10        | 150               | 2.5±0.30                     | R                         |
| AMK325AC6227MM-P  |               |                   | X6S                         | 220 μ           | ±20                       | 10        | 150               | 2.5±0.30                     | R                         |
| PMK325AC6337MM-P  |               | 2.5               | X6S                         | 330 μ           | ±20                       | 10        | 150               | 2.5±0.30                     | R                         |

## 【Temperature Characteristic C7 : X7S(-55~+125°C)】 2.5mm thickness(M)

| Part number 1    | Part number 2 | Rated voltage [V] | Temperature characteristics | Capacitance [F] | Capacitance tolerance [%] | tan δ [%] | HTLT              | Thickness <sup>*3</sup> [mm] | Soldering R:Reflow W:Wave |
|------------------|---------------|-------------------|-----------------------------|-----------------|---------------------------|-----------|-------------------|------------------------------|---------------------------|
|                  |               |                   |                             |                 |                           |           | Rated voltage x % |                              |                           |
| JMK325AC7107MM-P |               | 6.3               | X7S                         | 100 μ           | ±20                       | 10        | 150               | 2.5±0.30                     | R                         |

## 【Temperature Characteristic B7 : X7R(-55~+125°C)】 2.5mm thickness(M)

| Part number 1     | Part number 2 | Rated voltage [V] | Temperature characteristics | Capacitance [F] | Capacitance tolerance [%] | tan δ [%] | HTLT              | Thickness <sup>*3</sup> [mm] | Soldering R:Reflow W:Wave |
|-------------------|---------------|-------------------|-----------------------------|-----------------|---------------------------|-----------|-------------------|------------------------------|---------------------------|
|                   |               |                   |                             |                 |                           |           | Rated voltage x % |                              |                           |
| UMK325 B7335□M-P  |               | 50                | X7R                         | 3.3 μ           | ±10, ±20                  | 3.5       | 200               | 2.5±0.20                     | R                         |
| UMK325 B7475□M-P  |               |                   | X7R                         | 4.7 μ           | ±10, ±20                  | 5         | 150               | 2.5±0.20                     | R                         |
| UMK325AB7106□M-P  |               |                   | X7R                         | 10 μ            | ±10, ±20                  | 10        | 150               | 2.5±0.30                     | R                         |
| TMK325AB7106□M-P  |               | 25                | X7R                         | 10 μ            | ±10, ±20                  | 10        | 200               | 2.5±0.30                     | R                         |
| TMK325 B7226□M-PR |               |                   | X7R                         | 22 μ            | ±10, ±20                  | 10        | 150               | 2.5±0.20                     | R                         |
| EMK325 B7226□M-PR |               | 16                | X7R                         | 22 μ            | ±10, ±20                  | 10        | 150               | 2.5±0.20                     | R                         |
| LMK325 B7476□M-PR |               | 10                | X7R                         | 47 μ            | ±10, ±20                  | 10        | 150               | 2.5±0.20                     | R                         |
| JMK325 B7476□M-PR |               | 6.3               | X7R                         | 47 μ            | ±10, ±20                  | 10        | 200               | 2.5±0.20                     | R                         |

## 【Temperature Characteristic B7 : X7R(-55~+125°C)】 1.9mm thickness(N)

| Part number 1     | Part number 2 | Rated voltage [V] | Temperature characteristics | Capacitance [F] | Capacitance tolerance [%] | tan δ [%] | HTLT              | Thickness <sup>*3</sup> [mm] | Soldering R:Reflow W:Wave |
|-------------------|---------------|-------------------|-----------------------------|-----------------|---------------------------|-----------|-------------------|------------------------------|---------------------------|
|                   |               |                   |                             |                 |                           |           | Rated voltage x % |                              |                           |
| UMK325 B7475□N-TR |               | 50                | X7R                         | 4.7 μ           | ±10, ±20                  | 10        | 150               | 1.9±0.20                     | R                         |
| TMK325 B7335□N-T  |               | 25                | X7R                         | 3.3 μ           | ±10, ±20                  | 3.5       | 200               | 1.9±0.20                     | R                         |
| TMK325 B7475□N-T  |               |                   | X7R                         | 4.7 μ           | ±10, ±20                  | 3.5       | 150               | 1.9±0.20                     | R                         |
| TMK325 B7106□N-TR |               |                   | X7R                         | 10 μ            | ±10, ±20                  | 10        | 150               | 1.9±0.20                     | R                         |
| EMK325 B7475□N-T  |               | 16                | X7R                         | 4.7 μ           | ±10, ±20                  | 3.5       | 200               | 1.9±0.20                     | R                         |
| EMK325 B7106□N-T  |               |                   | X7R                         | 10 μ            | ±10, ±20                  | 3.5       | 150               | 1.9±0.20                     | R                         |
| LMK325 B7106□N-T  |               | 10                | X7R                         | 10 μ            | ±10, ±20                  | 3.5       | 200               | 1.9±0.20                     | R                         |

## ● 432TYPE

## 【Temperature Characteristic BJ : X5R(-55~+85°C)】 2.5mm thickness(M)

| Part number 1    | Part number 2 | Rated voltage [V] | Temperature characteristics | Capacitance [F] | Capacitance tolerance [%] | tan δ [%] | HTLT              | Thickness <sup>*3</sup> [mm] | Soldering R:Reflow W:Wave |
|------------------|---------------|-------------------|-----------------------------|-----------------|---------------------------|-----------|-------------------|------------------------------|---------------------------|
|                  |               |                   |                             |                 |                           |           | Rated voltage x % |                              |                           |
| AMK432 BJ477MM-T |               | 4                 | X5R                         | 470 μ           | ±20                       | 10        | 150               | 2.5±0.20                     | R                         |

## 【Temperature Characteristic C6 : X6S(-55~+105°C)】 2.5mm thickness(M)

| Part number 1    | Part number 2 | Rated voltage [V] | Temperature characteristics | Capacitance [F] | Capacitance tolerance [%] | tan δ [%] | HTLT              | Thickness <sup>*3</sup> [mm] | Soldering R:Reflow W:Wave |
|------------------|---------------|-------------------|-----------------------------|-----------------|---------------------------|-----------|-------------------|------------------------------|---------------------------|
|                  |               |                   |                             |                 |                           |           | Rated voltage x % |                              |                           |
| PMK432 C6477MM-T |               | 2.5               | X6S                         | 470 μ           | ±20                       | 10        | 150               | 2.5±0.20                     | R                         |

▶ This catalog contains the typical specification only due to the limitation of space. When you consider the purchase of our products, please check our product specification sheets. For details of each product (characteristics graph, reliability information, precautions for use, and so on), see our website (<http://www.ty-top.com/>).

# Multilayer Ceramic Capacitors

## PACKAGING

### ① Minimum Quantity

#### ● Taped package

| Type(EIA)  | Thickness |      | Standard quantity [pcs] |                 |
|--|-----------|------|-------------------------|-----------------|
|  | mm        | code | Paper tape              | Embossed tape   |
| <input type="checkbox"/> MK021(008004)                                       | 0.125     | K    | —                       | 50000           |
| <input type="checkbox"/> VS021(008004)                                       |           |      |                         |                 |
| <input type="checkbox"/> MK042(01005)  | 0.2       | C, D | —                       | 40000           |
| <input type="checkbox"/> VS042(01005)  |           |      |                         |                 |
| <input type="checkbox"/> MK063(0201)   | 0.3       | P, T | 15000                   | —               |
| <input type="checkbox"/> WK105(0204) ※                                       | 0.3       | P    | 10000                   | —               |
| <input type="checkbox"/> MK105(0402)<br><input type="checkbox"/> MF105(0402) | 0.13      | H    | —                       | 20000           |
|  | 0.18      | E    | —                       | 15000           |
|  | 0.2       | C    | 20000                   | —               |
|  | 0.3       | P    | 15000                   | —               |
|  | 0.5       | V    | 10000                   | —               |
| <input type="checkbox"/> VK105(0402)   | 0.5       | W    | 10000                   | —               |
| <input type="checkbox"/> MK107(0603)   | 0.45      | K    | 4000                    | —               |
| <input type="checkbox"/> WK107(0306) ※                                       | 0.5       | V    | —                       | 4000            |
| <input type="checkbox"/> MF107(0603)   | 0.8       | A    | 4000                    | —               |
| <input type="checkbox"/> VS107(0603)   | 0.7       | C    | 4000                    | —               |
| <input type="checkbox"/> MJ107(0603)   | 0.8       | A    | 3000                    | 3000            |
| <input type="checkbox"/> MK212(0805)   | 0.45      | K    | 4000                    | —               |
| <input type="checkbox"/> WK212(0508) ※                                       | 0.85      | D    |                         |                 |
| <input type="checkbox"/> MF212(0805)   | 1.25      | G    | —                       | 3000            |
| <input type="checkbox"/> VS212(0805)   | 0.85      | D    | 4000                    | —               |
| <input type="checkbox"/> MJ212(0805)   | 0.85      | D    | 4000                    | —               |
|  | 1.25      | G    | —                       | 2000            |
| <input type="checkbox"/> MK316(1206)<br><input type="checkbox"/> MF316(1206) | 0.85      | D    | 4000                    | —               |
|  | 1.15      | F    | —                       | 3000            |
|  | 1.6       | L    | —                       | 2000            |
| <input type="checkbox"/> MJ316(1206)   | 1.15      | F    | —                       | 3000            |
|  | 1.6       | L    | —                       | 2000            |
| <input type="checkbox"/> MK325(1210)<br><input type="checkbox"/> MF325(1210) | 0.85      | D    | —                       | 2000            |
|  | 1.15      | F    |                         |                 |
|  | 1.9       | N    |                         |                 |
|  | 2.0max.   | Y    |                         |                 |
| <input type="checkbox"/> MJ325(1210)   | 2.5       | M    | —                       | 1000            |
|  | 1.9       | N    | —                       | 2000            |
|  | 2.5       | M    | —                       | 500(T), 1000(P) |
| <input type="checkbox"/> MK432(1812)   | 2.5       | M    | —                       | 500             |

Note : ※ LW Reverse type.

### ② Taping material

※No bottom tape for pressed carrier tape

#### ● Card board carrier tape

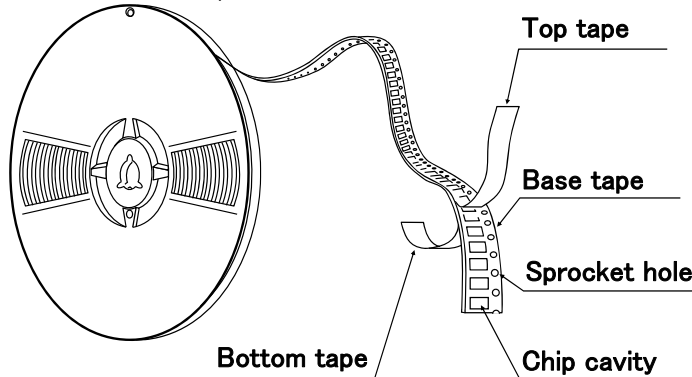

#### ● Embossed tape

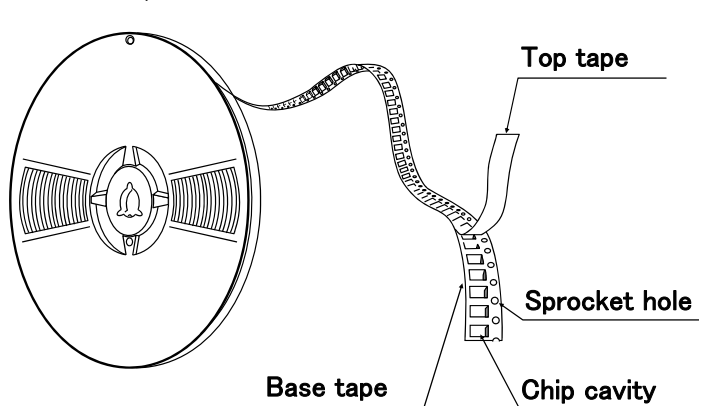

▶ This catalog contains the typical specification only due to the limitation of space. When you consider the purchase of our products, please check our specification. For details of each product (characteristics graph, reliability information, precautions for use, and so on), see our Web site (<http://www.ty-top.com/>).



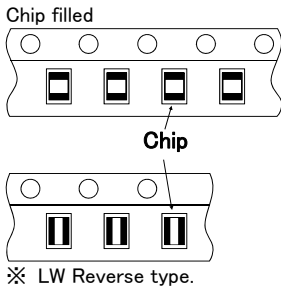

### ③ Representative taping dimensions

● Paper Tape (8mm wide)

● Pressed carrier tape ( 2mm pitch)

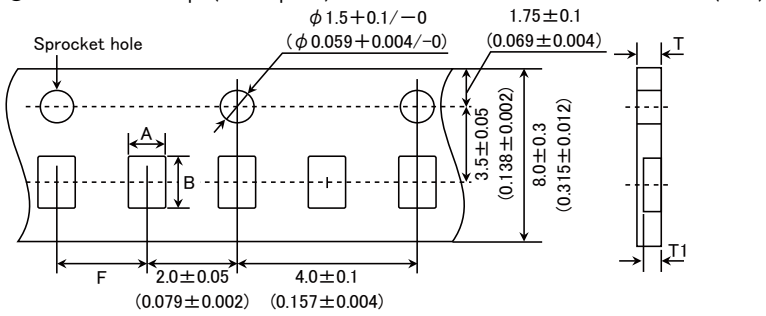

| Type(EIA)           | Chip Cavity |      | Insertion Pitch<br>F | Tape Thickness |          |
|---------------------|-------------|------|----------------------|----------------|----------|
|                     | A           | B    |                      | T              | T1       |
| □MK063(0201)        | 0.37        | 0.67 | 2.0±0.05             | 0.45max.       | 0.42max. |
| □WK105(0204) ※      | 0.65        | 1.15 |                      | 0.4max.        | 0.3max.  |
| □MK105(0402) (*1 C) |             |      |                      | 0.45max.       | 0.42max. |
| □MK105(0402) (*1 P) |             |      |                      |                |          |

Note \*1 Thickness, C: 0.2mm ,P: 0.3mm. ※ LW Reverse type.

Unit: mm

● Punched carrier tape (2mm pitch)

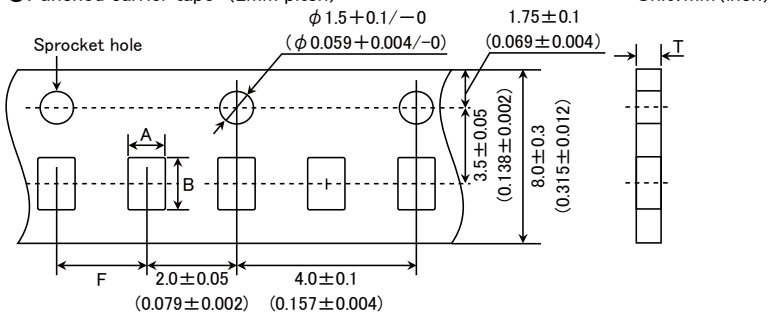

| Type(EIA)     | Chip Cavity |      | Insertion Pitch<br>F | Tape Thickness |
|---------------|-------------|------|----------------------|----------------|
|               | A           | B    |                      | T              |
| □MK105 (0402) | 0.65        | 1.15 | 2.0±0.05             | 0.8max.        |
| □MF105 (0402) |             |      |                      |                |
| □VK105 (0402) |             |      |                      |                |

Unit: mm

● Punched carrier tape (4mm pitch)

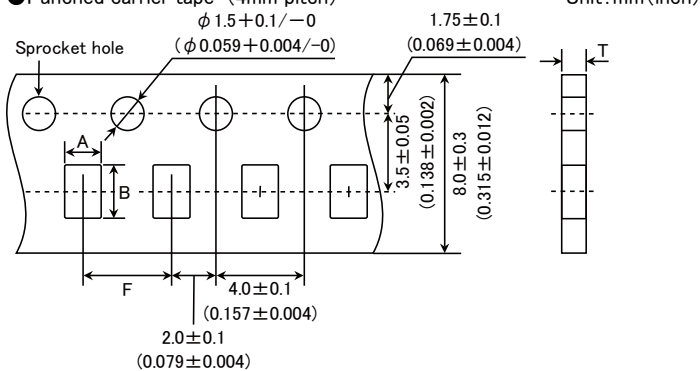

▶ This catalog contains the typical specification only due to the limitation of space. When you consider the purchase of our products, please check our specification. For details of each product (characteristics graph, reliability information, precautions for use, and so on), see our Web site (<http://www.ty-top.com/>).



| Type(EIA)                                      | Chip Cavity |     | Insertion Pitch | Tape Thickness |   |
|--|-------------|-----|-----------------|----------------|---|
|  | A           | B   |                 | F              | T |
| □MK107(0603)<br>□WK107(0306) ※<br>□MF107(0603) | 1.0         | 1.8 | 4.0±0.1         | 1.1max.        |   |
| □MK212(0805)<br>□WK212(0508) ※                 | 1.65        | 2.4 |                 | 1.1max.        |   |
| □MK316(1206)                                   | 2.0         | 3.6 |                 |                |   |

Note: Taping size might be different depending on the size of the product. ※ LW Reverse type.

Unit: mm

● Embossed tape (4mm wide)

Unit: mm (inch)

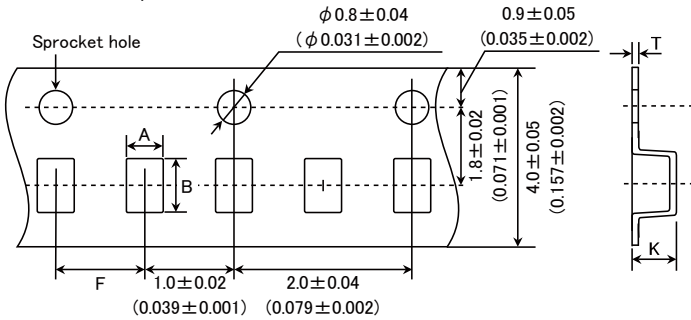

| Type(EIA)                        | Chip Cavity |      | Insertion Pitch | Tape Thickness |          |
|----------------------------------|-------------|------|-----------------|----------------|----------|
|                                  | A           | B    |                 | K              | T        |
| □MK021(008004)<br>□VS021(008004) | 0.135       | 0.27 | 1.0±0.02        | 0.5max.        | 0.25max. |
| □MK042(01005)<br>□VS042(01005)   |             |      |                 |                |          |

Unit: mm

● Embossed tape (8mm wide)

Unit: mm (inch)

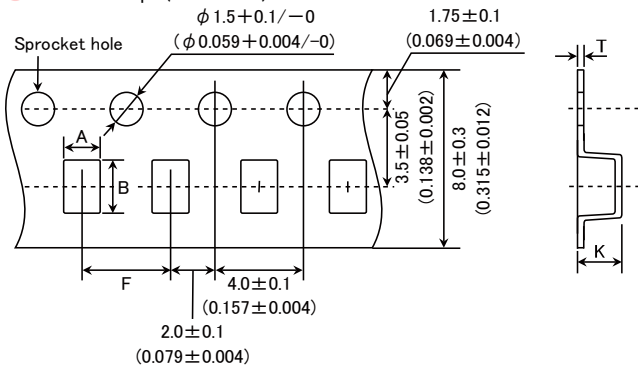

| Type(EIA)                                      | Chip Cavity |     | Insertion Pitch | Tape Thickness |          |
|--|-------------|-----|-----------------|----------------|----------|
|  | A           | B   |                 | K              | T        |
| □MK105(0402)                                   | 0.6         | 1.1 | 2.0±0.1         | 0.6max         | 0.2±0.1  |
| □WK107(0306) ※<br>□MK212(0805)<br>□MF212(0805) | 1.0         | 1.8 | 4.0±0.1         | 1.3max.        | 0.25±0.1 |
| □MK316(1206)<br>□MF316(1206)                   | 2.0         | 3.6 |                 | 3.4max.        | 0.6max.  |
| □MK325(1210)<br>□MF325(1210)                   | 2.8         | 3.6 |                 |                |          |

Note: ※ LW Reverse type.

Unit: mm

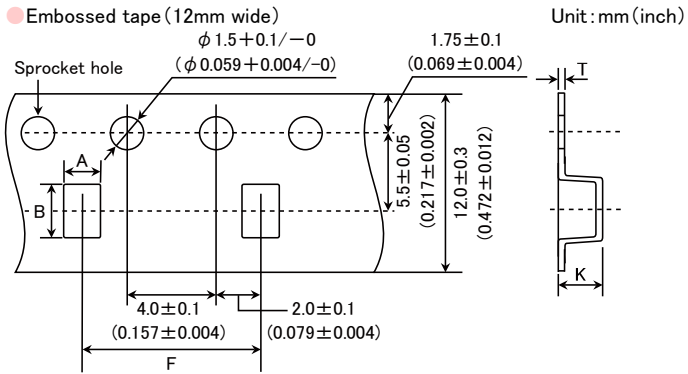

| Type(EIA)    | Chip Cavity |     | Insertion Pitch | Tape Thickness |         |
|--------------|-------------|-----|-----------------|----------------|---------|
|              | A           | B   | F               | K              | T       |
| □MK325(1210) | 3.1         | 4.0 | 8.0±0.1         | 4.0max.        | 0.6max. |
| □MK432(1812) | 3.7         | 4.9 | 8.0±0.1         | 4.0max.        | 0.6max. |

Unit: mm

#### ④Trailer and Leader

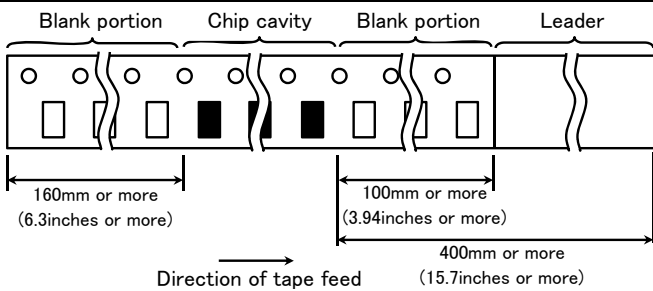

#### ⑤Reel size

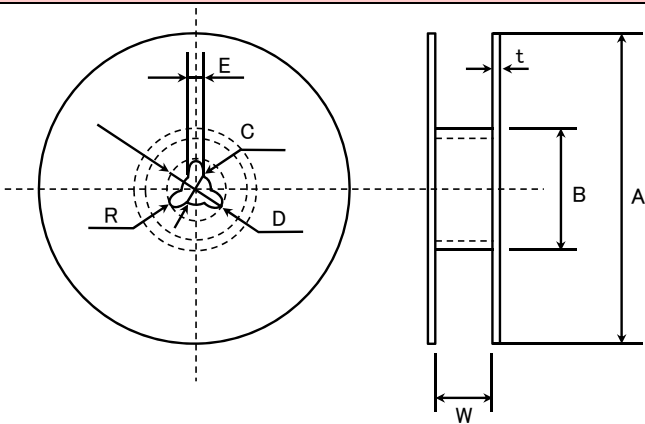

| A                  | B                      | C                   | D                   | E             | R   |
|--------------------|------------------------|---------------------|---------------------|---------------|-----|
| $\phi 178 \pm 2.0$ | $\phi 50 \text{ min.}$ | $\phi 13.0 \pm 0.2$ | $\phi 21.0 \pm 0.8$ | $2.0 \pm 0.5$ | 1.0 |
|                    | T                      | W                   |                     |               |     |
| 4mm wide tape      | 1.5max.                | $5 \pm 1.0$         |                     |               |     |
| 8mm wide tape      | 2.5max.                | $10 \pm 1.5$        |                     |               |     |
| 12mm wide tape     | 2.5max.                | $14 \pm 1.5$        |                     |               |     |

Unit: mm

#### ⑥Top Tape Strength

The top tape requires a peel-off force of 0.1 to 0.7N in the direction of the arrow as illustrated below.

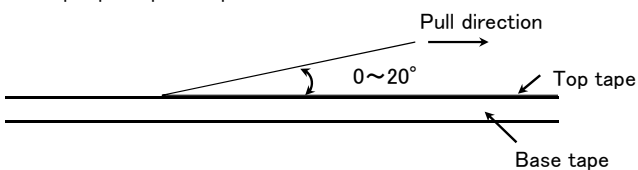

# Multilayer Ceramic Capacitors

## RELIABILITY DATA

### 1. Operating Temperature Range

|  |                                  |                     |               |                   |  |
|--|----------------------------------|---------------------|---------------|-------------------|--|
| Specified Value  | Temperature Compensating(Class1) | Standard            | -55 to +125°C |                   |  |
|  |                                  | High Frequency Type |               |                   |  |
| Specified Value  | High Permittivity (Class2)       |                     | Specification | Temperature Range |  |
|  |                                  | BJ                  | B             | -25 to +85°C      |  |
|  |                                  |                     | X5R           | -55 to +85°C      |  |
|  |                                  | B7                  | X7R           | -55 to +125°C     |  |
|  |                                  | C6                  | X6S           | -55 to +105°C     |  |
|  |                                  | C7                  | X7S           | -55 to +125°C     |  |
|  | LD(※)                            | X5R                 | -55 to +85°C  |                   |  |
| Note: ※LD Low distortion high value multilayer ceramic capacitor |                                  |                     |               |                   |  |

### 2. Storage Conditions

|  |                                  |                     |               |                   |  |
|--|----------------------------------|---------------------|---------------|-------------------|--|
| Specified Value  | Temperature Compensating(Class1) | Standard            | -55 to +125°C |                   |  |
|  |                                  | High Frequency Type |               |                   |  |
| Specified Value  | High Permittivity (Class2)       |                     | Specification | Temperature Range |  |
|  |                                  | BJ                  | B             | -25 to +85°C      |  |
|  |                                  |                     | X5R           | -55 to +85°C      |  |
|  |                                  | B7                  | X7R           | -55 to +125°C     |  |
|  |                                  | C6                  | X6S           | -55 to +105°C     |  |
|  |                                  | C7                  | X7S           | -55 to +125°C     |  |
|  | LD(※)                            | X5R                 | -55 to +85°C  |                   |  |
| Note: ※LD Low distortion high value multilayer ceramic capacitor |                                  |                     |               |                   |  |

### 3. Rated Voltage

|                 |                                  |                     |   |
|-----------------|----------------------------------|---------------------|---|
| Specified Value | Temperature Compensating(Class1) | Standard            | 50VDC, 25VDC, 16VDC                                     |
|                 |                                  | High Frequency Type | 50VDC, 25VDC, 16VDC                                     |
|                 | High Permittivity (Class2)       |                     | 50VDC, 35VDC, 25VDC, 16VDC, 10VDC, 6.3VDC, 4VDC, 2.5VDC |

### 4. Withstanding Voltage (Between terminals)

|                          |                                  |                     |                        |                     |
|--------------------------|----------------------------------|---------------------|------------------------|---------------------|
| Specified Value          | Temperature Compensating(Class1) | Standard            | No breakdown or damage |                     |
|                          |                                  | High Frequency Type |                        |                     |
| Test Methods and Remarks | High Permittivity (Class2)       |                     | Class 1                | Class 2             |
|                          | Applied voltage                  |                     | Rated voltage × 3      | Rated voltage × 2.5 |
|                          | Duration                         |                     | 1 to 5 sec.            |                     |
|                          | Charge/discharge current         |                     | 50mA max.              |                     |

### 5. Insulation Resistance

|                          |                                   |                     |   |
|--------------------------|-----------------------------------|---------------------|---|
| Specified Value          | Temperature Compensating(Class1)  | Standard            | 10000 MΩ min.   |
|                          |                                   | High Frequency Type |   |
|                          | High Permittivity (Class2) Note 1 |                     | C ≤ 0.047 μF : 10000 MΩ min.<br>C > 0.047 μF : 500MΩ·μF |
| Test Methods and Remarks | Applied voltage                   | : Rated voltage     |   |
|                          | Duration                          | : 60 ± 5 sec.       |   |
|                          | Charge/discharge current          | : 50mA max.         |   |

▶ This catalog contains the typical specification only due to the limitation of space. When you consider the purchase of our products, please check our specification. For details of each product (characteristics graph, reliability information, precautions for use, and so on), see our Web site (<http://www.ty-top.com/>).

| 6. Capacitance (Tolerance) |                                  |                        |                 |                           |   |               |
|----------------------------|----------------------------------|------------------------|-----------------|---------------------------|---|---------------|
| Specified Value            | Temperature Compensating(Class1) | Standard               | C□              | 0.2pF ≤ C ≤ 5pF : ±0.25pF |   |               |
|                            |                                  |                        | U□              | 0.2pF ≤ C ≤ 10pF : ±0.5pF |   |               |
|                            | SL                               | C > 10pF : ±5% or ±10% |                 |                           |   |               |
| High Permittivity (Class2) | High Frequency Type              | CG                     | 0.2pF ≤ C ≤ 2pF | : ±0.1pF                  |   |               |
|                            |                                  |                        | C > 2pF         | : ±5%                     |   |               |
| High Permittivity (Class2) |                                  | ±10% or ±20%           |                 |                           |   |               |
| Test Methods and Remarks   |                                  |                        | Class 1         |                           | Class 2                                     |               |
|                            |                                  |                        | Standard        | High Frequency Type       | C ≤ 10 μF                                   | C > 10 μF     |
|                            | Preconditioning                  |                        | None            |                           | Thermal treatment (at 150°C for 1hr) Note 2 |               |
|                            | Measuring frequency              |                        | 1MHz ± 10%      |                           | 1kHz ± 10%                                  | 120 ± 10Hz    |
|                            | Measuring voltage Nte            |                        | 0.5 to 5Vrms    |                           | 1 ± 0.2Vrms                                 | 0.5 ± 0.1Vrms |
| Bias application           |                                  | None                   |                 |                           |   |               |

| 7. Q or Dissipation Factor        |                                  |                                 |  |                     |   |               |
|-----------------------------------|----------------------------------|---------------------------------|--|---------------------|---|---------------|
| Specified Value                   | Temperature Compensating(Class1) | Standard                        | C < 30pF : Q ≥ 400 + 20C                     |                     |   |               |
|                                   |                                  |                                 | C ≥ 30pF : Q ≥ 1000 (C: Nominal capacitance) |                     |   |               |
|                                   | High Frequency Type              | Refer to detailed specification |  |                     |   |               |
| High Permittivity (Class2) Note 1 |                                  | BJ, B7, C6, C7: 2.5% max.       |  |                     |   |               |
| Test Methods and Remarks          |                                  |                                 | Class 1                                      |                     | Class 2                                     |               |
|                                   |                                  |                                 | Standard                                     | High Frequency Type | C ≤ 10 μF                                   | C > 10 μF     |
|                                   | Preconditioning                  |                                 | None   |                     | Thermal treatment (at 150°C for 1hr) Note 2 |               |
|                                   | Measuring frequency              |                                 | 1MHz ± 10%                                   |                     | 1kHz ± 10%                                  | 120 ± 10Hz    |
|                                   | Measuring voltage Note 1         |                                 | 0.5 to 5Vrms                                 |                     | 1 ± 0.2Vrms                                 | 0.5 ± 0.1Vrms |
| Bias application                  |                                  | None                            |  |                     |   |               |
| High Frequency Type               |                                  | Measuring equipment : HP4291A   |  |                     |   |               |
|                                   |                                  | Measuring jig : HP16192A        |  |                     |   |               |

| 8. Temperature Characteristic (Without voltage application) |                                  |   |   |   |                      |                       |                   |
|---|----------------------------------|---|---|---|----------------------|-----------------------|-------------------|
| Specified Value   | Temperature Compensating(Class1) | Standard  | Temperature Characteristic [ppm/°C]   |   | Tolerance [ppm/°C]   |                       |                   |
|   |                                  |   | C□ : 0  | CG  | G : ±30              |                       |                   |
|   |                                  |   | U□ : -750   | UJ, UK  | J : ±120<br>K : ±250 |                       |                   |
| High Permittivity (Class2)                                  |                                  | High Frequency Type   | Temperature Characteristic [ppm/°C]   |   | Tolerance [ppm/°C]   |                       |                   |
|   |                                  |   | C□ : 0  |   | G : ±30              |                       |                   |
|   |                                  |   | SL : +350 to -1000  |   |                      |                       |                   |
| Test Methods and Remarks                                    | High Permittivity (Class2)       |   |   | Specification   | Capacitance change   | Reference temperature | Temperature Range |
|   |                                  |   | BJ  | B   | ±10%                 | 20°C                  | -25 to +85°C      |
|   |                                  |   |   | X5R   | ±15%                 | 25°C                  | -55 to +85°C      |
|   |                                  |   | B7  | X7R   | ±15%                 | 25°C                  | -55 to +125°C     |
|   |                                  |   | C6  | XS  | ±22%                 | 25°C                  | -55 to +105°C     |
|   |                                  |   | C7  | X7S   | ±22%                 | 25°C                  | -55 to +125°C     |
|   |                                  |   | LD(※)   | X5R   | ±15%                 | 25°C                  | -55 to +85°C      |
|   |                                  |   | Note : ※LD Low distortion high value multilayer ceramic capacitor   |   |                      |                       |                   |
|   |                                  |   | Class 1<br>Capacitance at 20°C and 85°C shall be measured in thermal equilibrium, and the temperature characteristic shall be calculated from the following equation. |   |                      |                       |                   |
|   |                                  |   | $\frac{(C_{85} - C_{20})}{C_{20} \times \Delta T} \times 10^6 (\text{ppm}/^\circ\text{C}) \quad \Delta T = 65$  |   |                      |                       |                   |
|   |                                  | Class 2<br>Capacitance at each step shall be measured in thermal equilibrium, and the temperature characteristic shall be calculated from the following equation. |   |   |                      |                       |                   |
|   |                                  | Step  | B   | X5R, X7R, X6S, X7S  |                      |                       |                   |
|   |                                  | 1   | Minimum operating temperature   |   |                      |                       |                   |
|   |                                  | 2   | 20°C  | 25°C  |                      |                       |                   |
|   |                                  | 3   | Maximum operating temperature   |   |                      |                       |                   |
|   |                                  | $\frac{(C - C_2)}{C_2} \times 100 (\%)$   |   | C : Capacitance in Step 1 or Step 3<br>C <sub>2</sub> : Capacitance in Step 2 |                      |                       |                   |

▶ This catalog contains the typical specification only due to the limitation of space. When you consider the purchase of our products, please check our specification. For details of each product (characteristics graph, reliability information, precautions for use, and so on), see our Web site (<http://www.ty-top.com/>).

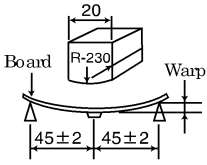
| 9. Deflection            |  |                               |  |                               |  |                          |                 |       |                             |  |           |       |       |      |     |  |          |         |  |   |
|--------------------------|--|-------------------------------|--|-------------------------------|--|--------------------------|-----------------|-------|-----------------------------|--|-----------|-------|-------|------|-----|--|----------|---------|--|---|
| Specified Value          | Temperature Compensating(Class1)   | Standard                      | Appearance : No abnormality<br>Capacitance change : Within $\pm 5\%$ or $\pm 0.5$ pF, whichever is larger. |                               |  |                          |                 |       |                             |  |           |       |       |      |     |  |          |         |  |   |
|                          |  | High Frequency Type           | Appearance : No abnormality<br>Capacitance change : Within $\pm 0.5$ pF                                    |                               |  |                          |                 |       |                             |  |           |       |       |      |     |  |          |         |  |   |
|                          | High Permittivity (Class2)   |                               | Appearance : No abnormality<br>Capacitance change : Within $\pm 12.5\%$                                    |                               |  |                          |                 |       |                             |  |           |       |       |      |     |  |          |         |  |   |
| Test Methods and Remarks | <table border="1"> <thead> <tr> <th rowspan="2"></th> <th colspan="2">Multilayer Ceramic Capacitors</th> </tr> <tr> <th>021, 042, 063, *105 Type</th> <th>The other types</th> </tr> </thead> <tbody> <tr> <td>Board</td> <td colspan="2">Glass epoxy-resin substrate</td> </tr> <tr> <td>Thickness</td> <td>0.8mm</td> <td>1.6mm</td> </tr> <tr> <td>Warp</td> <td colspan="2">1mm</td> </tr> <tr> <td>Duration</td> <td colspan="2">10 sec.</td> </tr> </tbody> </table> <p>*105 Type thickness, C: 0.2mm ,P: 0.3mm.</p> |                               |  | Multilayer Ceramic Capacitors |  | 021, 042, 063, *105 Type | The other types | Board | Glass epoxy-resin substrate |  | Thickness | 0.8mm | 1.6mm | Warp | 1mm |  | Duration | 10 sec. |  |  <p>(Unit: mm)</p> <p>Capacitance measurement shall be conducted with the board bent</p> |
|                          |  | Multilayer Ceramic Capacitors |  |                               |  |                          |                 |       |                             |  |           |       |       |      |     |  |          |         |  |   |
| 021, 042, 063, *105 Type |  | The other types               |  |                               |  |                          |                 |       |                             |  |           |       |       |      |     |  |          |         |  |   |
| Board                    | Glass epoxy-resin substrate  |                               |  |                               |  |                          |                 |       |                             |  |           |       |       |      |     |  |          |         |  |   |
| Thickness                | 0.8mm  | 1.6mm                         |  |                               |  |                          |                 |       |                             |  |           |       |       |      |     |  |          |         |  |   |
| Warp                     | 1mm  |                               |  |                               |  |                          |                 |       |                             |  |           |       |       |      |     |  |          |         |  |   |
| Duration                 | 10 sec.  |                               |  |                               |  |                          |                 |       |                             |  |           |       |       |      |     |  |          |         |  |   |
|                          |  |                               |  |                               |  |                          |                 |       |                             |  |           |       |       |      |     |  |          |         |  |   |

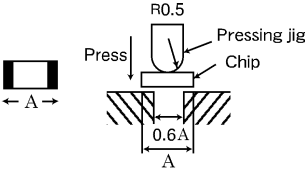
| 10. Body Strength        |  |                     |   |
|--------------------------|--|---------------------|---|
| Specified Value          | Temperature Compensating(Class1)                                   | Standard            | —   |
|                          |  | High Frequency Type | No mechanical damage.   |
|                          | High Permittivity (Class2)   |                     | —   |
| Test Methods and Remarks | High Frequency 105Type<br>Applied force : 5N<br>Duration : 10 sec. |                     |  |
|                          |  |                     |   |

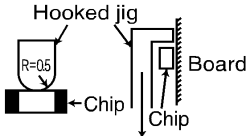
| 11. Adhesive Strength of Terminal Electrodes |   |                               |   |                               |  |                    |                  |               |    |    |          |                 |  |  |
|--|---|-------------------------------|---|-------------------------------|--|--------------------|------------------|---------------|----|----|----------|-----------------|--|--|
| Specified Value                              | Temperature Compensating(Class1)  | Standard                      | No terminal separation or its indication. |                               |  |                    |                  |               |    |    |          |                 |  |  |
|  |   | High Frequency Type           |   |                               |  |                    |                  |               |    |    |          |                 |  |  |
|  | High Permittivity (Class2)  |                               |   |                               |  |                    |                  |               |    |    |          |                 |  |  |
| Test Methods and Remarks                     | <table border="1"> <thead> <tr> <th rowspan="2"></th> <th colspan="2">Multilayer Ceramic Capacitors</th> </tr> <tr> <th>021, 042, 063 Type</th> <th>105 Type or more</th> </tr> </thead> <tbody> <tr> <td>Applied force</td> <td>2N</td> <td>5N</td> </tr> <tr> <td>Duration</td> <td colspan="2">30<math>\pm</math>5 sec.</td> </tr> </tbody> </table> |                               |   | Multilayer Ceramic Capacitors |  | 021, 042, 063 Type | 105 Type or more | Applied force | 2N | 5N | Duration | 30 $\pm$ 5 sec. |  |  |
|  |   | Multilayer Ceramic Capacitors |   |                               |  |                    |                  |               |    |    |          |                 |  |  |
|  |   | 021, 042, 063 Type            | 105 Type or more                          |                               |  |                    |                  |               |    |    |          |                 |  |  |
| Applied force                                | 2N  | 5N                            |   |                               |  |                    |                  |               |    |    |          |                 |  |  |
| Duration                                     | 30 $\pm$ 5 sec.   |                               |   |                               |  |                    |                  |               |    |    |          |                 |  |  |
|  |   |                               |   |                               |  |                    |                  |               |    |    |          |                 |  |  |

| 12. Solderability        |  |                          |  |                 |                  |             |              |                |                    |                          |                          |          |                |  |  |
|--------------------------|--|--------------------------|--|-----------------|------------------|-------------|--------------|----------------|--------------------|--------------------------|--------------------------|----------|----------------|--|--|
| Specified Value          | Temperature Compensating(Class1)   | Standard                 | At least 95% of terminal electrode is covered by new solder. |                 |                  |             |              |                |                    |                          |                          |          |                |  |  |
|                          |  | High Frequency Type      |  |                 |                  |             |              |                |                    |                          |                          |          |                |  |  |
|                          | High Permittivity (Class2)   |                          |  |                 |                  |             |              |                |                    |                          |                          |          |                |  |  |
| Test Methods and Remarks | <table border="1"> <thead> <tr> <th></th> <th>Eutectic solder</th> <th>Lead-free solder</th> </tr> </thead> <tbody> <tr> <td>Solder type</td> <td>H60A or H63A</td> <td>Sn-3.0Ag-0.5Cu</td> </tr> <tr> <td>Solder temperature</td> <td>230<math>\pm</math>5<math>^{\circ}</math>C</td> <td>245<math>\pm</math>3<math>^{\circ}</math>C</td> </tr> <tr> <td>Duration</td> <td colspan="2">4<math>\pm</math>1 sec.</td> </tr> </tbody> </table> |                          |  | Eutectic solder | Lead-free solder | Solder type | H60A or H63A | Sn-3.0Ag-0.5Cu | Solder temperature | 230 $\pm$ 5 $^{\circ}$ C | 245 $\pm$ 3 $^{\circ}$ C | Duration | 4 $\pm$ 1 sec. |  |  |
|                          |  | Eutectic solder          | Lead-free solder   |                 |                  |             |              |                |                    |                          |                          |          |                |  |  |
|                          | Solder type  | H60A or H63A             | Sn-3.0Ag-0.5Cu   |                 |                  |             |              |                |                    |                          |                          |          |                |  |  |
|                          | Solder temperature   | 230 $\pm$ 5 $^{\circ}$ C | 245 $\pm$ 3 $^{\circ}$ C                                     |                 |                  |             |              |                |                    |                          |                          |          |                |  |  |
| Duration                 | 4 $\pm$ 1 sec.   |                          |  |                 |                  |             |              |                |                    |                          |                          |          |                |  |  |
|                          |  |                          |  |                 |                  |             |              |                |                    |                          |                          |          |                |  |  |
|                          |  |                          |  |                 |                  |             |              |                |                    |                          |                          |          |                |  |  |

► This catalog contains the typical specification only due to the limitation of space. When you consider the purchase of our products, please check our specification. For details of each product (characteristics graph, reliability information, precautions for use, and so on), see our Web site (<http://www.ty-top.com/>).

**13. Resistance to Soldering**

|                 |                                   |                     |   |
|-----------------|-----------------------------------|---------------------|---|
| Specified Value | Temperature Compensating(Class1)  | Standard            | Appearance : No abnormality<br>Capacitance change : Within $\pm 2.5\%$ or $\pm 0.25\text{pF}$ , whichever is larger.<br>Q : Initial value<br>Insulation resistance : Initial value<br>Withstanding voltage (between terminals) : No abnormality |
|                 |                                   | High Frequency Type | Appearance : No abnormality<br>Capacitance change : Within $\pm 2.5\%$<br>Q : Initial value<br>Insulation resistance : Initial value<br>Withstanding voltage (between terminals) : No abnormality   |
|                 | High Permittivity (Class2) Note 1 |                     | Appearance : No abnormality<br>Capacitance change : Within $\pm 7.5\%$<br>Dissipation factor : Initial value<br>Insulation resistance : Initial value<br>Withstanding voltage (between terminals): No abnormality                               |

|                          |                 |  |   |   |
|--------------------------|-----------------|--|---|---|
| Test Methods and Remarks | Class 1         |  |   |   |
|                          |                 | 021, 042, 063 Type                           | 105 Type  |   |
|                          | Preconditioning | None   |   |   |
|                          | Preheating      | 150°C, 1 to 2 min.                           | 80 to 100°C, 2 to 5 min.<br>150 to 200°C, 2 to 5 min. |   |
|                          | Solder temp.    | 270 $\pm$ 5°C                                |   |   |
|                          | Duration        | 3 $\pm$ 0.5 sec.                             |   |   |
|                          | Recovery        | 6 to 24 hrs (Standard condition) Note 5      |   |   |
|                          | Class 2         |  |   |   |
|                          |                 | 021, 042, 063 Type                           | 105, 107, 212 Type                                    | 316, 325, 432 Type                                      |
|                          | Preconditioning | Thermal treatment (at 150°C for 1 hr) Note 2 |   |   |
|                          | Preheating      | 150°C, 1 to 2 min.                           | 80 to 100°C, 2 to 5 min.<br>150 to 200°C, 2 to 5 min. | 80 to 100°C, 5 to 10 min.<br>150 to 200°C, 5 to 10 min. |
|                          | Solder temp.    | 270 $\pm$ 5°C                                |   |   |
|                          | Duration        | 3 $\pm$ 0.5 sec.                             |   |   |
|                          | Recovery        | 24 $\pm$ 2 hrs (Standard condition) Note 5   |   |   |

**14. Temperature Cycle (Thermal Shock)**

|                 |                                   |                     |   |
|-----------------|-----------------------------------|---------------------|---|
| Specified Value | Temperature Compensating(Class1)  | Standard            | Appearance : No abnormality<br>Capacitance change : Within $\pm 2.5\%$ or $\pm 0.25\text{pF}$ , whichever is larger.<br>Q : Initial value<br>Insulation resistance : Initial value<br>Withstanding voltage (between terminals) : No abnormality |
|                 |                                   | High Frequency Type | Appearance : No abnormality<br>Capacitance change : Within $\pm 0.25\text{pF}$<br>Q : Initial value<br>Insulation resistance : Initial value<br>Withstanding voltage (between terminals) : No abnormality                                       |
|                 | High Permittivity (Class2) Note 1 |                     | Appearance : No abnormality<br>Capacitance change : Within $\pm 7.5\%$<br>Dissipation factor : Initial value<br>Insulation resistance : Initial value<br>Withstanding voltage (between terminals) : No abnormality                              |

|                          |   |                               |  |  |  |
|--------------------------|---|-------------------------------|--|--|--|
| Test Methods and Remarks | Class 1                                 |                               | Class 2                                    |  |  |
|                          | Preconditioning                         | None                          |  | Thermal treatment (at 150°C for 1 hr) Note 2 |  |
|                          | 1 cycle                                 | Step                          | Temperature (°C)                           | Time (min.)                                  |  |
|                          |   | 1                             | Minimum operating temperature              | 30 $\pm$ 3                                   |  |
|                          |   | 2                             | Normal temperature                         | 2 to 3                                       |  |
| 3                        |   | Maximum operating temperature | 30 $\pm$ 3                                 |  |  |
| 4                        | Normal temperature                      | 2 to 3                        |  |  |  |
| Number of cycles         | 5 times                                 |                               |  |  |  |
| Recovery                 | 6 to 24 hrs (Standard condition) Note 5 |                               | 24 $\pm$ 2 hrs (Standard condition) Note 5 |  |  |

▶ This catalog contains the typical specification only due to the limitation of space. When you consider the purchase of our products, please check our specification. For details of each product (characteristics graph, reliability information, precautions for use, and so on), see our Web site (<http://www.ty-top.com/>).

15. Humidity (Steady State)

|                 |                                   |                     |   |
|-----------------|-----------------------------------|---------------------|---|
| Specified Value | Temperature Compensating(Class1)  | Standard            | Appearance : No abnormality<br>Capacitance change : Within $\pm 5\%$ or $\pm 0.5\text{pF}$ , whichever is larger.<br>Q : $C < 10\text{pF} : Q \geq 200 + 10C$<br>$10 \leq C < 30\text{pF} : Q \geq 275 + 2.5C$<br>$C \geq 30\text{pF} : Q \geq 350 (C : \text{Nominal capacitance})$<br>Insulation resistance : $1000 \text{ M}\Omega \text{ min.}$ |
|                 |                                   | High Frequency Type | Appearance : No abnormality<br>Capacitance change : Within $\pm 0.5\text{pF}$ ,<br>Insulation resistance : $1000 \text{ M}\Omega \text{ min.}$  |
|                 | High Permittivity (Class2) Note 1 |                     | Appearance : No abnormality<br>Capacitance change : Within $\pm 12.5\%$<br>Dissipation factor : $5.0\%$ max.<br>Insulation resistance : $50 \text{ M}\Omega/\mu\text{F}$ or $1000 \text{ M}\Omega$ whichever is smaller.  |

|                          |                 |   |                          |   |
|--------------------------|-----------------|---|--------------------------|---|
| Test Methods and Remarks |                 | Class 1                                 |                          | Class 2   |
|                          |                 | Standard                                | High Frequency Type      | All items   |
|                          | Preconditioning | None                                    |                          | Thermal treatment ( at $150^\circ\text{C}$ for 1 hr) Note 2 |
|                          | Temperature     | $40 \pm 2^\circ\text{C}$                | $60 \pm 2^\circ\text{C}$ | $40 \pm 2^\circ\text{C}$                                    |
|                          | Humidity        | 90 to 95%RH                             |                          | 90 to 95%RH   |
|                          | Duration        | $500 + 24 / - 0$ hrs                    |                          | $500 + 24 / - 0$ hrs  |
|                          | Recovery        | 6 to 24 hrs (Standard condition) Note 5 |                          | $24 \pm 2$ hrs (Standard condition) Note 5                  |

16. Humidity Loading

|                 |                                   |                     |  |
|-----------------|-----------------------------------|---------------------|--|
| Specified Value | Temperature Compensating(Class1)  | Standard            | Appearance : No abnormality<br>Capacitance change : Within $\pm 7.5\%$ or $\pm 0.75\text{pF}$ , whichever is larger.<br>Q : $C < 30\text{pF} : Q \geq 100 + 10C/3$<br>$C \geq 30\text{pF} : Q \geq 200 (C : \text{Nominal capacitance})$<br>Insulation resistance : $500 \text{ M}\Omega \text{ min.}$ |
|                 |                                   | High Frequency Type | Appearance : No abnormality<br>Capacitance change : $C \leq 2\text{pF} : \text{Within } \pm 0.4 \text{ pF}$<br>$C > 2\text{pF} : \text{Within } \pm 0.75 \text{ pF}$<br>(C:Nominal capacitance)<br>Insulation resistance : $500 \text{ M}\Omega \text{ min.}$  |
|                 | High Permittivity (Class2) Note 1 |                     | Appearance : No abnormality<br>Capacitance change : Within $\pm 12.5\%$<br>Dissipation factor : $5.0\%$ max.<br>Insulation resistance : $25 \text{ M}\Omega/\mu\text{F}$ or $500 \text{ M}\Omega$ whichever is smaller.  |

|                          |   |                          |  |   |
|--------------------------|---|--------------------------|--|---|
| Test Methods and Remarks |   | Class 1                  |  | Class 2   |
|                          |   | Standard                 | High Frequency Type                        | All items   |
|                          | Preconditioning                         | None                     |  | Voltage treatment<br>(Rated voltage are applied for 1 hour at $40^\circ\text{C}$ ) Note 3 |
|                          | Temperature                             | $40 \pm 2^\circ\text{C}$ | $60 \pm 2^\circ\text{C}$                   | $40 \pm 2^\circ\text{C}$  |
|                          | Humidity                                | 90 to 95%RH              |  | 90 to 95%RH   |
|                          | Duration                                | $500 + 24 / - 0$ hrs     |  | $500 + 24 / - 0$ hrs  |
|                          | Applied voltage                         | Rated voltage            |  | Rated voltage   |
|                          | Charge/discharge current                | 50mA max.                |  | 50mA max.   |
| Recovery                 | 6 to 24 hrs (Standard condition) Note 5 |                          | $24 \pm 2$ hrs (Standard condition) Note 5 |   |

► This catalog contains the typical specification only due to the limitation of space. When you consider the purchase of our products, please check our specification. For details of each product (characteristics graph, reliability information, precautions for use, and so on), see our Web site (<http://www.ty-top.com/>).

17. High Temperature Loading

|                 |                                   |                     |  |
|-----------------|-----------------------------------|---------------------|--|
| Specified Value | Temperature Compensating(Class1)  | Standard            | Appearance : No abnormality<br>Capacitance change : Within $\pm 3\%$ or $\pm 0.3\text{pF}$ , whichever is larger.<br>Q : $C < 10\text{pF}$ : $Q \geq 200 + 10C$<br>$10 \leq C < 30\text{pF}$ : $Q \geq 275 + 2.5C$<br>$C \geq 30\text{pF}$ : $Q \geq 350$ (C: Nominal capacitance)<br>Insulation resistance : 1000 M $\Omega$ min. |
|                 |                                   | High Frequency Type | Appearance : No abnormality<br>Capacitance change : Within $\pm 3\%$ or $\pm 0.3\text{pF}$ , whichever is larger.<br>Insulation resistance : 1000 M $\Omega$ min.  |
|                 | High Permittivity (Class2) Note 1 |                     | Appearance : No abnormality<br>Capacitance change : Within $\pm 12.5\%$<br>Dissipation factor : 5.0% max.<br>Insulation resistance : 50 M $\Omega\mu\text{F}$ or 1000 M $\Omega$ whichever is smaller.   |

|  |                          |                                       |                     |   |    |        |
|--|--------------------------|---------------------------------------|---------------------|---|----|--------|
| Test Methods and Remarks   |                          | Class 1                               |                     | Class 2   |    |        |
|  |                          | Standard                              | High Frequency Type | BJ, LD(※)   | C6 | B7, C7 |
|  | Preconditioning          | None                                  |                     | Voltage treatment (Twice the rated voltage shall be applied for 1 hour at 85°C, 105°C or 125°C) Note 3, 4 |    |        |
|  | Temperature              | Maximum operating temperature         |                     | Maximum operating temperature   |    |        |
|  | Duration                 | 1000+48/-0 hrs                        |                     | 1000+48/-0 hrs  |    |        |
|  | Applied voltage          | Rated voltage $\times 2$ Note 4       |                     | Rated voltage $\times 2$ Note 4   |    |        |
|  | Charge/discharge current | 50mA max.                             |                     | 50mA max.   |    |        |
|  | Recovery                 | 6 to 24hr (Standard condition) Note 5 |                     | 24 $\pm 2$ hrs (Standard condition) Note 5  |    |        |
| Note: ※LD Low distortion high value multilayer ceramic capacitor |                          |                                       |                     |   |    |        |

Note 1 The figures indicate typical specifications. Please refer to individual specifications in detail.

Note 2 Thermal treatment : Initial value shall be measured after test sample is heat-treated at 150+0/-10°C for an hour and kept at room temperature for 24 $\pm 2$ hours.

Note 3 Voltage treatment : Initial value shall be measured after test sample is voltage-treated for an hour at both the temperature and voltage specified in the test conditions, and kept at room temperature for 24 $\pm 2$ hours.

Note 4 150% of rated voltage is applicable to some items. Please refer to their specifications for further information.

Note 5 Standard condition: Temperature: 5 to 35°C, Relative humidity: 45 to 85 % RH, Air pressure: 86 to 106kPa When there are questions concerning measurement results, in order to provide correlation data, the test shall be conducted under the following condition.  
Temperature: 20 $\pm 2$ °C, Relative humidity: 60 to 70 % RH, Air pressure: 86 to 106kPa Unless otherwise specified, all the tests are conducted under the "standard condition".



# Precautions on the use of Multilayer Ceramic Capacitors

## PRECAUTIONS

### 1. Circuit Design

- ◆Verification of operating environment, electrical rating and performance**
1. A malfunction of equipment in fields such as medical, aerospace, nuclear control, etc. may cause serious harm to human life or have severe social ramifications.  
Therefore, any capacitors to be used in such equipment may require higher safety and reliability, and shall be clearly differentiated from them used in general purpose applications.
- ◆Operating Voltage (Verification of Rated voltage)**
1. The operating voltage for capacitors must always be their rated voltage or less.  
If an AC voltage is loaded on a DC voltage, the sum of the two peak voltages shall be the rated voltage or less.  
For a circuit where an AC or a pulse voltage may be used, the sum of their peak voltages shall also be the rated voltage or less.
  2. Even if an applied voltage is the rated voltage or less reliability of capacitors may be deteriorated in case that either a high frequency AC voltage or a pulse voltage having rapid rise time is used in a circuit.

### 2. PCB Design

- ◆Pattern configurations (Design of Land-patterns)**
1. When capacitors are mounted on PCBs, the amount of solder used (size of fillet) can directly affect the capacitor performance.  
Therefore, the following items must be carefully considered in the design of land patterns:
    - (1) Excessive solder applied can cause mechanical stresses which lead to chip breaking or cracking. Therefore, please consider appropriate land-patterns for proper amount of solder.
    - (2) When more than one component are jointly soldered onto the same land, each component's soldering point shall be separated by solder-resist.
- ◆Pattern configurations (Capacitor layout on PCBs)**
- After capacitors are mounted on boards, they can be subjected to mechanical stresses in subsequent manufacturing processes (PCB cutting, board inspection, mounting of additional parts, assembly into the chassis, wave soldering of the boards, etc.). For this reason, land pattern configurations and positions of capacitors shall be carefully considered to minimize stresses.

- ◆Pattern configurations (Design of Land-patterns)**
- The following diagrams and tables show some examples of recommended land patterns to prevent excessive solder amounts.

(1) Recommended land dimensions for typical chip capacitors

● Multilayer Ceramic Capacitors : Recommended land dimensions (unit: mm)

Wave-soldering

| Type |   | 107        | 212        | 316        | 325        |
|------|---|------------|------------|------------|------------|
| Size | L | 1.6        | 2.0        | 3.2        | 3.2        |
|      | W | 0.8        | 1.25       | 1.6        | 2.5        |
| A    |   | 0.8 to 1.0 | 1.0 to 1.4 | 1.8 to 2.5 | 1.8 to 2.5 |
| B    |   | 0.5 to 0.8 | 0.8 to 1.5 | 0.8 to 1.7 | 0.8 to 1.7 |
| C    |   | 0.6 to 0.8 | 0.9 to 1.2 | 1.2 to 1.6 | 1.8 to 2.5 |

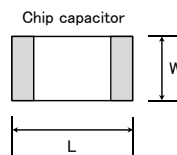
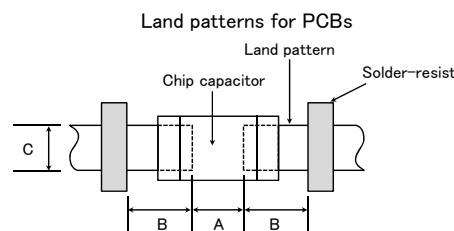

Reflow-soldering

| Type |   | 021         | 042       | 063       | 105       | 107     | 212     | 316     | 325     | 432     |
|------|---|-------------|-----------|-----------|-----------|---------|---------|---------|---------|---------|
| Size | L | 0.25        | 0.4       | 0.6       | 1.0       | 1.6     | 2.0     | 3.2     | 3.2     | 4.5     |
|      | W | 0.125       | 0.2       | 0.3       | 0.5       | 0.8     | 1.25    | 1.6     | 2.5     | 3.2     |
| A    |   | 0.095~0.135 | 0.15~0.25 | 0.20~0.30 | 0.45~0.55 | 0.8~1.0 | 0.8~1.2 | 1.8~2.5 | 1.8~2.5 | 2.5~3.5 |
| B    |   | 0.085~0.125 | 0.15~0.20 | 0.20~0.30 | 0.40~0.50 | 0.6~0.8 | 0.8~1.2 | 1.0~1.5 | 1.0~1.5 | 1.5~1.8 |
| C    |   | 0.110~0.150 | 0.15~0.30 | 0.25~0.40 | 0.45~0.55 | 0.6~0.8 | 0.9~1.6 | 1.2~2.0 | 1.8~3.2 | 2.3~3.5 |

Note: Recommended land size might be different according to the allowance of the size of the product.

● LWDC: Recommended land dimensions for reflow-soldering (unit: mm)

| Type |   | 105       | 107      | 212     |
|------|---|-----------|----------|---------|
| Size | L | 0.52      | 0.8      | 1.25    |
|      | W | 1.0       | 1.6      | 2.0     |
| A    |   | 0.18~0.22 | 0.25~0.3 | 0.5~0.7 |
| B    |   | 0.2~0.25  | 0.3~0.4  | 0.4~0.5 |
| C    |   | 0.9~1.1   | 1.5~1.7  | 1.9~2.1 |

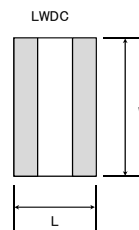

▶ This catalog contains the typical specification only due to the limitation of space. When you consider the purchase of our products, please check our specification. For details of each product (characteristics graph, reliability information, precautions for use, and so on), see our Web site (<http://www.ty-top.com/>).

(2) Examples of good and bad solder application

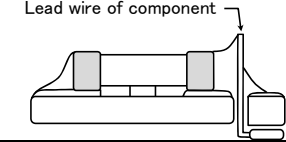
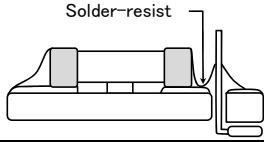
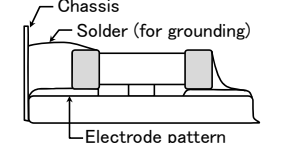
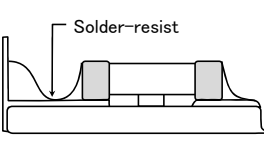
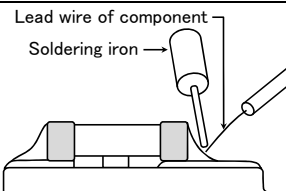
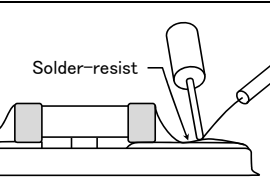
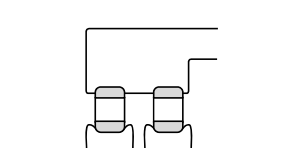
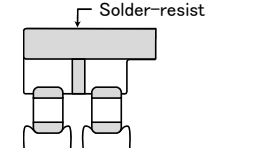
| Item  | Not recommended   | Recommended   |
|---|---|---|
| Mixed mounting of SMD and leaded components                 |  |  |
| Component placement close to the chassis                    |  |  |
| Hand-soldering of leaded components near mounted components |  |  |
| Horizontal component placement                              |  |  |

◆ Pattern configurations (Capacitor layout on PCBs)

1-1. The following is examples of good and bad capacitor layouts ; capacitors shall be located to minimize any possible mechanical stresses from board warp or deflection.

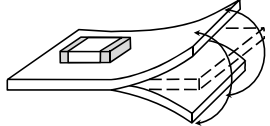
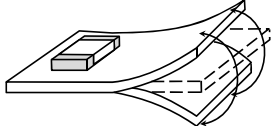
| Items               | Not recommended  | Recommended   |
|---------------------|--|---|
| Deflection of board |  |  Place the product at a right angle to the direction of the anticipated mechanical stress. |

1-2. The amount of mechanical stresses given will vary depending on capacitor layout. Please refer to diagram below.



1-3. When PCB is split, the amount of mechanical stress on the capacitors can vary according to the method used. The following methods are listed in order from least stressful to most stressful: push-back, slit, V-grooving, and perforation. Thus, please consider the PCB, split methods as well as chip location.

3. Mounting

Precautions

◆ Adjustment of mounting machine

- When capacitors are mounted on PCB, excessive impact load shall not be imposed on them.
- Maintenance and inspection of mounting machines shall be conducted periodically.

◆ Selection of Adhesives

- When chips are attached on PCBs with adhesives prior to soldering, it may cause capacitor characteristics degradation unless the following factors are appropriately checked : size of land patterns, type of adhesive, amount applied, hardening temperature and hardening period. Therefore, please contact us for further information.

◆Adjustment of mounting machine

1. When the bottom dead center of a pick-up nozzle is too low, excessive force is imposed on capacitors and causes damages. To avoid this, the following points shall be considerable.
  - (1) The bottom dead center of the pick-up nozzle shall be adjusted to the surface level of PCB without the board deflection.
  - (2) The pressure of nozzle shall be adjusted between 1 and 3 N static loads.
  - (3) To reduce the amount of deflection of the board caused by impact of the pick-up nozzle, supporting pins or back-up pins shall be used on the other side of the PCB. The following diagrams show some typical examples of good and bad pick-up nozzle placement:

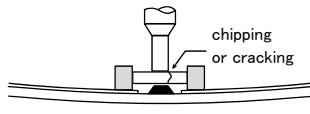
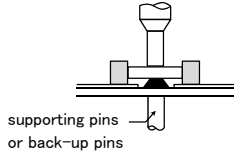
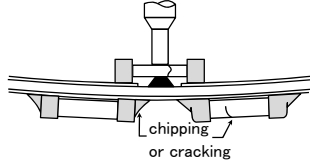
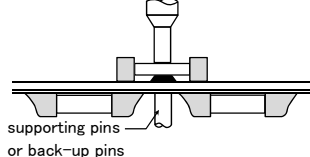
| Item                  | Improper method   | Proper method   |
|-----------------------|---|---|
| Single-sided mounting |  |  |
| Double-sided mounting |  |  |

Technical considerations

2. As the alignment pin is worn out, adjustment of the nozzle height can cause chipping or cracking of capacitors because of mechanical impact on the capacitors. To avoid this, the monitoring of the width between the alignment pins in the stopped position, maintenance, check and replacement of the pin shall be conducted periodically.

◆Selection of Adhesives

Some adhesives may cause IR deterioration. The different shrinkage percentage of between the adhesive and the capacitors may result in stresses on the capacitors and lead to cracking. Moreover, too little or too much adhesive applied to the board may adversely affect components. Therefore, the following precautions shall be noted in the application of adhesives.

- (1) Required adhesive characteristics
  - a. The adhesive shall be strong enough to hold parts on the board during the mounting & solder process.
  - b. The adhesive shall have sufficient strength at high temperatures.
  - c. The adhesive shall have good coating and thickness consistency.
  - d. The adhesive shall be used during its prescribed shelf life.
  - e. The adhesive shall harden rapidly.
  - f. The adhesive shall have corrosion resistance.
  - g. The adhesive shall have excellent insulation characteristics.
  - h. The adhesive shall have no emission of toxic gasses and no effect on the human body.
- (2) The recommended amount of adhesives is as follows;

[Recommended condition]

| Figure | 212/316 case sizes as examples   |
|--------|----------------------------------|
| a      | 0.3mm min                        |
| b      | 100 to 120 μm                    |
| c      | Adhesives shall not contact land |

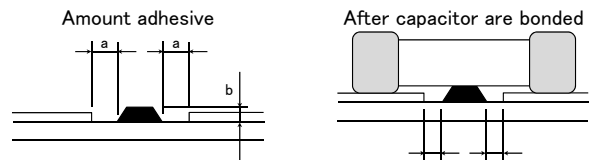

4. Soldering

◆Selection of Flux

- Since flux may have a significant effect on the performance of capacitors, it is necessary to verify the following conditions prior to use;
- (1) Flux used shall be less than or equal to 0.1 wt% ( in Cl equivalent) of halogenated content. Flux having a strong acidity content shall not be applied.
  - (2) When shall capacitors are soldered on boards, the amount of flux applied shall be controlled at the optimum level.
  - (3) When water-soluble flux is used, special care shall be taken to properly clean the boards.

Precautions

◆Soldering

Temperature, time, amount of solder, etc. shall be set in accordance with their recommended conditions.  
Sn-Zn solder paste can adversely affect MLOC reliability.  
Please contact us prior to usage of Sn-Zn solder.

Technical considerations

◆Selection of Flux

- 1-1. When too much halogenated substance (Chlorine, etc.) content is used to activate flux, or highly acidic flux is used, it may lead to corrosion of terminal electrodes or degradation of insulation resistance on the surfaces of the capacitors.
- 1-2. Flux is used to increase solderability in wave soldering. However if too much flux is applied, a large amount of flux gas may be emitted and may adversely affect the solderability. To minimize the amount of flux applied, it is recommended to use a flux-bubbling system.
- 1-3. Since the residue of water-soluble flux is easily dissolved in moisture in the air, the residues on the surfaces of capacitors in high humidity conditions may cause a degradation of insulation resistance and reliability of the capacitors. Therefore, the cleaning methods and the capability of the machines used shall also be considered carefully when water-soluble flux is used.

▶ This catalog contains the typical specification only due to the limitation of space. When you consider the purchase of our products, please check our specification. For details of each product (characteristics graph, reliability information, precautions for use, and so on), see our Web site (<http://www.ty-top.com/>).

◆ Soldering

- Ceramic chip capacitors are susceptible to thermal shock when exposed to rapid or concentrated heating or rapid cooling.
- Therefore, the soldering must be conducted with great care so as to prevent malfunction of the components due to excessive thermal shock.
- Preheating : Capacitors shall be preheated sufficiently, and the temperature difference between the capacitors and solder shall be within 130°C.
- Cooling : The temperature difference between the capacitors and cleaning process shall not be greater than 100°C.

[Reflow soldering]

【Recommended conditions for eutectic soldering】

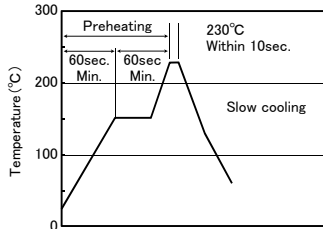

【Recommended condition for Pb-free soldering】

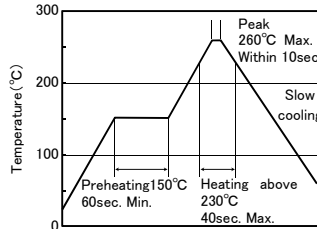

Caution

- ① The ideal condition is to have solder mass (fillet) controlled to 1/2 to 1/3 of the thickness of a capacitor.
- ② Because excessive dwell times can adversely affect solderability, soldering duration shall be kept as close to recommended times as possible. soldering for 2 times.

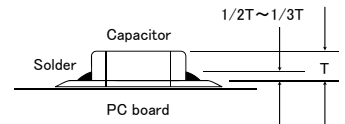

[Wave soldering]

【Recommended conditions for eutectic soldering】

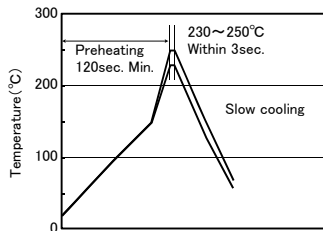

【Recommended condition for Pb-free soldering】

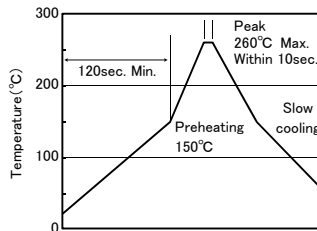

Caution

- ① Wave soldering must not be applied to capacitors designated as for reflow soldering only. soldering for 1 times.

[Hand soldering]

【Recommended conditions for eutectic soldering】



【Recommended condition for Pb-free soldering】

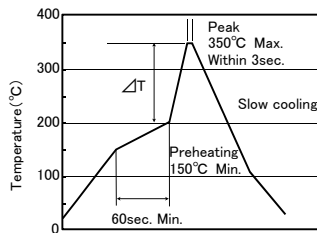

|                 |                                     |
|-----------------|-------------------------------------|
| 316type or less | $\Delta T \leq 150^{\circ}\text{C}$ |
|-----------------|-------------------------------------|

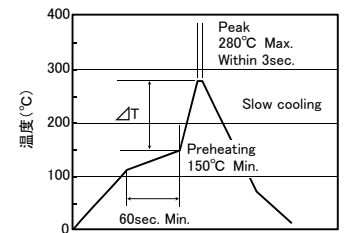

|                 |                                     |
|-----------------|-------------------------------------|
| 325type or more | $\Delta T \leq 130^{\circ}\text{C}$ |
|-----------------|-------------------------------------|

Caution

- ① Use a 50W soldering iron with a maximum tip diameter of 1.0 mm.
- ② The soldering iron shall not directly touch capacitors. soldering for 1 times.

| 5. Cleaning              |   |
|--------------------------|---|
| Precautions              | <p>◆Cleaning conditions</p> <ol style="list-style-type: none"> <li>When PCBs are cleaned after capacitors mounting, please select the appropriate cleaning solution in accordance with the intended use of the cleaning. (e.g. to remove soldering flux or other materials from the production process.)</li> <li>Cleaning condition shall be determined after it is verified by using actual cleaning machine that the cleaning process does not affect capacitor's characteristics.</li> </ol>  |
| Technical considerations | <ol style="list-style-type: none"> <li>The use of inappropriate cleaning solutions can cause foreign substances such as flux residue to adhere to capacitors or deteriorate their outer coating, resulting in a degradation of the capacitor's electrical properties (especially insulation resistance).</li> <li>Inappropriate cleaning conditions (insufficient or excessive cleaning) may adversely affect the performance of the capacitors. In the case of ultrasonic cleaning, too much power output can cause excessive vibration of PCBs which may lead to the cracking of capacitors or the soldered portion, or decrease the terminal electrodes' strength. Therefore, the following conditions shall be carefully checked;<br/>           Ultrasonic output : 20 W/l or less                      Ultrasonic frequency : 40 kHz or less<br/>           Ultrasonic washing period : 5 min. or less</li> </ol> |

| 6. Resin coating and mold |  |
|---------------------------|--|
| Precautions               | <ol style="list-style-type: none"> <li>With some type of resins, decomposition gas or chemical reaction vapor may remain inside the resin during the hardening period or while left under normal storage conditions resulting in the deterioration of the capacitor's performance.</li> <li>When a resin's hardening temperature is higher than capacitor's operating temperature, the stresses generated by the excessive heat may lead to damage or destruction of capacitors.<br/>The use of such resins, molding materials etc. is not recommended.</li> </ol> |

| 7. Handling |  |
|-------------|--|
| Precautions | <p>◆Splitting of PCB</p> <ol style="list-style-type: none"> <li>When PCBs are split after components mounting, care shall be taken so as not to give any stresses of deflection or twisting to the board.</li> <li>Board separation shall not be done manually, but by using the appropriate devices.</li> </ol> <p>◆Mechanical considerations</p> <p>Be careful not to subject capacitors to excessive mechanical shocks.</p> <p>(1) If ceramic capacitors are dropped onto a floor or a hard surface, they shall not be used.</p> <p>(2) Please be careful that the mounted components do not come in contact with or bump against other boards or components.</p> |

| 8. Storage conditions    |   |
|--------------------------|---|
| Precautions              | <p>◆Storage</p> <ol style="list-style-type: none"> <li>To maintain the solderability of terminal electrodes and to keep packaging materials in good condition, care must be taken to control temperature and humidity in the storage area. Humidity should especially be kept as low as possible.           <ul style="list-style-type: none"> <li>Recommended conditions<br/>               Ambient temperature : Below 30°C                      Humidity : Below 70% RH</li> <li>The ambient temperature must be kept below 40°C. Even under ideal storage conditions, solderability of capacitor is deteriorated as time passes, so capacitors shall be used within 6 months from the time of delivery.</li> <li>Ceramic chip capacitors shall be kept where no chlorine or sulfur exists in the air.</li> </ul> </li> <li>The capacitance values of high dielectric constant capacitors will gradually decrease with the passage of time, so care shall be taken to design circuits. Even if capacitance value decreases as time passes, it will get back to the initial value by a heat treatment at 150°C for 1 hour.</li> </ol> |
| Technical considerations | <p>If capacitors are stored in a high temperature and humidity environment, it might rapidly cause poor solderability due to terminal oxidation and quality loss of taping/packaging materials. For this reason, capacitors shall be used within 6 months from the time of delivery. If exceeding the above period, please check solderability before using the capacitors.</p>   |

※RCR-2335B (Safety Application Guide for fixed ceramic capacitors for use in electronic equipment) is published by JEITA.

Please check the guide regarding precautions for deflection test, soldering by spot heat, and so on.

# Mouser Electronics

Authorized Distributor

Click to View Pricing, Inventory, Delivery & Lifecycle Information:

## Taiyo Yuden:

[LWK107B7105KA-T](#) [LWK107B7105MA-T](#) [LWK107BJ225MV-T](#) [LWK212BJ106MD-T](#) [LWK212BJ475KD-T](#)  
[LWK316B7225KD-T](#) [UVK105CH010BW-F](#) [UVK105CH020BW-F](#) [UVK105CH030JW-F](#) [UVK105CH0R3BW-F](#)  
[UVK105CH0R4BW-F](#) [UVK105CH0R5BW-F](#) [UVK105CH0R6BW-F](#) [UVK105CH0R7BW-F](#) [UVK105CH0R8BW-F](#)  
[UVK105CH0R9BW-F](#) [UVK105CH1R1BW-F](#) [UVK105CH1R2BW-F](#) [UVK105CH1R3BW-F](#) [UVK105CH1R5BW-F](#)  
[UVK105CH1R6BW-F](#) [UVK105CH1R8BW-F](#) [UVK105CH2R2JW-F](#) [UVK105CH2R4JW-F](#) [UVK105CH2R7JW-F](#)  
[UVK105CH3R3JW-F](#) [UVK105CH3R6JW-F](#) [UVK105CH3R9JW-F](#) [UVK105CH4R3JW-F](#) [UVK105CH4R7JW-F](#)  
[UVK105CH5R1JW-F](#) [AWK105C6224MP-F](#) [AWK107C7225MV-T](#) [AWK212C6226MD-T](#) [EVK105CH010BW-F](#)  
[EVK105CH020BW-F](#) [EVK105CH030JW-F](#) [EVK105CH0R3BW-F](#) [EVK105CH0R4BW-F](#) [EVK105CH0R5BW-F](#)  
[EVK105CH0R6BW-F](#) [EVK105CH0R7BW-F](#) [EVK105CH0R8BW-F](#) [EVK105CH0R9BW-F](#) [EVK105CH1R1BW-F](#)  
[EVK105CH1R2BW-F](#) [EVK105CH1R3BW-F](#) [EVK105CH1R5BW-F](#) [EVK105CH1R6BW-F](#) [EVK105CH1R8BW-F](#)  
[EVK105CH2R2JW-F](#) [EVK105CH2R4JW-F](#) [EVK105CH2R7JW-F](#) [EVK105CH3R3JW-F](#) [EVK105CH3R6JW-F](#)  
[EVK105CH3R9JW-F](#) [EVK105CH4R3JW-F](#) [EVK105CH4R7JW-F](#) [EVK105CH5R1JW-F](#) [EWK316B7225KD-T](#)  
[EWK316B7225MD-T](#) [JWK105BJ105MP-F](#) [JWK105BJ105MV-F](#) [JWK105C7104MP-F](#) [JWK107B7105KA-T](#)  
[JWK107B7224MV-T](#) [JWK107BJ225MV-T](#) [JWK107BJ475MV-T](#) [JWK107C7105MV-T](#) [JWK212BJ226MD-T](#)  
[JWK212C6106MD-T](#) [JWK212C6475KD-T](#) [JWK212C6475MD-T](#) [JWK316BJ106KD-T](#) [AWK212BJ226MDHT](#)  
[LWK105BJ474MP-F](#) [AWK105C6474MP-F](#) [AWK105C6225MP-F](#) [EWK105BJ224MP-F](#) [AWK105C6105MP-F](#)  
[LWK105C7104MP-F](#) [LWK105C6224MP-F](#) [JWK107BJ105MV-T](#) [EWK105BJ224MPHF](#) [LWK105BJ474MPHF](#)  
[AWK105BJ105MPHF](#) [EWK105C6104MPHF](#) [LWK105C7104MPHF](#) [LWK105C6224MPHF](#) [AWK105C7224MPHF](#)  
[AWK105C6474MPHF](#) [LWK107BJ105MVHT](#) [EWK107B7474MVHT](#) [LWK107B7474MVHT](#) [AWK107C6225MVHT](#)  
[AWK107C6475MVHT](#) [LWK212BJ475KDHT](#) [LWK212BJ475MDHT](#) [JWK212C6475KDHT](#) [EWK107BJ224MV-T](#)